







metabo®



PROFESSIONAL POWER TOOL SOLUTIONS

Range of accessories



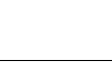



	Cutting and roughing	10	01
	Cutting discs		14
	Grinding discs		20
	Cup wheels		22

	Grinding of metal and stainless steel	23	02
	Flap discs		23
	Fleece compact polishing disc		26
	Fleece compact grinding discs		26
	Hook and loop sanding sheets		27
	Cleaning fleeces		27
	Semi-flexible hook and loop sanding sheets		27
	Fibre sanding discs		28
	Steel-wire brushes		31

	Diamond tools	33	03
	Diamond cutting discs		33
	Diamond channeling discs		37
	Diamond cup wheels		38
	Diamond tools "Dry"		40
	Accessories with Ø 76 mm		42

	Further accessories for angle grinders	44	04
--	---	-----------	-----------

	Stainless steel surface processing	55	05
	Accessories for Inox angle grinders		56
	Accessories for fillet weld grinders		58
	Accessories for burnishing machines		59
	Accessories for tube belt sanders		64
	Accessories for band files		66
	General accessories for processing stainless steel		67



	Accessories for die grinders	68	06
	Router bits		69
	Corundum mounted points		73
	Flap wheels		74
	Small grinding discs		74
	Small cutting discs		75
	Collets		75
	Flexible shafts		75

	Other metal processing	77	07
	Accessories for polishers		77
	Accessories for wet polishers		78
	Cutting discs for metal chop saws		79
	Accessories for bench grinders		80
	Accessories for bevelling tools		82
	Accessories for metal shears and nibblers		82

	Processing of concrete, masonry and plaster	84	08
	Accessories for wall chasers		84
	Accessories for renovation grinders		86
	Accessories for renovation milling machines		88

	Hammer drill bits and chisels	89	09
	SDS-plus drill bits		90
	SDS-max Drill Bits		96
	Dust extraction drill bits		100
	SDS-plus chisel bits		102
	SDS-max chisel bits		104
	Concrete core cutters		105
	Core Bits		105
	Change chuck		107

	Chucks	110	10
	Keyless chuck		111
	Geared chucks		113
	Quick system		115

	Drill bits and hole saws	118	11
	Metal drill bit		118
	Masonry drill bits/ concrete drill bits		126
	Universal drill bits/ glass drill bits		129
	Diamond drill bits		129
	Diamond core bits		130
	Wood drill bits		131
	Hole saws		135
	Drill stands		140

	Accessories for magnetic core drills	142	12
---	---	------------	-----------

	Stirrer paddles	147	13
---	------------------------	------------	-----------

	Screwdriver bits and socket wrenches	148	14
---	---	------------	-----------

	Circular saw blades and guide rails	152	15
	Circular saw blades		152
	Cross cutting rails and guide rails		165

	Jigsaw blades	169	16
---	----------------------	------------	-----------

	Sabre saw blades	182	17
---	-------------------------	------------	-----------

	Accessories for multi-tools	193	18
---	------------------------------------	------------	-----------

	Band saw blades	197	19
---	------------------------	------------	-----------

	Further accessories for semi-stationary woodworking	200	20
	Accessories for circular saws		200
	Accessories for planing machines		203
	General accessories for woodworking		204

	Grinding media on base	205	21
	Accessories for random orbital sander		206
	Accessories for sanders		212
	Hand sanding sheets		215
	Accessories for multi sanders		216
	Extraction accessories for sanding/grinding machines		217
	Accessories for triangular base-plate sanders		219
	Accessories for belt sanders		221
	Accessories for long-neck grinders		222

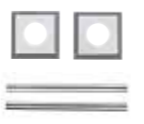
	Milling and planing	225	22
	Accessories for routers and router and grinder motor		225
	Accessories for the paint remover		228
	Planer accessory		228

	Vacuuming and extraction	229	23
	Accessories for all-purpose vacuum cleaners		231
	CordlessControl		239
	Accessories for chip and dust extraction units		241

	Further accessories for power tools	243	24
	Accessories for hot air guns		243
	Accessories for staplers		244
	Accessories for glue guns		245
	Accessories for cordless caulking gun		245
	Accessories for the cordless blind rivet gun		245
	Accessories for the cordless site light		246
	Accessories for measuring technology		246

	Accessories for garden tools	247	25
	Accessories for cordless brush cutter		247
	Accessories for cordless lawn mowers		247
	Accessories for hedge trimmers		248
	Accessories for cordless shrub and grass shears		248
	Accessories for chain saws		248
	Accessories for cordless leaf blower		248

	Battery packs and chargers	249	26
---	-----------------------------------	------------	-----------

	Transport systems	255	27
	metaBOX system		255
	Tool bags		261

	Tool safety equipment / occupational safety	262	28
---	--	------------	-----------

	Accessories for compressed air systems	264	29
	Accessories for compressors		264
	Compressed air preparation		264
	Compressed air distribution		266
	Accessories for compressed air tools		275

	Accessories for water and pump technology	279	30
---	--	------------	-----------

	Accessory sets	288	31
---	-----------------------	------------	-----------

	Accessory modules	299	32
---	--------------------------	------------	-----------

Order Number Index	304
---------------------------	------------

Ideal partner for the trade.

Professional power tool solutions. Each professional power tool comes with professional accessories. Metabo does not only offer a large selection of system accessories, but also a complete range of the required consumables. The right solution for every application.

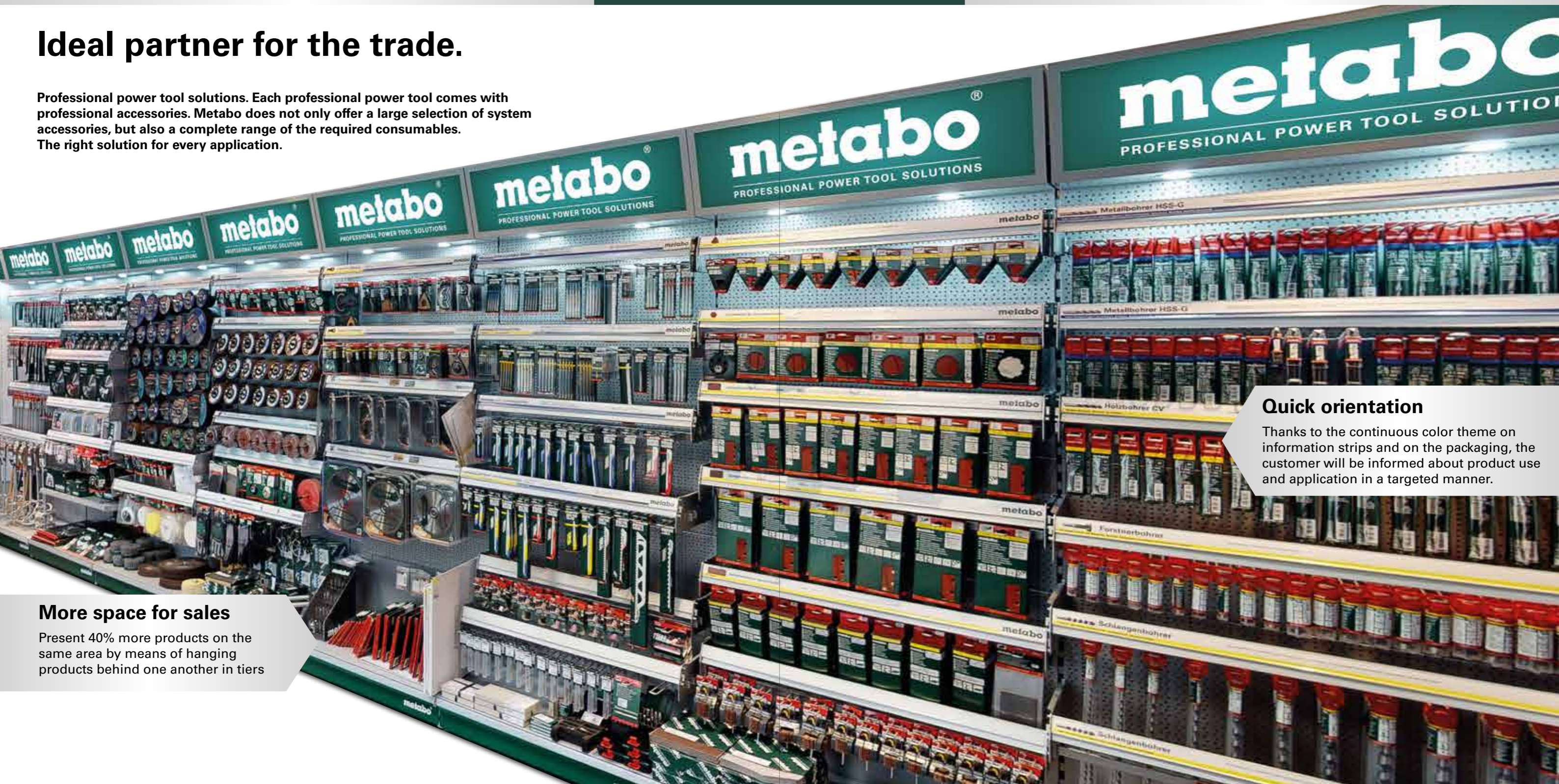

Quick orientation
Thanks to the continuous color theme on information strips and on the packaging, the customer will be informed about product use and application in a targeted manner.

More space for sales
Present 40% more products on the same area by means of hanging products behind one another in tiers



Flexible setup
The accessory presentation system adapts itself to any retail space. The individual elements can be set up quickly and easily.



Mobile sales consultation
Thanks to our mobile vans we can support you in your mobile promotions and presentations



Digital marketing
Using always up-to-date product information, images and videos we are offering modern solutions for sale at the digital point of sale.



Training
Technical consultations help the customer to find the ideal solution. Our training will help you with this.

Diverse competence

Good work results can only be achieved with powerful accessories. Therefore, all Metabo products are designed for demanding applications without any compromise. They are manufactured and controlled according to the most stringent quality standards. We offer everything from a single source: System accessories and consumables for any application.

Cutting and grinding

Clean cutting edges and smooth surfaces are guaranteed with our cutting and grinding accessories.

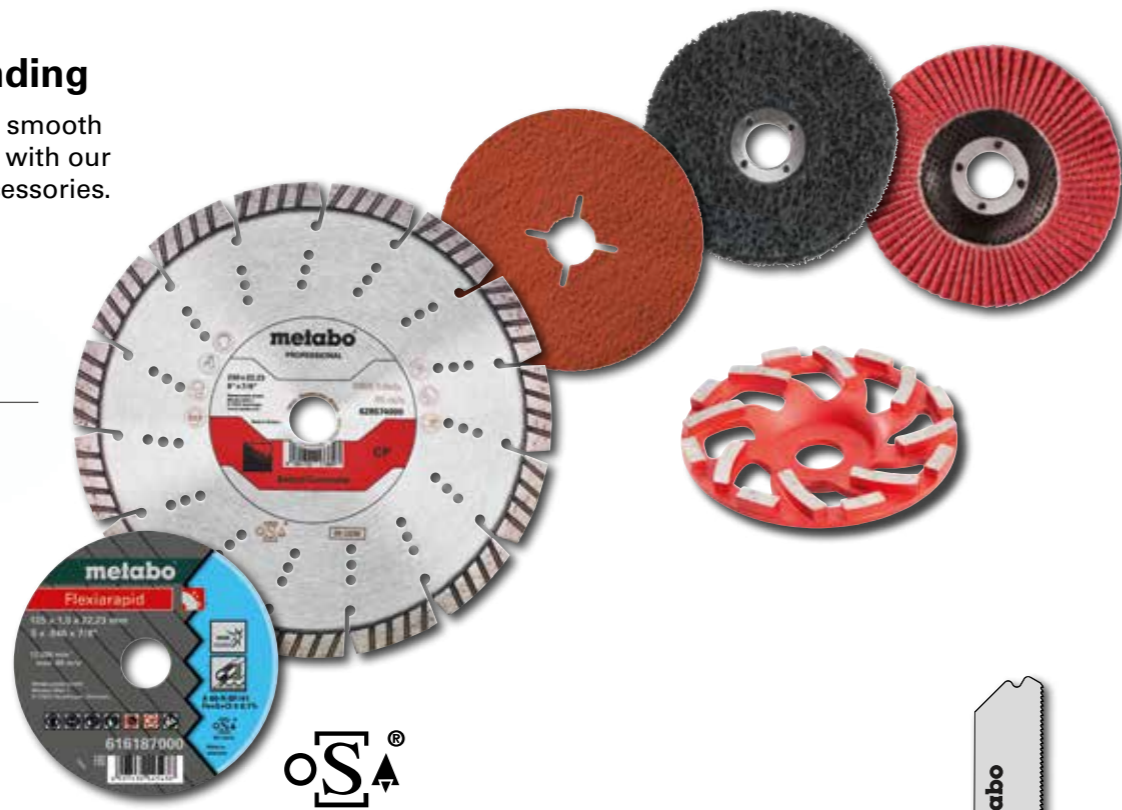

Sawing

The ideal saw blade for each application with colour coding system for fast orientation.



SDS max/plus drill bits and chisel bits

Very demanding applications become child's play with the right accessories.



Accessory sets

Everything always at hand thanks to the multitude of our accessory sets



Chucks

Precision down to the detail for all standard drills and any work process.

Made in Germany: Innovation is our tradition.

In every Metabo tool there is traditional German engineering ingenuity. Since 1924 we have been developing innovative ideas in our Nürtingen plant and have been implementing them into pioneering tools and perfect accessories for professional users directly on site. Our service, tailor-made to your requirements, also makes us a strong partner for the industrial sector.



M+ System: Machine and accessories perfectly synchronised for maximum performance.

Even during the development phase at Metabo, machines and accessories are optimally adjusted and tested to complement one another. The added benefit: Maximum performance for screwdriving, drilling, grinding, cutting and saving thanks to Metabo + System effect.

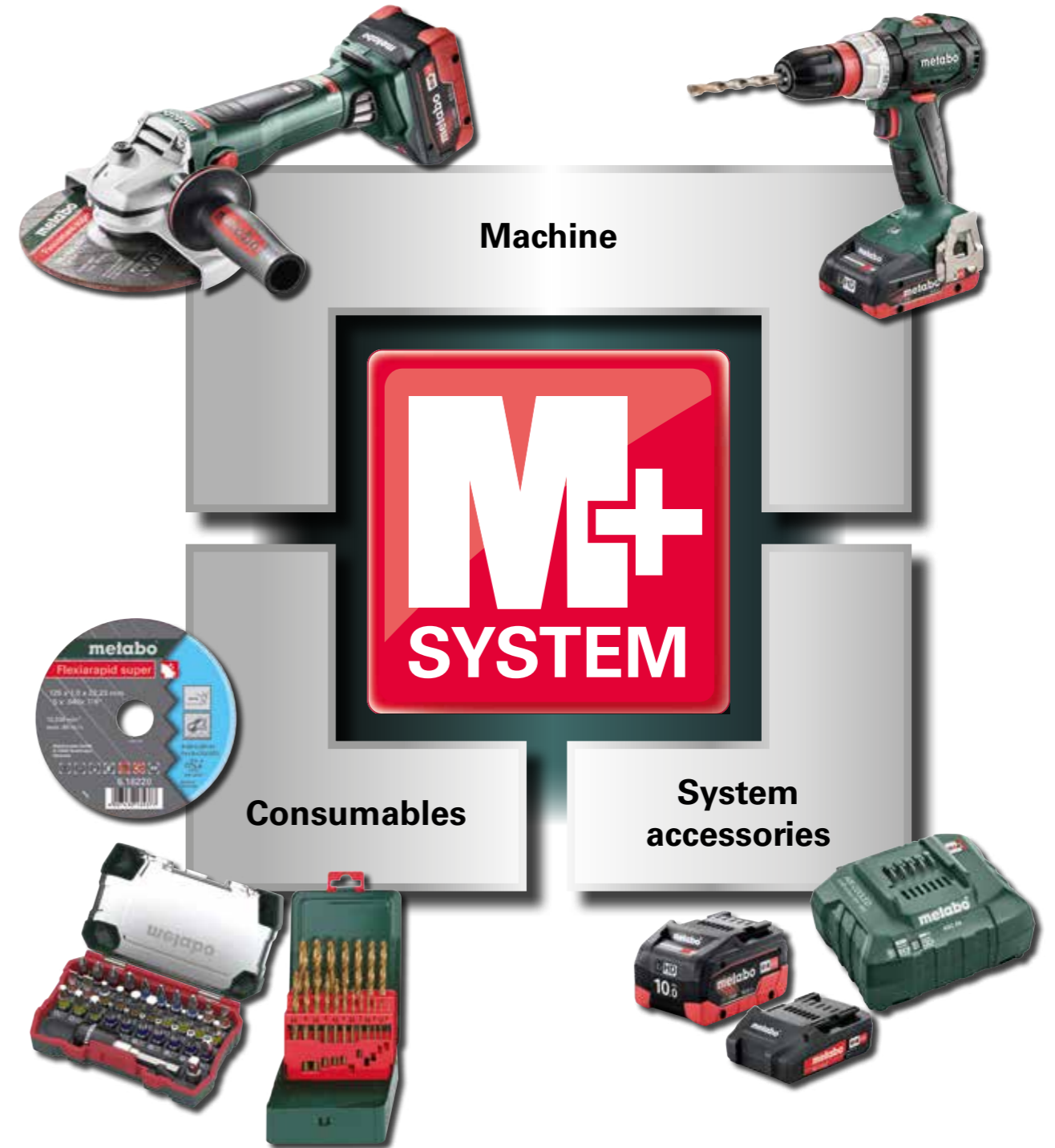

Cutting and grinding discs: The Metabo quality classes at a glance

Metabo offers you four quality grades, from which you can choose the right disc for your applications.

**»Novoflex«
»Novorapid« Inox**

Basic quality

Impress with good cutting output and material removal with good tool life.

**»Flexiamant«
»Flexiarapid« Inox**

Standard quality

Particularly uniform in cutting output and extraordinary tool life.

**»Flexiamant Super«
»Flexiarapid Super«
Inox HydroResist**

Premium quality

Extremely high cutting output with very long tool life

»M-Calibur«

Premium CER quality

Special ceramic abrasive grain technology and bonding for highest productivity and work progress

Cutting and grinding discs: Powerful and robust

The quality of cutting and grinding discs depends on several things: The grit (size, shape and quality of the abrasive grains), determines how powerful a disc is. The right ratio of bonding, filler materials and glass reinforcement determine how long the disc will last. Metabo cutting and grinding discs are manufactured in accordance with our recipes and quality specifications so that they, in combination with our machines, achieve best working results. The powerful discs permit an optimum working result in connection with long tool life and are therefore particularly economical.

Metabo product line Flexiamant super

Dimensions 230 x 2,5 x 22,23 mm
9 x 3/32 x 7/8"

Max. permitted speed 6.600 min⁻¹
max. 80 m/s

Maximum working speed

Order number 616115

Metal ring with expiry date

Clear information on the suitable materials

Specifications See below

Safety notes

- Use ear protection
- Use goggles
- Use dust mask
- Use protective gloves
- Limitations of usage

Safety standard OSA

The Symbol of Safety

Metabo cutting and grinding accessories meet the highest safety standards, international standards and safety requirements such as EN 12413 and OSA

The Metabo colour coding system

Metabo grinding wheels are colour coded according to their application area with the appropriate colour from the coding system. The catalogue carries the relevant colour bar on the left side of the grinding disc groups' table to help selection:

	Steel, sheet steel
	Stainless steel
	Aluminium, bronze, copper, brass, other NF metals
	Stone, concrete, tiles, breeze block etc.
	Pipeline

This is how to read the specification for a cutting and grinding disc:

<p>Specification The combination of letters and numbers is the genetic code of the grinding wheel.</p> <p>Abrasive A ■ For general metal processing ZA ■ Special discs for metal processing</p> <p>C Silicon carbide ■ For processing stone</p> <p>CA Ceramic ■ Special discs for processing stainless steel and metal</p>	<p>Grit The higher the number, the finer the grit. We use grain sizes of 16 – 60 for cutting and grinding discs: 16–24 Coarse 30–60 Medium</p> <p>Hardness The hardness of a grinding tool is coded alphabetically: ABC ... NOP ... RST ... Z Very soft Soft Hard Very hard</p> <p>Shape Shape 41: straight version Shape 42/27: offset version</p>	<p>Bonding B Resin bonding ■ Permitted for a circumferential speed of up to 50 m/s BF Glass-fibre reinforced resin bonding ■ Permitted for a circumferential speed of up to 80 m/s</p> <p>Example: A 24-N-BF A Aluminium oxide 24 Grit N Hard disc BF Glass-fibre reinforced resin bonding ■ A disc of this type cuts well and has a good service life when working with steel.</p>
--	---	--

Which disc is suitable for which application?

Legend	Cutting discs for												Grinding discs for																
	Hand-held angle grinders												Hand operated cutting machines (petrol)	Table mounted chop saws	Stationary cutting machines	Hand-held angle grinders													
Novoflex Good cutting performance/tool life	CA 46-U	A 30	A 30-R	A 36-T	A 60-T/A 46-T	A 46-T	A 30-P	A 46-R/A 60-R/A 30-R	A 60-U/A 46-U/A 36-U	A 46-U	A 30-O	C 30-S	C 60-T	A 24-N	A 30-R	A 36-S	A 36-R	A 30-R / A 24-M	A 30-S	C 30-S	CA 36-O	A 24	A 24-N	A 24-T	ZA 24-T	A 30-O	A 36-M	C 24-N	
Flexiamant High cutting performance/tool life	M-Calibur steel/Inox	Novoflex steel	Flexiamant steel	Flexiamant super steel	Flexiamant super steel	Novorapid Inox	Flexiamant Inox	Flexiarapid Inox	Flexiarapid super Inox	Combinator	Flexiarapid aluminium	Flexiamant super stone	Flexiamant super stone	Flexiamant super steel	Flexiamant steel	Flexiamant super steel	Flexiamant super Inox	Flexiamant super steel	Flexiamant super stone	M-Calibur steel/Inox	Novoflex steel	Flexiamant steel	Flexiamant super steel	Flexiamant super pipeline	Flexiamant super Inox	Flexiamant super aluminium	Flexiamant super stone		
Flexiamant super Very high cutting output/tool life																													
Material/application																													
Steel	■	■	■	■	■	■	■	■	■	■	■	■	■	■	■	■	■	■	■	■	■	■	■	■	■	■	■	■	
General construction steel	■	■	■	■	■	■	■	■	■	■	■	■	■	■	■	■	■	■	■	■	■	■	■	■	■	■	■	■	
Construction steel, high tensile strength	□	□	□	□	□	□	□	□	□	□	□	□	□	□	□	□	□	□	□	□	□	□	□	□	□	□	□	□	
Tool steel	■	■	■	■	■	■	■	■	■	■	■	■	■	■	■	■	■	■	■	■	■	■	■	■	■	■	■	■	
Steel sheets/thin-walled profiles	■	■	■	■	■	■	■	■	■	■	■	■	■	■	■	■	■	■	■	■	■	■	■	■	■	■	■	■	
Ductile pipes																													
Pipeline																													
Grey cast iron GG																													
Ductile cast iron GGG																													
Cast steel GG																													
Malleable cast iron GT																													
Stainless steel	■																												
Non-alloy stainless steel	■																												
High-alloy stainless steel	■																												
Stainless steel sheets/thin-walled profiles	■																												
Container construction																													
Aluminium																													
Bronze																													
Copper																													
Brass																													
Other non-ferrous metals																													
Asphalt																													
Concrete																													
Reinforced concrete																													
Pumice stone																													
Roof tiles																													
Tiles																													
Aerated concrete																													
Granite																													
Glazed tiles																													
Sand-lime brick																													
Ceramic																													
Clinkers																													
Fireclay																													
Stone																													
Clay pipes																													
Exposed aggregate concrete																													

Cutting and grinding discs "M-Calibur" for steel and stainless steel.



"M-Calibur" grinding wheels with special ceramic abrasive grain technology and bonding for highest productivity and work progress in steel and stainless steel



- Maximum number of cuts with the cutting disc "M-Calibur" (up to 3 times the service life)
- Extremely high cutting speed
- Maximum material removal with the grinding disc "M-Calibur" (up to 3x the removal than standard grinding discs)
- Extremely high material removal speed

Highest safety standards

- Exceed the requirements of all relevant safety standards EN 12413, OSA

Perfectly adjusted to the most powerful angle grinders



Particularly wide range of application





- For all steel and stainless steel applications

01
02
03
04
05
06
07
08
09
10
11
12
13
14
15
16

Cutting discs

Cutting discs for hand-held angle grinders

Quality class	Diameter x thickness x bore mm	Version	Maximum speed /min	Sales unit / packing unit	Order no.
 <p>Quality class A 60-R / A 46 R "Novorapid" Steel</p> <ul style="list-style-type: none"> Quality Novorapid: powerful entry-level class Thin cutting disc for general metal processing, especially for thin-walled materials such as pipes, metal sheets, profiles, wires etc. Good cutting performance with good tool life. Hardness: medium-hard Low material consumption, power-saving, low machine load Maximum working speed: 80 m/s 					
A 60-R	115 x 1 x 22,23	—	13.300	1/25	616505000
A 60-R	125 x 1 x 22,23	—	12.200	1/25	616506000
A 46-R	150 x 1,6 x 22,23	—	10.200	1/25	616507000
A 46-R	180 x 1,6 x 22,23	—	8.500	1/25	616508000
A 46-R	230 x 1,9 x 22,23	—	6.600	1/25	616509000
 <p>Quality class A 30 "Novoflex" steel</p> <ul style="list-style-type: none"> Quality Novoflex: powerful entry-level class Hardness: medium-hard Universal use in metal processing Good cutting performance with good tool life. Maximum working speed 80 m/s 					
A 30	100 x 2,5 x 16	—	15.300	1/25	616446000
A 30	100 x 2,5 x 16	—	15.300	1/25	616447000
A 30	115 x 2,5 x 22,23	—	13.300	1/25	616442000
A 30	115 x 2,5 x 22,23	—	13.300	1/25	616454000
A 30	115 x 3 x 22,23	—	13.300	1/25	616420000
A 30	125 x 2,5 x 22,23	—	12.200	1/25	616444000
A 30	125 x 2,5 x 22,23	—	12.200	1/25	616456000
A 30	150 x 3 x 22,23	—	10.200	1/25	616448000
A 30	180 x 3 x 22,23	—	8.500	1/25	616450000
A 30	180 x 3 x 22,23	—	8.500	1/25	616457000
A 30	230 x 3 x 22,23	—	6.600	1/25	616452000
A 30	230 x 3 x 22,23	—	6.600	1/25	616477000
 <p>Quality class A 30-R "Flexiamant" Steel</p> <ul style="list-style-type: none"> Universal disc for complete metal processing Hardness: medium High cutting output with long tool life Uniform in cutting output and tool life Maximum working speed 80 m/s 					
A 30-R	100 x 2,5 x 16	—	15.300	1/25	616742000
A 30-R	115 x 2,5 x 22,23	—	13.300	1/25	616727000
A 30-R	115 x 2,5 x 22,23	—	13.300	1/25	616770000
A 30-R	125 x 2,5 x 22,23	—	12.200	1/25	616310000
A 30-R	125 x 2,5 x 22,23	—	12.200	1/25	616732000
A 30-R	150 x 3 x 22,23	—	10.200	1/25	616121000
A 30-R	150 x 3 x 22,23	—	10.200	1/25	616313000
A 30-R	180 x 3 x 22,23	—	8.500	1/25	616123000
A 30-R	180 x 3 x 22,23	—	8.500	1/25	616300000
A 30-R	230 x 3 x 22,23	—	6.600	1/25	616127000
A 30-R	230 x 3 x 22,23	—	6.600	1/25	616302000

Quality class	Diameter x thickness x bore mm	Version	Maximum speed /min	Sales unit / packing unit	Order no.
 <p>Quality class A 60-T / A 46-T "Flexiamant Super" steel</p> <ul style="list-style-type: none"> Thin high output cutting disc especially for thin materials such as metal sheets, pipes, profiles, wires Hardness: hard Very high cutting output with good tool life Low material consumption, power-saving, low machine load Maximum working speed 80 m/s 					
A 60-T	115 x 1 x 22,23	—	13.300	1/25	616188000
A 46-T	115 x 1,6 x 22,23	—	13.300	1/25	616191000
A 60-T	125 x 1 x 22,23	—	12.200	1/25	616189000
A 46-T	125 x 1,6 x 22,23	—	12.200	1/25	616192000
 <p>Quality class A 36-T "Flexiamant Super" steel</p> <ul style="list-style-type: none"> Universal disc for complete metal processing Hardness: hard Extremely high cutting output with good tool life by using special corundums Best results using powerful angle grinders Maximum working speed 80 m/s 					
A 36-T	115 x 2 x 22,23	—	13.300	1/25	616100000
A 36-T	115 x 2 x 22,23	—	13.300	1/25	616105000
A 36-T	115 x 3 x 22,23	—	13.300	1/25	616104000
A 36-T	125 x 2 x 22,23	—	12.200	1/25	616101000
A 36-T	125 x 2 x 22,23	—	12.200	1/25	616107000
A 36-T	150 x 2 x 22,23	—	10.200	1/25	616109000
A 36-T	150 x 2 x 22,23	—	10.200	1/25	616119000
A 36-T	180 x 2 x 22,23	—	8.500	1/25	616102000
A 36-T	180 x 2 x 22,23	—	8.500	1/25	616111000
A 36-T	230 x 2,5 x 22,23	—	6.600	1/25	616103000
A 36-T	230 x 2,5 x 22,23	—	6.600	1/25	616115000
 <p>Quality class A 46-T "Novorapid" Inox</p> <ul style="list-style-type: none"> Quality Novorapid: powerful entry-level class Thin cutting disc for processing rust-free, thin-walled materials such as pipes, sheeting, profiles, wires etc. as well as for general metal processing Good cutting performance with good tool life. Hardness: hard Low material consumption, power-saving, low machine load Low in iron, sulphur and chlorine (Fe + S + Cl ≤ 0.1 %) Maximum working speed: 80 m/s 					
A 46-T	115 x 1 x 22,23	—	13.200	1/25	616270000
A 46-T	125 x 1 x 22,23	—	12.200	1/25	616271000
A 46-T	180 x 1,5 x 22,23	—	8.600	1/25	616273000
A 46-T	230 x 1,9 x 22,23	—	6.600	1/25	616274000
 <p>Quality class A 30-P "Flexiamant" Inox</p> <ul style="list-style-type: none"> Universal disc for processing stainless steels Hardness: soft High cutting output with long tool life Low in iron and sulphur <0.1% Maximum working speed 80 m/s 					
A 30-P	100 x 2,5 x 16	—	15.300	1/25	616744000
A 30-P	115 x 2,5 x 22,23	—	13.300	1/25	616737000
A 30-P	115 x 3 x 22,23	—	13.300	1/25	616741000
A 30-P	125 x 2,5 x 22,23	—	12.200	1/25	616738000
A 30-P	180 x 3 x 22,23	—	8.500	1/25	616163000
A 30-P	180 x 3 x 22,23	—	8.500	1/25	616299000
A 30-P	230 x 3 x 22,23	—	6.600	1/25	616167000



Accessory sets can be found in chapter 31, from page 288

Quality class	Diameter x thickness x bore mm	Version	Maximum speed /min	Sales unit / packing unit	Order no.
 <p>Quality class A 60-R / A 46-R / A 30-R "Flexiarapid" Inox</p> <ul style="list-style-type: none"> Thin high-output cutting disc especially for stainless, thin-walled materials such as pipes, metal sheets, profiles, wires Hardness: hard Very high cutting output with good tool life by using special corundums Low material consumption, power-saving, low machine load. Low in iron, sulphur and chlorine (Fe + S + Cl ≤ 0.1 %) Maximum working speed 80 m/s A 60-R with 1 mm thickness; A 46-R with 1.6 mm thickness; A 30-R with 1.9 mm thickness 					
A 46-R	105 x 1,6 x 16	—	15.300	1/25	616180000
A 60-R	115 x 1 x 22,23	—	13.300	1/25	616186000
A 46-R	115 x 1,6 x 22,23	—	13.300	1/25	616181000
A 60-R	125 x 1 x 22,23	—	12.200	1/25	616187000
A 46-R	125 x 1,6 x 22,23	—	12.200	1/25	616182000
A 30-R	150 x 1,6 x 22,23	—	10.200	1/25	616183000
A 30-R	180 x 1,6 x 22,23	—	8.500	1/25	616184000
A 30-R	230 x 1,9 x 22,23	—	6.600	1/25	616185000





New durable miracle: Flexiarapid Super/Combinator cutting discs with HydroResist formula

Resin-bonded grinding wheels age and lose performance over the course of time - even if they are unused. The newly developed HydroResist formula counteracts this process and sustainably ensures the performance of the discs.

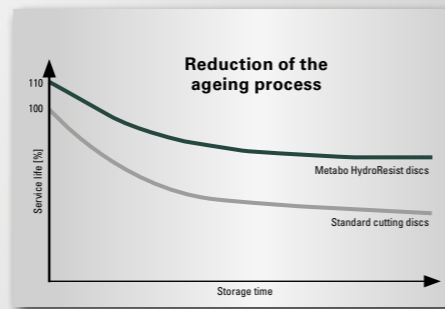
- More endurance:** increases the service life of the disc - even with high atmospheric humidity
- Less replacement costs:** 10% more cuts (per disc) by virtue of newly developed formula for optimised connection of grain and bonding agent



Quality class	Diameter x thickness x bore mm	Version	Maximum speed /min	Sales unit / packing unit	Order no.
 <p>Quality class A 36-U / A 46-U / A 60-U "Flexiarapid Super" Inox HydroResist</p> <ul style="list-style-type: none"> The super-thin high-output disc especially for processing stainless steel Super quick with very long service life thanks to the use of special corundums Low in iron, sulphur and chlorine (Fe + S + Cl ≤ 0.1 %) For all rust and acid resistant steels (V2A, Nirosta, INOX), spring steels, tool steels For use in the manufacture of vehicles, containers, car bodies, consumer units etc. Cutting discs for quiet, precise cutting, cuts without burrs Hardness: hard Maximum working speed 80 m/s 					
A 46-U	76 x 1 x 10	—	20.100	5/1	626870000
A 60-U	105 x 1 x 16	—	15.300	1/25	616210000
A 60-U	105 x 1 x 16	—	15.300	50/1	616347000
A 60-U	115 x 0,8 x 22,23	—	13.300	1/50	616208000
A 60-U	115 x 1 x 22,23	—	13.300	1/25	616216000
A 60-U	115 x 1 x 22,23	—	13.300	1/25	616217000
A 46-U	115 x 1,6 x 22,23	—	13.300	1/25	616218000
A 46-U	115 x 1,6 x 22,23	—	13.300	1/25	616219000
A 60-U	125 x 0,8 x 22,23	—	12.200	1/50	616209000
A 60-U	125 x 1 x 22,23	—	12.200	1/25	616220000
A 46-U	125 x 1,6 x 22,23	—	12.200	1/25	616222000
A 46-U	150 x 1,6 x 22,23	—	10.200	1/25	616224000
A-36-U	180 x 1,6 x 22,23	—	8.500	1/25	616226000
A-36-U	180 x 1,6 x 22,23	—	8.500	1/25	616227000
A 36-U	180 x 1,8 x 22,23	—	8.500	1/25	616230000
A 36-U	230 x 1,9 x 22,23	—	6.600	1/25	616228000
A 36-U	230 x 1,9 x 22,23	—	6.600	1/25	616229000

Quality class	Diameter x thickness x bore mm	Version	Maximum speed /min	Sales unit / packing unit	Order no.
 <p>Quality class A 46-U "Combinator" Inox HydroResist</p> <ul style="list-style-type: none"> One grinding wheel for two applications: quick cutting, and easy deburring and sanding All-purpose use for processing stainless steel and for general metal processing Low in iron, sulphur and chlorine (Fe + S + Cl ≤ 0.1 %) Hardness: hard Reduces labour costs by saving on set-up time Eliminates time-consuming disc change during mobile use. Highest standards in quality and safety thanks to the dimensional and lateral stability of the disc design (proven safety with 3 full-surface layers of material) Maximum working speed: 80 m/s 					
A 46-U Combinator Inox	76 x 1 x 22,23	—	20.100	3/1	626872000
A 46-U Combinator Inox	115 x 1,9 x 22,23	—	13.200	1/25	616500000
A 46-U Combinator Inox	125 x 1,9 x 22,23	—	12.200	1/25	616501000



- Quality class CA 46-U "M-Calibur" Inox**
- The latest generation of cutting discs with ceramic abrasive grain
 - Maximum cutting performance with extremely high tool life thanks to using ceramic special corundum and new bonding
 - Highest productivity and work progress
 - Low in iron, sulphur and chlorine (Fe + S + Cl ≤ 0.1 %)
 - For all rust and acid resistant steels (V2A, Nirosta, INOX), high-alloy steels, spring steels, tool steels.
 - Hardness: hard
 - Maximum working speed 80 m/s

CA 46-U	115 x 1,6 x 22,23	—	13.300	1/25	616285000
CA 46-U	125 x 1,6 x 22,23	—	12.200	1/25	616286000





- Quality class A 60-P / A 46 P "Flexiarapid" Alu**
- Thin high-output cutting disc especially for processing aluminium, non-ferrous metals, copper, brass, bronze etc., thin-walled materials such as pipes, metal sheets, profiles, wires
 - Hardness: medium-hard
 - High cutting output with long tool life
 - Maximum working speed 80 m/s
 - Attention: Good extraction is obligatory in closed rooms, as highly concentrated aluminium dust can lead to explosions!

A 60-P	115 x 1 x 22,23	—	13.300	1/25	616512000
A 60-P	125 x 1 x 22,23	—	12.200	1/25	616513000
A 46 P	150 x 1,6 x 22,23	—	10.200	1/25	616514000
A 46 P	180 x 1,6 x 22,23	—	8.500	1/25	616515000
A 46 P	230 x 1,9 x 22,23	—	6.600	1/25	616516000



- Quality class A 30-O "Flexiamant Super" Alu**
- Universal disc with open structure for processing non-ferrous metals such as aluminium, copper, brass, bronze ...
 - Hardness: soft
 - High cutting output with long tool life
 - Maximum working speed 80 m/s
 - Attention: Good extraction is obligatory in closed rooms, as highly concentrated aluminium dust can lead to explosions!





A 30-O	115 x 2,5 x 22,23	—	13.300	1/25	616751000
A 30-O	125 x 2,5 x 22,23	—	12.200	1/25	616752000
A 30-O	150 x 3 x 22,23	—	10.200	1/25	616753000
A 30-O	230 x 3 x 22,23	—	6.600	1/25	616126000

	Quality class	Diameter x thickness x bore mm	Version	Maximum speed /min	Sales unit / packing unit	Order no.
	Quality class C 30-S "Flexiamant Super" stone					
	<ul style="list-style-type: none"> ■ Universal disc for processing natural and artificial stone ■ Hardness: medium ■ High cutting output with long tool life ■ Maximum working speed 80 m/s 					
	C 30-S	115 x 2,5 x 22,23	—	13.300	1/25	616728000
	C 30-S	125 x 2,5 x 22,23	—	12.200	1/25	616312000
	C 30-S	125 x 2,5 x 22,23	—	12.200	1/25	616733000
	C 30-S	180 x 3 x 22,23	—	8.500	1/25	616143000
	Quality class C 60-T "Flexiamant Super" stone					
	<ul style="list-style-type: none"> ■ Super thin special disc for processing tiles, ceramic, clinkers etc. ■ Hardness: hard ■ Very high cutting output with above average tool life ■ Quick cutting time, less cutting wastage, cleaner cutting edges ■ Maximum working speed 80 m/s 					
	C 60-T	115 x 1,5 x 22,23	—	13.300	1/25	616195000
	C 60-T	125 x 1,5 x 22,23	—	12.200	1/25	616196000
	Quality class C 30-S "Flexiarapid Super" Universal					
	<ul style="list-style-type: none"> ■ Super thin special disc for processing tiles, ceramic, clinkers etc. ■ Universal use ■ Very high cutting output with above average tool life ■ Quick cutting time, less cutting wastage, cleaner cutting edges ■ Maximum working speed 80 m/s 					
	C 30-S	76 x 1 x 10	—	20.100	5/1	NEW 626871000*



Cutting discs for cutting machines/petrol cutters

	Quality class	Diameter x thickness x bore mm	Version	Maximum speed /min	Sales unit / packing unit	Order no.
	Quality class A 24 N "Flexiamant Super" steel					
	<ul style="list-style-type: none"> ■ For use in all steel processing applications, also for cast materials ■ Hardness: medium ■ High cutting output with long tool life ■ Maximum working speed 80 m/s ■ Cutting discs with 2 reinforced fabrics due to the increased side load with petrol cutters 					
	A 24-N	300 x 3,5 x 20	—	5.090	1/10	616136000
	A 24-N	300 x 3,5 x 22,2	—	5.090	1/10	616135000
	A 24-N	300 x 3,5 x 25,4	—	5.090	1/10	616137000

Cutting discs for table-top cutting machines

	Quality class	Diameter x thickness x bore mm	Version	Maximum speed /min	Sales unit / packing unit	Order no.
	Quality class A 30-R "Flexiamant" Steel					
	<ul style="list-style-type: none"> ■ For use in all steel processing applications ■ Good cutting output with good tool life in steel ■ Uniform in cutting output and tool life ■ Medium-hard version for powerful machines (machine load > 3 KW) ■ Maximum working speed 80 m/s 					
	A 30-R	355 x 3 x 25,4	—	4.365	1/10	NEW 616346000
	Quality class A 30-R / A 36-S "Flexiamant Super" steel					
	<ul style="list-style-type: none"> ■ Good cutting output with good tool life in steel ■ Hard version for powerful machines (machine load > 3 KW) ■ A 36-S: with an inside gauze for quick cuts ■ Maximum working speed 80 m/s 					
	A 30-R	300 x 2,5 x 25,4	—	5.090	1/10	616328000
	A 30-R	350 x 3 x 25,4	—	4.365	1/10	616327000
	A 36-S	350 x 3 x 25,4	—	4.365	1/10	616339000
	Quality class A 24-M "Flexiamant Super" Steel					
	<ul style="list-style-type: none"> ■ High cutting output with good tool life in steel ■ Soft version for less powerful machines (machine load <3 KW) ■ Maximum working speed 80 m/s 					
	A 24-M	350 x 3 x 25,4	—	4.365	1/10	616338000
	A 24-M	400 x 3 x 25,4	—	3.820	1/10	616215000
	Quality class A 36-R "Flexiamant Super" Inox					
	<ul style="list-style-type: none"> ■ Medium-hard special cutting disc for stainless steel ■ High cutting output with good tool life ■ Low in iron and sulphur <0.1% ■ Maximum working speed 80 m/s ■ Medium-hard version for less powerful machines (machine load <3 KW) 					
	A 36-R	350 x 3 x 25,4	—	4.365	1/10	616343000



Cutting discs for stationary cutting machines





	Quality class	Diameter x thickness x bore mm	Version	Maximum speed /min	Sales unit / packing unit	Order no.
	Quality class A 30-S "Flexiamant Super" steel					
	<ul style="list-style-type: none"> ■ Universal use in metal processing ■ Hardness: hard ■ High cutting output with long tool life ■ Maximum working speed 100 m/s ■ For powerful machines (machine load > 5 KW) 					
	A 30-S	300 x 3 x 25,4	—	6.365	1/10	616202000
	A 30-S	350 x 3,5 x 25,4	—	5.460	1/10	616203000
	A 30-S	400 x 4 x 25,4	—	4.775	1/10	616204000
	Quality class C 30-S "Flexiamant Super" stone					
	<ul style="list-style-type: none"> ■ Universal use for processing natural and artificial stone ■ Also suitable for processing non-ferrous metals ■ Hardness: hard ■ High cutting output with long tool life ■ Maximum working speed 100 m/s ■ For powerful machines (machine load > 5 KW) 					
	C 30-S	300 x 3 x 25,4	—	6.365	1/10	616212000
	C 30-S	350 x 3,5 x 25,4	—	5.460	1/10	616213000

* Self-service packaging

Grinding discs

Grinding discs for hand-held angle grinders

Quality class	Diameter x thickness x bore mm	Version	Maximum speed /min	Sales unit / packing unit	Order no.
 <p>Quality class A 24 "Novoflex" steel</p> <ul style="list-style-type: none"> Quality Novoflex: powerful entry-level class Hardness: medium-hard Universal use in metal processing Good material removal with good tool life Maximum working speed 80 m/s 					
A 24	100 x 6 x 16	—	15.300	1/25	616429000
A 24	115 x 6 x 22,23	—	13.300	1/25	616460000
A 24	125 x 6 x 22,23	—	12.200	1/25	616462000
A 24	150 x 6 x 22,23	—	10.200	1/25	616464000
A 24	180 x 6 x 22,23	—	8.500	1/10	616465000
A 24	230 x 6 x 22,23	—	6.600	1/10	616468000
 <p>Quality class A 24-N "Flexiamant" Steel</p> <ul style="list-style-type: none"> Universal disc for all metal processing requirements Hardness: medium High cutting output with long tool life Maximum working speed 80 m/s 					
A 24-N	100 x 6 x 16	—	15.300	1/25	616745000
A 24-N	115 x 6 x 22,23	—	13.300	1/25	616726000
A 24-N	115 x 6,8 x 22,23	—	13.300	1/25	616725000
A 24-N	125 x 4 x 22,23	—	12.200	1/25	616680000
A 24-N	125 x 6 x 22,23	—	12.200	1/25	616730000
A 24-N	150 x 6 x 22,23	—	10.200	1/25	616554000
A 24-N	180 x 6 x 22,23	—	8.500	1/10	616560000
A 24-N	180 x 6,8 x 22,23	—	8.500	1/10	616563000
A 24-N	180 x 8 x 22,23	—	8.500	1/10	616561000
A 24-N	230 x 6 x 22,23	—	6.600	1/10	616572000
A 24-N	230 x 8 x 22,23	—	6.600	1/10	616573000
 <p>Quality class A 24-T "Flexiamant Super" Steel</p> <ul style="list-style-type: none"> Universal disc for all metal processing requirements Especially suitable for deburring and grinding edges, also for cast processing Hardness: hard Good material removal with extremely good tool life Maximum working speed 80 m/s 					
A 24-T	115 x 6 x 22,23	—	13.300	1/25	616275000
A 24-T	125 x 6 x 22,23	—	12.200	1/25	616486000
A 24-T	150 x 6 x 22,23	—	10.200	1/25	616487000
A 24-T	180 x 6 x 22,23	—	8.500	1/10	616277000
A 24-T	230 x 6 x 22,23	—	6.600	1/10	616279000

Quality class	Diameter x thickness x bore mm	Version	Maximum speed /min	Sales unit / packing unit	Order no.
 <p>Quality class A 36-O "Flexiamant Super" Inox</p> <ul style="list-style-type: none"> Special disc for processing stainless steels Low in iron and sulphur < 0.1% Hardness: soft Very good material removal with good tool life Maximum working speed 80 m/s 					
A 36-O	100 x 6 x 16	—	15.300	1/25	616735000
A 36-O	115 x 6 x 22,23	—	13.300	1/25	616739000
A 36-O	125 x 6 x 22,23	—	12.200	1/25	616747000
A 36-O	150 x 6 x 22,23	—	10.200	1/25	616604000
A 36-O	180 x 6 x 22,23	—	8.500	1/10	616610000
A 36-O	230 x 6 x 22,23	—	6.600	1/10	616622000
 <p>Quality class CA 36-O "M-Calibur" Inox</p> <ul style="list-style-type: none"> The latest generation of grinding discs with ceramic grinding media Maximum material removal with extremely high tool life thanks to special ceramic corundum with new bonding Highest productivity and work progress Low in iron, sulphur and chlorine (Fe + S + Cl ≤ 0.1 %) For all rust and acid resistant steels (V2A, Nirosta, INOX), high-alloy steels, spring steels, tool steels. Maximum working speed: 80 m/s Hardness: medium-hard 					
CA 36-O	115 x 7 x 22,23	—	13.300	1/25	616290000
CA 36-O	125 x 7 x 22,23	—	12.200	1/25	616291000
CA 36-O	180 x 7 x 22,23	—	8.500	1/10	616292000
 <p>Quality class A 36-M "Flexiamant Super" Alu</p> <ul style="list-style-type: none"> Special disc with open structure for high material removal and good tool life Hardness: soft Best suited for processing lubricating materials such as aluminium, bronze, copper, brass Maximum working speed 80 m/s Attention: Good extraction is obligatory in closed rooms, as highly concentrated aluminium dust can lead to explosions! 					
A 36-M	115 x 6 x 22,23	—	13.300	1/25	616748000
A 36-M	125 x 6 x 22,23	—	12.200	1/25	616749000
A 36-M	180 x 6 x 22,23	—	8.500	1/10	616760000
A 36-M	230 x 6 x 22,23	—	6.600	1/10	616763000
 <p>Quality class C 24-N "Flexiamant Super" stone</p> <ul style="list-style-type: none"> Special disc for rough grinding on concrete, natural and artificial stone Hardness: soft High material removal with good tool life Maximum working speed 80 m/s 					
C 24-N	115 x 6 x 22,23	—	13.300	1/25	616729000
C 24-N	125 x 6 x 22,23	—	12.200	1/25	616731000
C 24-N	150 x 6 x 22,23	—	10.200	1/25	616654000
C 24-N	180 x 6 x 22,23	—	8.500	1/10	616660000
C 24-N	230 x 6 x 22,23	—	6.600	1/10	616672000
 <p>Quality class ZA 24-T "Flexiamant Super" pipeline</p> <ul style="list-style-type: none"> Special disc for pipeline and container construction Welded seam processing in front facing grinding Grinding out welding faults Hardness: hard Very high material removal with good tool life Maximum working speed 80 m/s 					
ZA 24-T	115 x 4 x 22,23	—	13.300	1/25	616792000
ZA 24-T	180 x 4 x 22,23	—	8.500	1/10	616795000
ZA 24-T	230 x 4 x 22,23	—	6.600	1/10	616796000

Cup wheels

Cup wheels, tapered

	Diameter x thickness x bore mm	Maximum speed /min	Sales unit / packing unit	Order no.
	Quality class A 16-Q			
	<ul style="list-style-type: none"> ■ Surface grinding in the entire metal area with angle grinders ■ Hardness: hard ■ Resin-bonded ■ Good material removal with good tool life ■ Maximum working speed 50 m/s ■ For angle grinders with grinding wheel Ø 180 mm and 230 mm 			
	110 x 55 x 22,23	8.600	1/6	616170000
	110 x 55 x 22,23	8.600	1/1	630725000*

	Quality class C 16-N			
	<ul style="list-style-type: none"> ■ For rough work, even for cast iron ■ Resin-bonded ■ Good material removal with good tool life ■ Surface grinding across the entire stone processing sector ■ Also suitable for cast iron materials and non-ferrous metals ■ Maximum working speed 50 m/s ■ For angle grinders with grinding wheel Ø 180 mm and 230 mm ■ Hardness: medium-hard 			
	110 x 55 x 22,23	8.600	1/6	616171000
	110 x 55 x 22,23	8.600	1/1	630726000*

	Quality class C 36-M			
	<ul style="list-style-type: none"> ■ For general tasks ■ Resin-bonded ■ Good material removal with good tool life ■ Surface grinding across the entire stone processing sector ■ Also suitable for cast iron materials and non-ferrous metals ■ Maximum working speed 50 m/s ■ For angle grinders with grinding wheel Ø 180 mm and 230 mm ■ Hardness: medium-hard 			
	110 x 55 x 22,23	8.600	1/6	616177000

Cup wheels, cylindrical

	Diameter x thickness x bore mm	Maximum speed /min	Sales unit / packing unit	Order no.
	Quality class A 80-M steel			
	<ul style="list-style-type: none"> ■ Surface grinding for all metal processing needs ■ Hardness: medium ■ Resin-bonded ■ Good material removal with good tool life ■ Only for dry sanding/grinding ■ Maximum working speed 50 m/s ■ For angle grinders with grinding wheel Ø 115 mm, 125 mm and 150 mm 			
	80 x 25 x 22,23	11.940	1/1	630727000*

	Quality class C 30-N stone			
	<ul style="list-style-type: none"> ■ Surface grinding for all stone processing applications ■ Hardness: medium ■ Resin-bonded ■ Good material removal with good tool life ■ Only for dry sanding/grinding ■ Maximum working speed 50 m/s ■ For angle grinders with grinding wheel Ø 115 mm, 125 mm and 150 mm 			
	80 x 25 x 22,23	11.940	1/20	629175300

* Self-service packaging

Flap discs and fibre discs with ceramic grain



The Metabo convex flap discs.



- **Extremely long tool life** with high-grade ceramic grain
 - Extremely high material removal with low effort
 - **Uniform material removal across the entire service life** with self-sharpening ceramic grain
 - **Good bonding of the ceramic grain on the carrier material**
 - **Grinding-active additional layer**
 - **Cool grinding on surfaces and edges**
 - **Fields of application:**
Processing of sheet metal, container construction, die-cast parts, pipes, bars, metal, stainless steel, high-alloy steels, titanium alloy, chrome-nickel steel, brass, bronze etc.
- Ideal also for extreme grinding jobs

- **The ideal shape for fillet welds**
Achieve the optimum finish faster
- **Extremely long tool life**
thanks to high-quality ceramic grit and/or zirconia alumina
- **Extremely high and fast material removal**
thanks to high-quality ceramic grit and/or zirconia alumina
- **Faster and more efficient work results**
thanks to the design which is ideally adapted to fillet welds, also suitable for surface grinding
- **Particularly long service life**
thanks to the use of ceramic grit and/or zirconia alumina and the high number of lamellae
- **Specially shaped flap disc**
with lamellae that are rounded off towards the outer edges,
→ suitable for all angle grinders
- **Maximum working speed 80 m/s**

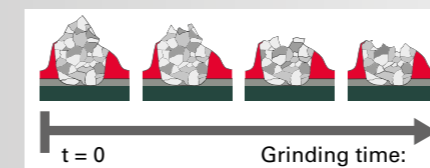



In the ceramic grit, fine aluminium oxide (Al₂O₃) crystals are bonded to each other by means of a sintering process. The grinding forces cause the micro crystals to break off during the grinding process so that the grinding grit always gets new, sharp cutting edges.



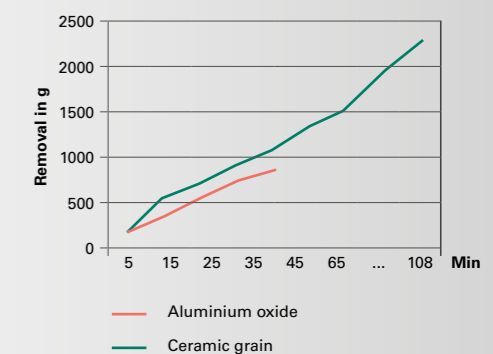

	Removed material after the end of the grinding time
Aluminium oxide	890,0 g
Ceramic grain	2295,0 g

A ceramic grit fibre disc manages 2.5 times the removal of an aluminium oxide disc



Flap disc							
	Diameter x bore mm	Grit	Version	Maximum speed /min	Sales unit / packing unit	Order no.	
 <p>Quality class aluminium oxide "Flexiamant"</p> <ul style="list-style-type: none"> ■ Suitable for rough and intermediate grinding of steel, non-ferrous metals, wood and plastics ■ High lamellar lining on fibreglass plate ■ Uniform grinding capacity ■ Cool grinding ■ Low noise level ■ Uniform grinding result, comfortable grinding with only low vibration ■ Maximum working speed 80 m/s ■ Tilted version: angle of attack 7-9° 	115 x 22,23	P 40	⤴	13.300	1/10	624391000	
	115 x 22,23	P 60	⤴	13.300	1/10	624392000	
	115 x 22,23	P 80	⤴	13.300	1/10	624393000	
	115 x 22,23	P 120	⤴	13.300	1/10	624394000	
	125 x 22,23	P 40	⤴	12.200	1/10	624395000	
	125 x 22,23	P 60	⤴	12.200	1/10	624396000	
	125 x 22,23	P 80	⤴	12.200	1/10	624397000	
	125 x 22,23	P 120	⤴	13.300	1/10	624398000	
	 <p>Quality class zirconia alumina "Novoflex"</p> <ul style="list-style-type: none"> ■ Suitable for rough and intermediate grinding in all fields of metalworking including stainless steel, steel, cast iron, and sheet steel ■ Quality "Novoflex": powerful entry-level class ■ Uniform grinding capacity ■ Cool grinding ■ Uniform grinding result, comfortable grinding with only low vibration ■ Most suitable for processing stainless steels ■ Maximum working speed 80 m/s ■ Tilted version: angle of attack 7-9° 	115 x 22,23	P 40	⤴	13.300	1/10	623175000
		115 x 22,23	P 60	⤴	13.300	1/10	623176000
115 x 22,23		P 80	⤴	13.300	1/10	623177000	
115 x 22,23		P 120	⤴	13.300	1/10	623178000	
125 x 22,23		P 40	⤴	12.200	1/10	623195000	
125 x 22,23		P 60	⤴	12.200	1/10	623196000	
125 x 22,23		P 80	⤴	12.200	1/10	623197000	
125 x 22,23		P 120	⤴	12.200	1/10	623198000	
178 x 22,23		P 40	⤴	8.500	1/10	623112000	
178 x 22,23		P 60	⤴	8.500	1/10	623114000	
 <p>Quality class zirconia alumina "Flexiamant"</p> <ul style="list-style-type: none"> ■ Suitable for rough and intermediate grinding in all fields of metalworking including stainless steel, steel, cast iron, and sheet steel ■ High lamellar lining on fibreglass plate ■ Uniform grinding capacity ■ Cool grinding ■ Low noise level ■ Uniform grinding result, comfortable grinding with only low vibration ■ Most suitable for processing stainless steels ■ Maximum working speed 80 m/s; tilted version: angle of attack 7-9° 	76 x 10	P 60	⤴	20.100	1/1	NEW 626875000*	
	76 x 10	P 80	⤴	20.100	1/1	NEW 626876000*	
	115 x 22,23	P 40	⤴	13.300	1/10	624241000	
	115 x 22,23	P 60	⤴	13.300	1/10	624243000	
	115 x 22,23	P 80	⤴	13.300	1/10	624244000	
	115 x 22,23	P 120	⤴	13.300	1/10	624239000	
	125 x 22,23	P 40	⤴	12.200	1/10	624275000	
	125 x 22,23	P 60	⤴	12.200	1/10	624277000	
	125 x 22,23	P 80	⤴	12.200	1/10	624278000	
	125 x 22,23	P 120	⤴	12.200	1/10	624279000	
	178 x 22,23	P 40	⤴	8.500	1/10	624256000	

* Self-service packaging

	Diameter x bore mm	Grit	Version	Maximum speed /min	Sales unit / packing unit	Order no.	
 <p>Quality class ceramic "Flexiamant Super"</p> <ul style="list-style-type: none"> ■ Extremely high material removal with little effort thanks to the self-sharpening ceramic grain. ■ Excellent results for surface and edge grinding of steel and stainless steel. Ideal for extreme grinding jobs like processing high-alloy steels, titanium alloys, nickel-based alloys as well as chromium and chromium-nickel steels, brass and bronze thanks to high load capacity. ■ Very high tool life; cool grinding on surfaces and edges ■ Uniform grinding result, comfortable grinding with only low vibration ■ Maximum working speed 80 m/s ■ Tilted version: angle of attack 7-9° 	178 x 22,23	P 60	⤴	8.500	1/10	624258000	
	178 x 22,23	P 80	⤴	8.500	1/10	624259000	
	178 x 22,23	P 120	⤴	8.500	1/10	624276000	
	115 x 22,23	P 40	⤴	13.300	1/10	624246000	
	115 x 22,23	P 60	⤴	13.300	1/10	624247000	
	115 x 22,23	P 80	⤴	13.300	1/10	624248000	
	125 x 22,23	P 40	⤴	12.200	1/10	624475000	
	125 x 22,23	P 60	⤴	12.200	1/10	624477000	
	125 x 22,23	P 80	⤴	12.200	1/10	624478000	
	178 x 22,23	P 40	⤴	8.500	1/10	624356000	
	178 x 22,23	P 60	⤴	8.500	1/10	624358000	
	178 x 22,23	P 80	⤴	8.500	1/10	624359000	
	 <p>Quality class zirconia alumina "Flexiamant Convex"</p> <ul style="list-style-type: none"> ■ Specially shaped flap disc with lamellae that are rounded off towards the outer edges. ■ Grinding media: Zirconia alumina ■ Thanks to the special design it is particularly suited for processing fillet welds; making faster and more efficient processing possible; also suitable for surface grinding ■ High material removal with very high tool life thanks to the use of zirconia alumina ■ Suitable for processing stainless steel and steel ■ Uniform grinding result, comfortable grinding with only low vibration ■ Maximum working speed 80 m/s 	115 x 22,23	P 40	⤴	13.300	1/10	626166000
		115 x 22,23	P 60	⤴	13.300	1/10	626167000
115 x 22,23		P 80	⤴	13.300	1/10	626168000	
125 x 22,23		P 40	⤴	12.200	1/10	626169000	
125 x 22,23		P 60	⤴	12.200	1/10	626170000	
125 x 22,23		P 80	⤴	12.200	1/10	626171000	
 <p>Quality class ceramic "Flexiamant Super Convex"</p> <ul style="list-style-type: none"> ■ Specially shaped flap disc with lamellae that are rounded off towards the outer edges. ■ Thanks to the special design it is particularly suited for processing fillet welds; making faster and more efficient processing possible; also suitable for surface grinding ■ Very high material removal with very high tool life thanks to the use of ceramic grain. ■ Cool cut for materials with poor thermal conduction ■ For grinding of steel and stainless steel. Ideal for extreme grinding jobs like processing high-alloy steels, titanium alloys, nickel-based alloys as well as chromium and chromium-nickel steels, brass and bronze thanks to high load capacity. ■ Uniform grinding result, comfortable grinding with only low vibration ■ Maximum working speed 80 m/s 	125 x 22,23	P 40	⤴	12.200	1/10	626462000	
	125 x 22,23	P 60	⤴	12.200	1/10	626463000	
	125 x 22,23	P 80	⤴	12.200	1/10	626464000	
	150 x 22,23	P 40	⤴	10.200	1/10	626490000	
	150 x 22,23	P 60	⤴	10.200	1/10	626491000	
	150 x 22,23	P 80	⤴	10.200	1/10	626492000	
	125 x 22,23	P 60	⤴	12.200	1/10	626460000	
	125 x 22,23	P 80	⤴	12.200	1/10	626461000	
	150 x 22,23	P 60	⤴	10.200	1/10	626488000	
	150 x 22,23	P 80	⤴	10.200	1/10	626489000	

Combination flap disc - KLS



- Made from high-quality pink aluminium oxide fabric in combination with high-quality nylon web.
- For removal of material to fine polish in a single process. Very even grinding/polishing result with good material removal.
- For processing weld seams for example, and for grinding or polishing. For removing minor scratches and damage to the work piece.
- Suitable for grinding, cleaning and finishing work on stainless steel, steel, coloured and light metals, titanium alloys.
- Maximum working speed: 80 m/s
- Recommended speed: 3,000 /min

Diameter x bore mm	Grit	Sales unit / packing unit	Order no.
125 x 22,23	Coarse	1 / 1	626369000*
125 x 22,23	Coarse	1 / 5	626415000
125 x 22,23	Medium	1 / 1	626370000*
125 x 22,23	Medium	1 / 5	626416000

Fleece compact polishing discs »Unitized« - VKS



- Made of compacted fleece material on a fibreglass plate
- For cleaning and polishing surfaces, for smoothing weld seams; reduces the number of working stages required
- For alloy and high-alloy steels, coloured and light metals, chrome and nickel steels, titanium, steels
- Max. speed: 8,000 /min; 52 m/s
- Recommended speed: 3,000 /min

Diameter x thickness x bore mm	Grit	Sales unit / packing unit	Order no.
125 x 22,23	Very fine	1 / 1	626368000*
125 x 22,23	Very fine	1 / 5	626417000

Fleece compact grinding discs »Unitized« - VKS-ZK



- Several layers of pressed fleece material, soaked with resin-bonded abrasive grain (zirconia alumina)
- The addition of abrasive grain covers a range of applications from deburring to soft and flexible finishing jobs. It is suited for deburring, smoothing of weld seams, precise cleaning and finishing of surfaces.
- For alloy and high-alloy steels, coloured and light metals, chrome and nickel steels, titanium, steels
- Profiling of the grinding media possible for precise working. Very low grinding of the processed material.
- Bore 22.23 mm (for angle grinder)
- Max. 10,000/min; recommended speed: 3,000/min

Diameter x thickness x bore mm	Grit	Sales unit / packing unit	Order no.
125 x 6 x 22,23	Coarse	1 / 5	626482000
125 x 6 x 22,23	Medium	1 / 5	626483000

Hook and loop backing pad "Metabo Pyramid"



- Hook and loop, with flexible intermediate layer, foam-moulded; for attaching polishing and sanding accessories
- Sanding pad for polishing and medium-hard grinding jobs. Especially recommended for Metabo Pyramid hook and loop sanding sheets

Female thread	Diameter mm	Thickness mm	Sales unit	Order no.
5/8 "	123	3	1	623298000*
M 14	123	3	1	623300000*

"Metabo Pyramid" hook and loop sanding sheets



- 3-dimensional structure of the grinding media (pyramid-shaped).
- High material removal with, at the same time, a very even and fine grinding result. Long service life. Faster progress when compared to tradition grinding media thanks to the considerable reduction in the number of working stages.
- For removing scratches, mill scale on stainless steel. Preparation for polishing.
- Suitable for use throughout the metal industry; especially for stainless steels, titanium, cobalt, nickel, chrome alloys.

Diameter mm	Grit	Sales unit / packing unit	Order no.
125	P 120 (A 160)	1 / 5	626371000*
125	P 280 (A 65)	1 / 5	626372000*
125	P 400 (A 45)	1 / 5	626373000*
125	P 600 (A 30)	1 / 5	626374000*
125	P 1200 (A 16)	1 / 5	626403000*
125	P 2000 (A 6)	1 / 5	626404000*

Hook and loop fleece compact discs "Unitized" - VKS



- Made from pressed fleece material with hook and loop
- For cleaning and polishing surfaces, for smoothing weld seams; reduces the number of working stages required
- For alloy and high-alloy steels, coloured and light metals, chrome and nickel steels, titanium, steels

Diameter x bore mm	Grit	Sales unit / packing unit	Order no.
125	Very fine	1 / 1	626375000*

Cleaning Fleeces



- For the removal of light rust, paint / varnish on metal, cleaning weld seams / steel / copper / aluminium / brass, sanding steel and texturing wood.
- Maximum working speed: 63 m/s
- Recommended speeds at Ø 115 mm: 2,900 /min, Ø 125 mm: 2,700 /min

Diameter x bore mm	Sales unit	Order no.
115 x 22,23	1	624346000*
125 x 22,23	1	624347000*

Semi-flexible sanding sheets



- **Semi-flexible sanding sheet**
- Suitable for use on masonry and stone work
- Grinding media: SiC (silicone carbide); maximum working speed: 80/s
- For use with the elastic backing pad 623279000
- Diameter: 115 mm
- Grit: C 24
- Material suitability: stone
- Sales unit: 1

Order no.
624873000

Fibre sanding discs

Diameter x bore mm	Grit	Maximum speed /min	Sales unit / packing unit	Order no.
 <p>Aluminium oxide, hole type: round hole, slotted</p> <ul style="list-style-type: none"> ■ Suitable for use throughout the metal industry ■ For rough and fine grinding jobs ■ Processing weld joints, removing rust, deburring ■ High material removal with good tool life ■ Even grinding result ■ Maximum working speed 80 m/s ■ Fibre discs for clamping on backing pad! 				
115 x 22,23	P 16	13.300	1/25	624135000
115 x 22,23	P 24	13.300	1/25	624136000
115 x 22,23	P 36	13.300	1/25	624145000
115 x 22,23	P 40	13.300	1/25	624137000
115 x 22,23	P 60	13.300	1/25	624138000
115 x 22,23	P 80	13.300	1/25	624139000
115 x 22,23	P 120	13.300	1/25	624141000
115 x 22,23	P 150	13.300	1/25	624142000
115 x 22,23	P 180	13.300	1/25	624143000
125 x 22,23	P 16	12.200	1/25	624223000
125 x 22,23	P 24	12.200	1/25	624218000
125 x 22,23	P 36	12.200	1/25	624216000
125 x 22,23	P 40	12.200	1/25	624219000
125 x 22,23	P 60	12.200	1/25	624220000
125 x 22,23	P 80	12.200	1/25	624221000
125 x 22,23	P 120	12.200	1/25	624224000
125 x 22,23	P 180	12.200	1/25	624226000
180 x 22,23	P 16	8.500	1/25	624123000
180 x 22,23	P 24	8.500	1/25	624103000
180 x 22,23	P 30	8.500	1/25	624124000
180 x 22,23	P 36	8.500	1/25	624122000
180 x 22,23	P 40	8.500	1/25	624104000
180 x 22,23	P 50	8.500	1/25	624102000
180 x 22,23	P 60	8.500	1/25	624105000
180 x 22,23	P 80	8.500	1/25	624106000
180 x 22,23	P 120	8.500	1/25	624101000
230 x 22,23	P 24	6.600	1/25	624227000
230 x 22,23	P 40	6.600	1/25	624228000

 <p>Zirconia alumina, hole type: round hole, slotted</p> <ul style="list-style-type: none"> ■ Suitable for use throughout the metal industry ■ For rough and fine grinding jobs ■ Especially for processing stainless steel ■ High material removal with good tool life ■ Even grinding result ■ Maximum working speed 80 m/s ■ Fibre discs for clamping on backing pad! 				
115 x 22,23	P 36	13.300	1/25	622971000
115 x 22,23	P 40	13.300	1/25	622972000
115 x 22,23	P 50	13.300	1/25	622973000
115 x 22,23	P 60	13.300	1/25	622974000
115 x 22,23	P 80	13.300	1/25	622975000
115 x 22,23	P 120	13.300	1/25	622977000
125 x 22,23	P 36	12.200	1/25	622981000

Diameter x bore mm	Grit	Maximum speed /min	Sales unit / packing unit	Order no.
125 x 22,23	P 40	12.200	1/25	622982000
125 x 22,23	P 60	12.200	1/25	622984000
125 x 22,23	P 80	12.200	1/25	622985000
125 x 22,23	P 100	12.200	1/25	622986000
125 x 22,23	P 120	12.200	1/25	622987000
180 x 22,23	P 36	8.500	1/25	622991000
180 x 22,23	P 40	8.500	1/25	622992000
180 x 22,23	P 60	8.500	1/25	622994000
180 x 22,23	P 80	8.500	1/25	622995000
180 x 22,23	P 120	8.500	1/25	622997000

 <p>Ceramic, hole type: round hole, slotted</p> <ul style="list-style-type: none"> ■ Self-sharpening ceramic grain for extremely high material removal with little effort ■ Excellent results for surface grinding of steel and stainless steel. Ideal for extreme grinding jobs such as processing high-alloy steels, titanium alloys, nickel-based alloys as well as chromium and chromium-nickel steels, brass and bronze, thanks to high load capacity. ■ Very high tool life; cool grinding ■ Ceramic filter discs achieve their best performance on powerful angle grinders with increased down pressure. ■ Fibre discs for clamping on backing pad! The backing pads with cooling fins are recommended for clamping the ceramic fibre sanding discs (e.g. Ø 125 mm, 623291000) ■ Maximum working speed 80 m/s 				
115 x 22,23	P 24	13.300	1/25	626150000
115 x 22,23	P 36	13.300	1/25	626151000
115 x 22,23	P 60	13.300	1/25	626152000
115 x 22,23	P 80	13.300	1/25	626153000
125 x 22,23	P 24	12.200	1/25	626154000
125 x 22,23	P 36	12.200	1/25	626155000
125 x 22,23	P 60	12.200	1/25	626156000
125 x 22,23	P 80	12.200	1/25	626157000
180 x 22,23	P 24	8.500	1/25	626158000
180 x 22,23	P 36	8.500	1/25	626159000
180 x 22,23	P 60	8.500	1/25	626160000
180 x 22,23	P 80	8.500	1/25	626161000

Backing pads for fibre sanding discs

Backing pads, standard



- Standard version for medium to rough grinding work
- For use with fibre sanding discs
- All pads with flange nut
- Maximum working speed 80 m/s
- 626418000: Special version with longer flange nut for use on Metabo angle grinders with Auto-balancer / brake

Diameter mm	Flange nut	Maximum speed /min	Sales unit / packing unit	Order no.
115	M 14	13.300	1/1	623279000*
125	M 14	12.200	1/1	623278000*
180	M 14	8.500	1/1	623275000*
230	M 14	6.600	1/1	623280000*
115	5/8 "	13.300	1/1	623283000*
125	5/8 "	12.200	1/1	623284000*
180	5/8 "	8.500	1/1	623281000*
230	5/8 "	6.600	1/1	623282000*

* Self-service packaging

Backing pad, standard 2.0



- Medium-hard backing pad for fibre discs, ideal for grinding applications with fine and medium grit
- High flexibility thanks to smooth surface
- Safe working protected from sparks thanks to innovative design, optimally adjusted to the dimensions of the standard guards from Metabo. Also suitable for Metabo angle grinder with Auto-balancer
- Flange nut included in scope of delivery
- Maximum working speed: 80 m/s

NEW

Diameter mm	Flange nut	Maximum speed /min	Sales unit / packing unit	Order no.
115	M 14	13.300	1/1	626452000*
125	M 14	12.200	1/1	626453000*
180	M 14	8.500	1/1	626454000*
115	5/8 "	13.300	1/1	626628000*
125	5/8 "	12.200	1/1	626629000*
180	5/8 "	8.500	1/1	626630000*

Backing pad with cooling fins



- For use with fibre sanding discs
- Backing pads with cooling fins are mainly used for all coarse grinding jobs. Also suitable for processing stainless steel
- The cooling fins run radially on the grinding surface reducing overheating of workpiece and backing pad
- All pads with flange nut
- Maximum working speed 80 m/s

Diameter mm	Flange nut	Maximum speed /min	Sales unit / packing unit	Order no.
115	M 14	13.300	1/1	623290000*
125	M 14	12.200	1/1	623291000*
180	M 14	8.500	1/1	623292000*

Backing pad with cooling fins 2.0



- Hard backing pad for fibre discs, ideal for rough grinding jobs
- Specially shaped cooling fins for high material removal and particularly cool grinding
- Backing pad made from heat-resistant and temperature-resistant plastic material
- Safe working protected from sparks thanks to innovative design, optimally adjusted to the dimensions of the standard guards from Metabo. Also suitable for Metabo angle grinder with Auto-balancer
- Flange nut included in scope of delivery
- Maximum working speed: 80 m/s

NEW

Diameter mm	Flange nut	Maximum speed /min	Sales unit / packing unit	Order no.
115	M 14	13.300	1/1	626455000*
125	M 14	12.200	1/1	626456000*
180	M 14	8.500	1/1	626457000*
115	5/8 "	13.300	1/1	626631000*
125	5/8 "	12.200	1/1	626632000*
180	5/8 "	8.500	1/1	626633000*

Steel-wire brushes

Steel-wire cup brushes, twisted steel



- For universal use in metal processing, e.g. for cleaning, deburring, purging, removing rust, smoothing welding seams and points, stripping slag, scales and old paint
- For processing large areas, weld seams etc.
- Edging type: twisted steel wire

Diameter mm	Female thread	Wire thickness	Maximum speed /min	Sales unit / packing unit	Order no.
65	M 14	0,35 mm	11.000	1/1	623796000*
65	M 14	0,35 mm	11.000	1/50	623796700
65	5/8 "	0,50 mm	11.000	1/1	623804000*
80	M 14	0,50 mm	8.600	1/1	623710000*
100	M 14	0,50 mm	8.600	1/1	623711000*

Steel-wire cup brushes, stainless steel, twisted



- For universal use in stainless steel processing, e.g. for smoothing welding seams and points, stripping slag, scales and old paint. Ideally suited for processing stainless steels
- Edging type: twisted stainless steel wire

Diameter mm	Female thread	Wire thickness	Maximum speed /min	Sales unit / packing unit	Order no.
65	M 14	0,35 mm	11.000	1/1	623801000*
65	5/8 "	0,35 mm	11.000	1/1	623805000*

Steel-wire cup brushes, crimped steel



- For light surface processing and deburring work in all metal processing
- For processing larger areas, weld seams, metal plates
- Edging type: crimped steel wire

Diameter mm	Female thread	Wire thickness	Maximum speed /min	Sales unit / packing unit	Order no.
75	M 14	0,30 mm	11.000	1/1	623715000*
100	M 14	0,30 mm	8.600	1/1	623719000*

Steel-wire wheel brushes, twisted steel



- For universal use in metal processing, e.g. for processing of profiles, cutting edges, gear wheels, grooves, smoothing welding seams and points, stripping slag, scales and old paint
- Especially suitable for processing narrow workpieces as well as inner edges
- Edging type: twisted steel wire
- 623803000: offset version

Diameter mm	Female thread	Wire thickness	Maximum speed /min	Sales unit / packing unit	Order no.
100	M 14	0,50 mm	12.500	1/1	623803000*
115	M 14	0,50 mm	12.500	1/1	626770000*
125	M 14	0,50 mm	12.500	1/1	626771000*

Steel-wire wheel brush, twisted steel



- For universal use in stainless steel processing, e.g. smoothing welding seams and points, stripping slag, scales and old paint
- Especially suitable for processing narrow workpieces as well as inner edges
- Most suitable for processing stainless steels
- Edging type: twisted stainless steel wire

Diameter mm	Female thread	Wire thickness	Maximum speed /min	Sales unit / packing unit	Order no.
115	M 14	0,50 mm	12.500	1/1	626778000*

Steel-wire wheel brushes, twisted steel, pipeline



- Specially developed for the professional processing of U and V-weld seams in pipeline construction, as well as for root weld seam preparation
- Edging type: twisted steel wire
- Thickness of plait: 6.0 mm

Diameter mm	Bore Ø	Wire thickness	Maximum speed /min	Sales unit / packing unit	Order no.
125	22.23	0,50 mm	12.500	1/1	626815000*
150	22.25	0,50 mm	10.000	1/1	626816000*



Diamond cutting discs for building industry and trade



High-quality and robust diamond cutting discs from Metabo meet highest safety standards, international standards (EN 13236) and safety requirements according to OSA. They guaranteed highest cutting speed in connection with a long tool life. This results in a particularly economical processing of different materials e.g. concrete, exposed aggregate concrete, clinker, hard stone, granite or other building materials. The product range offers the ideal tool for any processing task.

Diamond cutting discs are available in two quality classes

SP quality:

- Good service life
- Good cutting speed

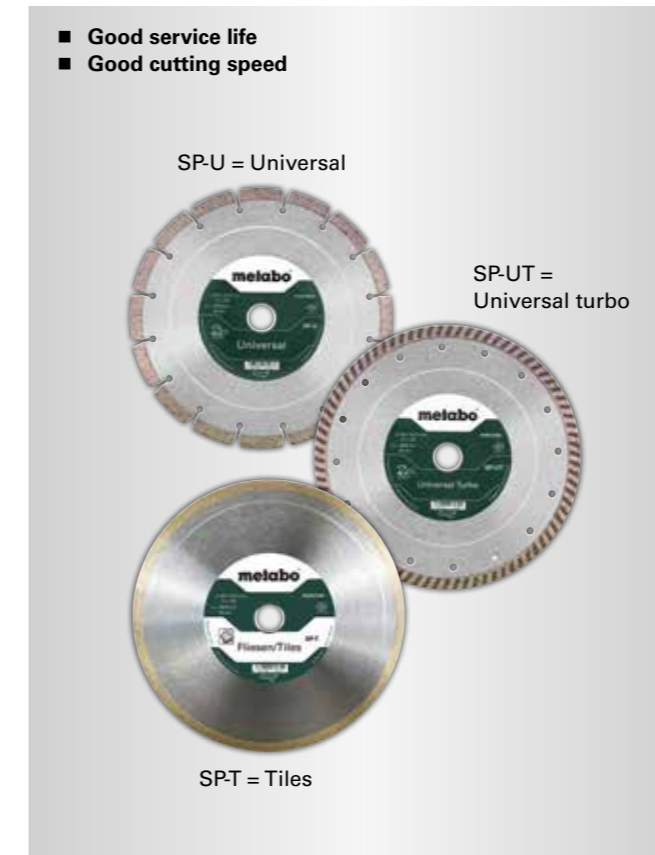

Professional quality:

- Longest tool life
- Very good cutting speed
- Laser-welded diamond segments in segmented discs

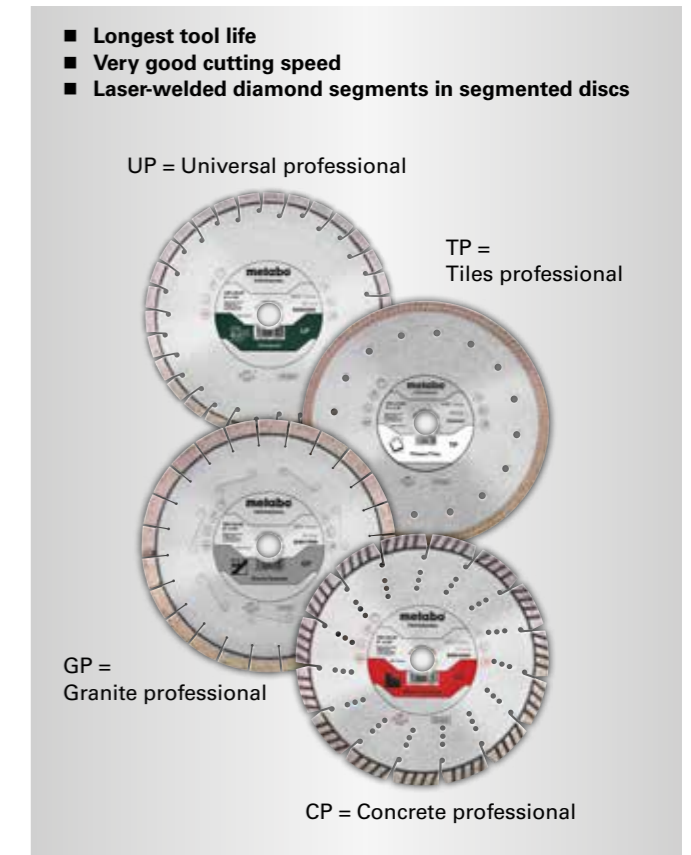

Benefits:

- Highest degree of safety guaranteed by OSA and EN 13236
- Excellent cutting speed for short cutting times thanks to high-grade diamond quality
- Long tool life
- High cutting comfort thanks to hardened steel blade
- High efficiency

Recommended use:

- Cutting with little pressure to avoid overheating of the diamond cutting disc



* Self-service packaging

01
02
03
04
05
06
07
08
09
10
11
12
13
14
15
16







The optimal tool for any application

Quality class SP:

Processing task	Material	Tool	
Aggressive, fast cutting	Concrete Aerated concrete Exposed aggregate concrete Sand stone (hart/soft) Clay tile	SP-U = Universal	
Comfortable cutting with high cutting quality	Concrete Aerated concrete Exposed aggregate concrete Sand stone (hart/soft) Clay tile	SP-UT = Universal turbo	
Comfortable cutting with high cutting quality	Glazed tiles Ceramic tiles	SP-T = Tiles	

Quality class professional:

Processing task	Material	Tool	
Aggressive, fast cutting	Concrete Aerated concrete Exposed aggregate concrete Sand stone (hart/soft) Clay tile	UP = Universal professional	
Aggressive, fast cutting	Concrete (also reinforced) Kerbs sand stone (hard) Exposed aggregate concrete	CP = Concrete professional	
Comfortable cutting with high cutting quality	Granite and tarazzo	GP = Granite professional	
Comfortable cutting with high cutting quality	Glazed tiles Ceramic tiles Fine earthenware Slate Marble	TP = Tiles professional	

Diamond cutting discs

Segmented for general building materials

	Diameter x bore mm	Segment dimensions mm	Number of segments	Maximum speed /min	Sales unit	Packaging	Order no.
 <p>Diamond cutting discs "SP" / SP-U</p> <ul style="list-style-type: none"> Universal diamond cutting disc with segmented edge for aggressive, fast cutting with high cutting performance and good tool life Well suited for all construction/building materials such as concrete, exposed aggregate concrete, hard sandstone and clay tiles. Segment height 10 mm Delivery in counter display when ordering 10 pieces (except for blister packaging) 	115 x 22,23	32,4 x 1,8 x 10	9	13.300	1	Blister	624295000*
	125 x 22,23	31,7 x 2 x 10	10	12.200	1	Blister	624296000*
	230 x 22,23	40,3 x 2,4 x 10	16	6.600	1	Blister	624298000*
	115 x 22,23	32,4 x 1,8 x 10	9	13.300	1	Cardboard box	624306000*
	125 x 22,23	31,7 x 2 x 10	10	12.200	1	Cardboard box	624307000*
	150 x 22,23	36,4 x 2 x 10	11	10.200	1	Cardboard box	624308000*
	180 x 22,23	35 x 2,2 x 10	14	8.500	1	Cardboard box	624309000*
230 x 22,23	40,3 x 2,4 x 10	16	6.600	1	Cardboard box	624310000*	

	Diameter x bore mm	Segment dimensions mm	Number of segments	Maximum speed /min	Sales unit	Packaging	Order no.
 <p>Diamond cutting discs "professional" / UP</p> <ul style="list-style-type: none"> Powerful diamond cutting disc with segmented edge for aggressive, fast cutting of hard materials with high cutting performance and very good tool life Particularly suited for general construction/building materials such as concrete, exposed aggregate concrete, hard and soft sandstones, clay tiles Clean cutting edges and high cutting speed thanks to special short teeth segments Highest safety thanks to laser-welded diamond segments. Segment height 9.10 mm. Order no. 628563000 and 628564000 with reducing bush for machines with holder 20 mm or 25.4 mm 	115 x 22,23	20 x 2,4 x 9	13	13.300	1	Cardboard box	628558000*
	125 x 22,23	20 x 2,4 x 9	15	12.200	1	Cardboard box	628559000*
	150 x 22,23	20 x 2,4 x 9	18	10.200	1	Cardboard box	628560000*
	180 x 22,23	20 x 2,6 x 9	22	8.500	1	Cardboard box	628561000*
	230 x 22,23	20 x 2,6 x 9	30	6.600	1	Cardboard box	628562000*
	300 x 20 / 25,4	24 x 2,8 x 10	32	6.300	1	Cardboard box	628563000*
	350 x 20 / 25,4	24 x 2,8 x 10	37	5.400	1	Cardboard box	628564000*

For general building materials, closed edge "Turbo"

	Diameter x bore mm	Segment dimensions mm	Number of segments	Maximum speed /min	Sales unit	Packaging	Order no.
 <p>Diamond cutting discs "SP" / SP-UT</p> <ul style="list-style-type: none"> Universal diamond cutting disc with closed edge for comfortable cutting with high cutting performance and good tool life Well suited for all construction/building materials such as concrete, exposed aggregate concrete, hard sandstone and clay tiles. Clean cutting edges without material chipping Segment height 10 mm Delivery in counter display when ordering 10 pieces 	115 x 22,23	2,2 x 10		13.300	1	Cardboard box	628551000*
	125 x 22,23	2,2 x 10		12.200	1	Cardboard box	628552000*
	180 x 22,23	2,2 x 10		8.500	1	Cardboard box	628553000*
	230 x 22,23	2,6 x 10		6.600	1	Cardboard box	628554000*

* Self-service packaging

For working on joints, closed edge "Turbo"

	Diameter x bore mm	Segment dimensions mm	Number of segments	Maximum speed /min	Sales unit	Packaging	Order no.
 <p>Diamond channeling disc "professional" / UP-TP</p> <ul style="list-style-type: none"> Particularly suited for joints in plaster and masonry Sintered cutting edge Segment height: 10.0 mm; disc width: 6.0 mm; maximum working speed 80 m/s <p>NEW</p>	125 x 22,23	10		13.200	1	Cardboard box	624304000



For concrete; segmented



	Diameter x bore mm	Segment dimensions mm	Number of segments	Maximum speed /min	Sales unit	Packaging	Order no.
 <p>Diamond cutting discs "professional" / CP</p> <ul style="list-style-type: none"> Powerful diamond cutting disc with segmented edge for aggressive, fast cutting of hard materials with very high cutting performance and very good tool life Particularly suited for all hard materials such as concrete (including reinforced), concrete pipes, kerbstones, hard sandstone, facing stones, exposed aggregate concrete thanks to special turbo segments Highest safety thanks to laser-welded diamond segments. Segment height 12 mm. <p>NEW</p>	115 x 22,23	33 x 2,4 x 12	8	13.300	1	Cardboard box	628570000*
	125 x 22,23	33 x 2,4 x 12	9	12.200	1	Cardboard box	628571000*
	150 x 22,23	33 x 2,4 x 12	10	10.200	1	Cardboard box	628572000*
	180 x 22,23	42 x 2,6 x 12	11	8.500	1	Cardboard box	628573000*
	230 x 22,23	42 x 2,6 x 12	15	6.600	1	Cardboard box	628574000*

For granite; segmented

	Diameter x bore mm	Segment dimensions mm	Number of segments	Maximum speed /min	Sales unit	Packaging	Order no.
 <p>Diamond cutting discs "professional" / GP</p> <ul style="list-style-type: none"> Powerful diamond cutting disc with segmented edge for aggressive, fast cutting of hard materials with high cutting performance and very good tool life Particularly suited for all types of granite, patio slabs Highest safety thanks to laser-welded diamond segments. Segment height 12 mm. <p>NEW</p>	115 x 22,23	20 x 2,4 x 12	13	13.300	1	Cardboard box	628575000*
	125 x 22,23	20 x 2,4 x 12	15	12.200	1	Cardboard box	628576000*
	230 x 22,23	20 x 2,6 x 12	30	6.600	1	Cardboard box	628577000*

For tiles; enclosed edge

	Diameter x bore mm	Segment dimensions mm	Number of segments	Maximum speed /min	Sales unit	Packaging	Order no.
 <p>Diamond cutting discs "SP" / SP-T</p> <ul style="list-style-type: none"> Standard diamond cutting disc with closed edge for cutting without chipped edges on workpieces with high-quality surfaces such as tiles, natural stone slabs High cutting output and good tool life Segment height 7 mm Delivery in counter display when ordering 10 pieces <p>NEW</p> 	115 x 22,23	1,5 x 7		13.300	1	Cardboard box	628555000*
	125 x 22,23	1,5 x 7		12.200	1	Cardboard box	628556000*
	230 x 22,23	1,65 x 7		6.600	1	Cardboard box	628557000*

	Diameter x bore mm	Segment dimensions mm	Number of segments	Maximum speed /min	Sales unit	Packaging	Order no.
 <p>Diamond cutting discs "professional" / TP</p> <ul style="list-style-type: none"> Powerful diamond cutting disc with closed edge for cutting without chipped edges on workpieces with high-quality surfaces with high cutting performance and very good tool life Fast and clean cutting results thanks to extra thin steel blade with steel core reinforcement and particular cutting edge geometry Particularly suited for: fine earthenware, tiles, natural stone slabs Segment height 10 mm <p>NEW</p>	115 x 22,23	1,4 x 10		13.300	1	Cardboard box	628578000*
	125 x 22,23	1,4 x 10		12.200	1	Cardboard box	628579000*
	230 x 22,23	1,6 x 10		6.600	1	Cardboard box	628580000*
 <p>Diamond cutting discs "professional" 76 mm / TP</p> <ul style="list-style-type: none"> Special disc to meet the highest demands for all types of tiles, glazed and unglazed, natural stone slabs, fine earthenware, ceramic Optimum cutting quality and very long tool life thanks to optimised thin wall technology and adapted diamond structure Sintered cutting edge, segment height: 6 mm <p>NEW</p>	76 x 10	1 x 6		20.100	1	Blister	626874000*

Universal, segmented

	Diameter x bore mm	Segment dimensions mm	Number of segments	Maximum speed /min	Sales unit	Packaging	Order no.
 <p>Diamond cutting discs "professional" 76 mm / UP</p> <ul style="list-style-type: none"> Diamond cutting disc with vacuum-soldered diamonds for universal application Very good cutting properties due to a high diamond content Suitable for a variety of materials, such as concrete, tiles, composite materials, gypsum plaster, PVC, sheet metal, threaded rods, thin wood <p>NEW</p>	76 x 10	12 x 1,2 x 2,2	16	20.100	1	Blister	626873000*

Diamond channelling discs

Quality class "professional" / UP-T

- Fast and comfortable cutting of wall slots in different materials possible
- Highly reduced workload thanks to the intelligent system of interlacing arrangement of segments, since cutting away of the centre is not required. Great time saving thanks to cutting in one step
- Reduction of dirt and dust, since the material is removed cleanly and completely from the slot
- Customised slots for individual lines, or for Ø 20 and 25 mm-empty pipes. Max. cutting width: 20 mm (2 rows 628298000) / 30 mm (3 rows 628299000)

	Diameter x bore mm	Segment dimensions mm	Number of segments	Maximum speed /min	Sales unit	Packaging	Order no.
	125 x 22,23	18 x 7	20	12.200	1	Cardboard box	628298000*
	125 x 22,23	28,5 x 7	30	12.200	1	Cardboard box	628299000*



Diamond and PCD cup wheels

High-grade and robust diamond and PCD cup wheels from Metabo provide maximum grinding comfort and can be used in a particularly economical manner for different applications. They combine maximum material removal with long tool life. This results in a particularly effective processing of different materials, such as concrete, screed, lime/cement plaster, tile adhesive, protective coatings.

Diamond and PCD cup wheels are available in two quality classes:

Classic:

- Good service life
- Good material removal



Professional:

- Longest tool life
- Very good material removal



Recommended use:

- The Metabo renovation grinders in connection with a suitable vacuum cleaner permit particularly low-dust working
- We recommend the use of appropriate extraction shrouds when working with angle grinders

For abrasive materials, quality class abrasive "professional"



- Particularly powerful diamond cup wheel
- Excellently suited for grinding of fresh concrete coatings, chalk and cement plaster, gypsum filler, levelling of fresh screed, removal of tile adhesive and processing of marble
- Maximum working speed 80 m/s

Diameter x bore mm	Number of segments	Maximum speed	Sales unit	Order no.
125 x 22,23	16	12.200	1	628206000*

For protective concrete coatings, quality class "professional"



- Particularly powerful PCD special cup wheel
- Excellently suited for spot grinding and removal of elastic protective coatings, adhesives, sealants, removal of latex and oil paints, bitumen, PU/polyurethane, epoxy, elastic adhesive, for removal of lime plaster and gypsum plaster, sanding of resin plaster and hard cement plaster.
- Fast and effective removal without sticking due to PCD (poly-crystalline diamonds) segments
- Maximum working speed 80 m/s

Diameter x bore mm	Number of segments	Maximum speed	Sales unit	Order no.
125 x 22,23	12	12.200	1	628208000*
150 x 22,23	15	10.200	1	NEW 628097000*

Diamond cup wheels

For hard materials, quality class concrete "classic"



- Powerful, double coated diamond cup wheel
- Well suited for grinding of thick concrete layers, levelling of concrete and granite and other natural stones, removal of sludge skins and formwork seams on concrete, removal of hard cement, chalk-cement-plaster, hard screed
- Maximum working speed 80 m/s

Diameter x bore mm	Number of segments	Maximum speed	Sales unit	Order no.
125 x 22,23	20	12.200	1	628209000*

For hard materials, quality class concrete "professional"



- Particularly powerful diamond cup wheel
- Well suited for grinding of thick concrete layers, levelling of concrete and granite and other natural stones, removal of sludge skins and formwork seams on concrete, removal of hard cement, chalk-cement-plaster, hard screed
- Precise processing of edges without cracking
- Maximum working speed 80 m/s

Diameter x bore mm	Number of segments	Maximum speed	Sales unit	Order no.
125 x 22,23	16	12.200	1	628205000*

* Self-service packaging

01
02
03
04
05
06
07
08
09
10
11
12
13
14
15
16



Diamond core bits for tiles "Dry"

These high-grade diamond core bits (M14) for dry use with angle grinders are characterised by a long service life and fast drilling progress thanks to vacuum hard-soldered diamonds. In connection with an adapter from M14 to hexagon (order no. 630859000), the diamond core bits can also be used with drills and impact drills. They permit efficient processing of different materials, such as fine earthenware, tiles and granite.

Benefits:

- Long service life and fast drilling progress
- Easy removal of the drill core thanks to lateral recesses
- No extra cooling required. For Ø 6-14 mm an additional paraffin emulsion is integrated for improved cooling.
- The diamond core bits "Dry" are available individually and in practical sets

Recommended use:

- Recommended useful length = material thickness of the tile, fine earthenware etc. in general max. 2 cm
- Recommended useful length for granite and worktops up to 5 cm
- Repeated pulling out of the core bit from the bore for cooling
- Maximum working speed 80 m/s



Diamond tools "Dry"

Diamond drill bits for tiles "Dry", M14



- M14 Thread for use on angle grinders
- Long service life and fast drilling progress thanks to vacuum hard soldered diamonds
- Easy removal of the drill core thanks to lateral recesses
- No extra cooling required. For Ø 6-14 mm an additional paraffin emulsion is integrated for improved cooling. We recommend to briefly cool the tip with water in case of drilling in quick succession!
- We recommend using the thickness of the tile / fine earthenware / granite board as useful length. As a rule, max. 2 cm granite boards / work boards up to 5 cm can be drilled. Retract the drill bit often from the drilled hole so that it can cool down!
- Important: Do not drill into the subsurface in case of laid material!
- Maximum working speed: 80 m/s

Diameter mm	Overall length mm	Sales unit	Order no.
6	64	1	628300000*
8	64	1	628301000*
10	64	1	628302000*
12	64	1	628303000*
14	64	1	628304000*
18	91	1	628305000*
20	91	1	628306000*
25	91	1	628307000*
32	91	1	628308000*
35	91	1	628309000*
40	91	1	628310000*
45	91	1	628318000*
50	91	1	628311000*
55	91	1	628312000*
60	91	1	628313000*
68	91	1	628314000*
75	91	1	628315000*
82	91	1	628316000*

Diamond drill bit set for tiles "Dry", M14

- M14 Thread for use on angle grinders
- Long service life and fast drilling progress thanks to vacuum hard soldered diamonds
- Easy removal of the drill core thanks to lateral recesses
- No extra cooling required. For Ø 6-14 mm an additional paraffin emulsion is integrated for improved cooling. We recommend to briefly cool the tip with water in case of drilling in quick succession!
- We recommend using the thickness of the tile / fine earthenware / granite board as useful length. As a rule, max. 2 cm granite boards / work boards up to 5 cm can be drilled. Retract the drill bit often from the drilled hole so that it can cool down!
- Important: Do not drill into the subsurface in case of laid material!
- Maximum working speed: 80 m/s



NEW

Diamond drill bit set for tiles "Dry" 7 pieces
Set consisting of: 2 each Ø 6 mm, 2 x 8 mm, 1 each 10 mm, 12 mm, 14 mm

Order no.

628321000



Diamond drill bit set for tiles "Dry" , 3 pieces
Set consisting of: 1 each Ø 35 mm, 50 mm, 68 mm;

628322000



NEW

Diamond drill bit set for tiles "Dry" 4 pieces
Set consisting of: 1 each Ø 35 mm, 40 mm, 50 mm, 68 mm

628319000



Diamond drill bit set for tiles "Dry" 7 pieces
Set consisting of: each 1 x Ø 6 mm, 8 mm, 14 mm, 35 mm, 40 mm, 50 mm, 68 mm;

628317000



NEW

Diamond drill bit set for tiles "Dry" 6 pieces
Set consists of: 1 each Ø 35 mm, 40 mm, 50 mm, 68 mm + diamond core bit 20 mm + diamond cup wheel 50 mm

628320000

Adapter for diamond core bits "Dry"



Adapter hexagon 10 mm / M 14
■ For the use of diamond core bits "Dry" for drills and impact drills
Receptacle: hexagonal 10mm, M 14 male thread

Order no.

630859000*

Diamond core bit "Dry", M14



NEW

Diamond milling cutter 20 mm "Dry"
■ Diamond milling cutter Ø 20 mm for routing, chamfering, drilling and widening
■ Useable length: 40 mm; overall length: 75 mm
■ Connection M14 for use with angle grinder Ø 115 + 125 mm
■ Maximum working speed: 80 m/s

Order no.

628327000*

Diamond cup wheel "Dry", M14



NEW



Diamond cup wheel 50mm "Dry"
■ Powerful diamond cup wheel with turbo segments Ø 50 mm/ M14 female thread
■ Ideally suited for repair works and clean processing of edges without chipping
■ Extremely powerful also for smaller modelling work
■ Connection M14 for use with angle grinder Ø 115 + 125 mm
■ Maximum working speed: 80 m/s

Order no.



628328000*

* Self-service packaging

Grinding wheels

	Quality class	Diameter x thickness x bore mm	Version	Maximum speed /min	Sales unit / packing unit	Order no.
	Quality class A 46-U "Flexiarapid Super" Inox <ul style="list-style-type: none"> The super-thin high-output disc especially for processing stainless steel Super quick with very long service life thanks to the use of special corundums Low in iron, sulphur and chlorine (Fe + S + Cl ≤ 0.1 %) For all rust and acid resistant steels (V2A, Niosta, INOX), spring steels, tool steels For use in the manufacture of vehicles, containers, car bodies, consumer units etc. Cutting discs for quiet, precise cutting, cuts without burrs Hardness: hard Maximum working speed 80 m/s 	76 x 1 x 10	—	20.100	5/1	626870000*
	Quality class A 46-U "Combinator" Inox HydroResist <ul style="list-style-type: none"> One grinding wheel for two applications: quick cutting, and easy deburring and sanding All-purpose use for processing stainless steel and for general metal processing Low in iron, sulphur and chlorine (Fe + S + Cl ≤ 0.1 %) Hardness: hard Reduces labour costs by saving on set-up time Eliminates time-consuming disc change during mobile use. Highest standards in quality and safety thanks to the dimensional and lateral stability of the disc design (proven safety with 3 full-surface layers of material) Maximum working speed: 80 m/s 	76 x 2 x 10	⌒	20.100	3/1	626872000*
	Quality class C 30-S "Flexiarapid Super" Universal <ul style="list-style-type: none"> Super thin special disc for processing tiles, ceramic, clinker etc. Universal use Very high cutting output with above average tool life Quick cutting time, less cutting wastage, cleaner cutting edges Maximum working speed 80 m/s 	76 x 1 x 10	—	20.100	5/1	626871000*

Diamond cutting discs

	Diameter x bore mm	Segment dimensions mm	Number of segments	Maximum speed /min	Sales unit	Packaging	Order no.
	76 x 10	1 x 6		20.100	1	Blister	626874000*
	76 x 10	12 x 1,2 x 2,2	16	20.100	1	Blister	626873000*

Set

	Order no.
 Starter set Ø 76 mm <ul style="list-style-type: none"> Three-part accessory set for numerous applications with the PowerMaxx CC 12 BL and CC 18 LTX BL cordless angle grinders with a 76 mm disc diameter Starter set consisting of: Cutting disc Flexiarapid Super Inox Ø 76x1.0x10 mm, cutting/grinding disc Combinator Ø 76x2.5x10 mm, diamond cutting disc Universal professional Ø 76x10 mm Diameter: 76 mm 	626879000*

Flap disc

	Diameter x bore mm	Grit	Version	Maximum speed /min	Sales unit / packing unit	Order no.
						
Quality class zirconia alumina "Flexiamant" <ul style="list-style-type: none"> Suitable for rough and intermediate grinding in all fields of metalworking including stainless steel, steel, cast iron, and sheet steel High lamellar lining on fibreglass plate Uniform grinding capacity Cool grinding Low noise level Uniform grinding result, comfortable grinding with only low vibration Most suitable for processing stainless steels Maximum working speed 80 m/s; tilted version: angle of attack 7-9° 						
	76 x 10	P 60	⌒	20.100	1/1	626875000*
	76 x 10	P 80	⌒	20.100	1/1	626876000*







* Self-service packaging







Which system accessories are suitable for which angle grinder?







Model	Order no.	Cut-off clip guard	Extraction shroud clip CED 125 Order no. 630401000	Cutting dust extraction shroud CED 125 Order no. 626730000	Cutting dust extraction shroud CED 125 Plus, Order no. 626731000	Grinding dust extraction shroud GED 125 Order no. 626732000	Guard for cup wheel Ø 80 mm Order no. 623276000	Metabo VibraTech (MVT) side handle	Bow-type handle # Order no. 623262000	Multi-position handle for side handle Order no. 627362000	Dust protection filter (example illustration)	Metabo "Quick" flange nut M 14 Order no. 630802000	Quick-locking nut M 14 Order no. 630832000	Flange nut M 14 Order no. 630706000
W 750-100	603603	630346000						627361000						
W 850-100	603606	630346000						627361000						
W 9-100	600350	630346000						627361000			630835000			
W 750-115	603604	630351000						627361000						
W 850-115	603607	630351000						627361000						
W 9-115	600354	630351000						627361000			630835000			
W 9-115 Quick	600371	630351000						627361000			630835000			
WP 9-115 Quick	600380	630351000						627361000						
W 1100-115	603613	630351000						627361000						
WP 1100-115	603612	630351000						627361000						
WP 11-115 Quick	603621	630351000						627361000						
W 750-125	603605	630352000						627361000						
W 850-125	603608	630352000						627361000						
WP 850-125	603610	630352000						627361000						
WEV 850-125	603611	630352000						627361000						
W 9-125	600376	630352000						627361000			630835000			
W 9-125 Quick	600374	630352000						627361000			630835000			
WP 9-125 Quick	600384	630352000						627361000						
WQ 1100-125	610035	630352000						627361000						
W 1100-125	603614	630352000						627361000						
W 11-125	603622	630352000						627361000			630835000			
W 11-125 Quick	603623	630352000						627361000			630835000			
WP 11-125 Quick	603624	630352000						627361000						
WEV 11-125 Quick	603625	630352000						627361000			630835000			
WEA 11-125 Quick	603626	630352000						627361000			630835000			
W 13-125 Quick	603627	630352000						627361000			630709000			
WP 13-125 Quick	603629	630352000						627361000			630792000			
WA 13-125 Quick	603630	630352000						627361000			630709000			
WPB 13-125 Quick	603631	630352000						627361000			630792000			
WPB 13-125 Quick DS	600437	630352000						627361000			630792000			
WE 15-125 Quick	600448	630352000						627361000			630709000			
WEP 15-125 Quick	600476	630352000						627361000			630792000			
WEA 15-125 Quick	600492	630352000						627361000			630709000			
WEV 15-125 Quick	600468	630352000						627361000			630709000			
WEVA 15-125 Quick	600496	630352000						627361000			630709000			
WEV 15-125 Quick HT	600562	630352000						627361000			630709000			
WE 17-125 Quick	600515	630352000						627361000			630709000			
WEP 17-125 Quick	600547	630352000						627361000			630792000			
WEV 17-125 Quick	600516	630352000						627361000			630709000			
WEV 17-125 Quick Inox	600517	630352000						627361000			630709000			
WEA 17-125 Quick	600534	630352000						627361000			630709000			

Model	Order no.	Cut-off clip guard (for Ø 180 mm; cutting blade guard, semi-enclosed)	Extraction shroud clip CED 125 Order no. 630401000	Cutting dust extraction shroud CED 125 Order no. 626730000	Cutting dust extraction shroud CED 125 Plus Order no. 626731000	Grinding dust extraction shroud GED 125 Order no. 626732000	Guard for cup wheel Ø 80 mm Order no. 623276000	Metabo VibraTech (MVT) side handle	Bow-type handle Order no. 623262000	Multi-position handle for side handle Order no. 627362000	Dust protection filter (example illustration)	Metabo "Quick" flange nut M 14 Order no. 630802000	Quick-locking nut M 14 Order no. 630832000	Flange nut M 14 Order no. 630706000
WEBA 17-125 Quick	600514	630352000						627361000			630709000			
WEPBA 17-125 Quick	600548	630352000						627361000			630792000			
WEPBA 17-125 Quick DS	600549	630352000						627361000			630792000			
WEQ 1400-125	600347	630352000						627361000						
W 13-150 Quick	603632	630353000						627361000			630709000			
WP 13-150 Quick	603633	630353000						627361000			630792000			
WPB 13-150 Quick DS	603645	630353000						627361000			630792000			
WE 15-150 Quick	600464	630353000						627361000			630709000			
WEP 15-150 Quick	600488	630353000						627361000			630792000			
WEV 15-150 Quick HT	600563	630353000						627361000			630709000			
WE 17-150 Quick	601074	630353000						627361000			630709000			
WEP 17-150 Quick	600507	630353000						627361000			630792000			
WEV 17-150 Quick	600473	630353000						627361000			630709000			
WEA 17-150 Quick	600535	630353000						627361000			630709000			
WEPBA 17-150 Quick	600552	630353000						627361000			630792000			
WEPBA 17-150 Quick DS	600553	630353000						627361000			630792000			
WP 1200-125 RT	601240	630352000						627361000						
WEV 1500-125 RT	601243	630352000						627361000						
WE 1500-125 RT	601241	630352000						627361000						
WEPBA 17-125 Quick RT DS	600605	630352000						627361000			630719000			
WEPBA 17-125 Quick RT	601097	630352000						627361000			630719000			
WEV 17-125 Quick Inox RT	601092	630352000						627361000			630719000			
WEV 17-125 Quick RT	601089	630352000						627361000			630719000			
WE 17-125 Quick RT	601086	630352000						627361000			630719000			
WE 1500-150 RT	601242	630353000						627361000						
WEP 1500-150 RT	601244	630353000						627361000						
WEPBA 17-150 Quick RT DS	600606	630353000						627361000			630719000			
WEPBA 17-150 Quick RT	601098	630353000						627361000			630719000			
WEP 17-150 Quick RT	601078	630353000						627361000			630719000			
WE 17-150 Quick RT	601087	630353000						627361000			630719000			
WEPB 19-180 RT DS	601096	630383000						627361000			630719000			
WEPBA 19-180 Quick RT	601099	630383000						627361000			630719000			
WEA 19-180 Quick RT	601095	630383000						627361000			630719000			
WE 19-180 Quick RT	601088	630383000						627361000			630719000			

Which system accessories are suitable for which angle grinder?

Model	Order no.	 Bench cut-off stand Order no. 635000000	 Cutting blade guard, semi-enclosed Order no. 630356000	 Cutting dust extraction shroud CED 230 Order no. 626752000	 Guard for cup wheel Ø 110 mm Order no. 623140000	 Metabo Vibra Tech (MVT) side handle Order no. 627360000	 "Quick" flange nut M 14 Order no. 630800000	 Flange nut M 14 Order no. 630706000
W 2000-180	606429		630356000					
W 22-180 MVT	606461		630356000					
W 2200-180	606434		630356000					
WP 2200-180	606438		630356000					
WE 22-180 MVT	606463		630356000					
W 24-180 MVT	606466		630356000					
WE 24-180 MVT	606468		630356000					
WEA 24-180 MVT Quick	606471		630356000					
W 26-180 MVT	606473		630356000					
WEPB 24-180 MVT	606478		630356000					
WEPBA 24-180 MVT Quick	606480		630356000					
W 2000-230	606430	■	630357000	■	■	■	■	■
WP 2000-230	606431	■	630357000	■	■	■	■	■
WE 2000-230	606432	■	630357000	■	■	■	■	■
W 2200-230	606435	■	630357000	■	■	■	■	■
WP 2200-230	606436	■	630357000	■	■	■	■	■
WE 2200-230	606437	■	630357000	■	■	■	■	■
WEP 2200-230	606428	■	630357000	■	■	■	■	■
WE 2400-230	606484	■	630357000	■	■	■	■	■
WEP 2400-230	606439	■	630357000	■	■	■	■	■
W 22-230 MVT	606462	■	630357000	■	■	■	■	■
WE 22-230 MVT	606464	■	630357000	■	■	■	■	■
WE 22-230 MVT Quick	606465	■	630357000	■	■	■	■	■
W 24-230 MVT	606467	■	630357000	■	■	■	■	■
WE 24-230 MVT	606469	■	630357000	■	■	■	■	■
WE 24-230 MVT Quick	606470	■	630357000	■	■	■	■	■
WEA 24-230 MVT Quick	606472	■	630357000	■	■	■	■	■
W 26-230 MVT	606474	■	630357000	■	■	■	■	■
WE 26-230 MVT Quick	606475	■	630357000	■	■	■	■	■
WEA 26-230 MVT Quick	606476	■	630357000	■	■	■	■	■
WEPB 24-230 MVT	606479	■	630357000	■	■	■	■	■
WEPBA 24-230 MVT Quick	606481	■	630357000	■	■	■	■	■
WEPBA 26-230 MVT Quick	606482	■	630357000	■	■	■	■	■

Model	Order no.	 Cut-off clip guard	 Cutting blade guard, semi-enclosed	 Dust extraction shroud clip CED 125 Order no. 630401000	 Metabo Vibra Tech (MVT) side handle	 Quick-locking nut M 14 Order no. 630832000	 Flange nut M 14 Order no. 630706000
W 18 LTX 115	602170	630351000			627361000	■	■
WPB 18 LTX BL 115	613074	630351000			627361000	■	■
W 18 LTX 125	600165	630352000		■	627361000	■	■
W 18 LTX 125 Quick	602174	630352000		■	627361000	■	■
WP 18 LTX 125 Quick	613072	630352000		■	627361000	■	■
WB 18 LTX BL 125 Quick	613077	630352000		■	627361000	■	■
WB 18 LTX BL 125 Q SE	613090	630352000		■	627361000	■	■
WPB 18 LTX BL 125 Quick	613075	630352000		■	627361000	■	■
W 18 LTX 125 Quick Inox	600174	630352000		■	627361000	■	■
W 18 LTX 150	600404	630353000			627361000	■	■
WB 18 LTX BL 150 Quick	613078	630353000			627361000	■	■
WPB 18 LTX BL 150	613076	630353000			627361000	■	■
WB 18 LTX BL 180	613087		630390000		627361000		■
WPB 36 LTX BL 230	613101		630363000		627360000		■
WPB 36-18 LTX BL 230	613102		630363000		627360000		■

Model	Order no.	 Cut-off clip guard	 Metabo Vibra Tech (MVT) side handle Order no. 627361000	 Bow-type handle Order no. 623262000	 Multi-position handle for side handle Order no. 627362000	 Dust protection filter (example illustration)	 Quick-locking nut M 14 Order no. 630832000	 Flange nut M 14 Order no. 630706000
WEF 9-125 Quick	613060	630355000	■				■	■
WEPF 9-125 Quick	613069	630355000	■				■	■
WEVF 10-125 Quick Inox	613080	630372000	■	■	■		■	■
WEF 15-125 Quick	613082	630372000	■	■	■	630709000	■	■
WEF 15-150 Quick	613083	630378000	■	■	■	630709000	■	■
WEPBF 15-150 Quick	613084	630378000	■	■	■	630792000	■	■
WEPF 15-150 Quick	613085	630378000	■	■	■	630792000	■	■
WF 18 LTX 125	601306	630355000	■				■	■
WPF 18 LTX 125	613070	630355000	■				■	■

01
02
03
04
05
06
07
08
09
10
11
12
13
14
15
16

Cutting systems: For low-dust working.

The cutting systems using angle grinders bring high performance with low-dust processing of concrete, screed or tiles. With optimally harmonised systems of machines, extraction shrouds, special discs and matching vacuum cleaner you can work with high productivity, whilst your working environment remains almost free of dust and your health is protected.



CED 125 Plus
Order no. 626731000

CED 125
Order no. 626730000

Guide rail
Order no. 631213000

Diamond cutting discs Ø 125 mm



Universal »professional« / UP
Order no. 628559000



Concrete »professional« / CP
Order no. 628571000



Granite »professional« / GP
Order no. 628576000



Tiles »professional« / TP
Order no. 628579000

Diamond cutting discs Ø 230 mm



Universal »professional« / UP
Order no. 628562000



Concrete »professional« / CP
Order no. 628574000



Granite »professional« / GP
Order no. 628577000



Tiles »professional« / TP
Order no. 628580000



CED 230
Order no. 626752000



*You can find the suitable types in the system overview at the beginning of this chapter.



PE disposal bag
Order no. 630325000



All-purpose vacuum cleaners
ASR 35 L ACP
Order no. 602057

ASR 35 M ACP
Order no. 602058

ASR 35 H ACP
Order no. 602059



Anti-static suction hose Ø 35 mm
Order no. 631370000



Polyester filter cassettes
Order no. 631034000

Bench cut-off stand



Bench cut-off stand

- Suitable for all Metabo angle grinders with cutting disc-Ø 230 mm, except for cordless angle grinder
 - For secure fixed use of the angle grinder as a cutting machine: mitre setting 0-45°
 - Largest cutting depth when using an angle grinder with 230mm cutting wheel = 50 mm; maximum span width = 100 mm
 - Dimensions of table top: 244 x 321 mm; table height: 34.5 mm
 - Scope of delivery: length guide, 6mm Allen key
- Weight: 9.7 kg

Order no.

635000000

Guards



Cutting blade guard

- For working with fibre-reinforced, resin-bonded cutting discs
 - EN/EC 60745
- For working with hubbed wheels, diameter: 6"/ 150 mm

Order no.

630412000

NEW

Cutting guard clip



- For working with fibre-reinforced, resin-bonded cutting discs
- The cut-off clip guard is simply attached to the existing guard of the angle grinder
- EN/EC 60745
- Material: plastic
- Suitable for Metabo angle grinders: W..8-..; W..9-..; W..10-..; W..11-..; W..12-..; W..13-..; W..14-..; W..15-..; W..17-..; W 18 LTX; made in 2008 onwards

Grinding wheel Ø mm

115

125

150

Order no.

630351000

630352000

630353000

Extraction guard clip for cutting



Extraction shroud clip

- Extraction guard clip for angle grinders with Ø 125 mm for low-dust dry cuts up to 30 mm in mineral materials
- Efficient dust extraction for health protection and clean construction sites. Antistatic material prevents electric charge and dust accumulation
- Best view on the cutting position thanks to the open design of the dust extraction shroud
- Fast, tool-free fitting on the guard of the angle grinder
- Connection for dust extraction Ø 35/ 41 mm
- Suitable for Metabo W...750-125; W...850-125; W...8-125; W...9-125; W...10-125; W...11-125; W...12-125; W...13-125; W...14-125; W...15-125; W...17-125; W 18 LTX 125; WB 18 LTX BL 125; WP 18 LTX 125; WPB 18 LTX BL 125 (made in 2008 onwards)

Order no.

630401000*

NEW



Almost dust-free working from mineral dust

- CED 230 for low-dust dry cuts up to 60 mm
- CED 125 / CED 125 Plus: For low-dust dry cuts up to 25 mm, freehand cuts up to 27 mm

Precise longitudinal cuts with the CED 125 Plus

- Guide rollers for precise directional stability
- Adjustable cutting depth
- Optional use of a guide rail for precise cut

CED 125 / CED 125 Plus:

- Ideal for free-hand cuts
- Tool-free, quick removal of the base plate
- Perfect for the renovation of cracks

* Self-service packaging

Abrasive cutting blade guards, semi-enclosed, with quick adjustment



- For working with fibre-reinforced, resin-bonded cutting discs
- EN/EC 60745

Grinding wheel Ø mm	Suitable for	Order no.
180	Metabo angle grinder Ø 180 mm (with clamping lever at the flange)	630370000
230	Metabo angle grinder Ø 230 mm (with clamping lever at the flange)	630371000
180	Metabo angle grinder Ø 180 mm (with clamping lever at the guard)	630356000
230	Metabo angle grinder Ø 230 mm (with clamping lever at the guard)	630357000
125	WEF 9-125 / WF 18 LTX 125, WEPF 9-125 Quick / WPF 18 LTX 125	630355000
125	WEF 15-125 Quick, WEVF 10-125 Quick Inox	630372000
150	WEF 15-150 Quick, WEPF 15-150 Quick, WEPBF 15-150 Quick	630378000
180	Metabo angle grinder WE...180...RT	630383000
180	W 17-180 / WX 17-180	630388000
180	WB 18 LTX 180 Quick	630390000
230	Metabo cordless angle grinder Ø 230 mm	630363000

Cutting blade guard, semi enclosed, with clamping screw



- For working with fibre-reinforced, resin-bonded cutting discs
- EN/EC 60745

Grinding wheel Ø mm	Suitable for	Order no.
115	W 6-115	630814000
125	W 1080-125	630364000
150	WE 1450-150 RT	630362000
180	W 2000 / WX 2000	630386000
230	W 2000 / WX 2000	630387000

Cutting blade guards with cutting guides



Dust extraction shroud CED 125

- Dust extraction shroud with plunge function and optimised flow channel for particularly low-dust cutting both indoors and outdoors
- Compact design and tool-free removable table for more flexibility when working close to the wall, as well as improved visibility for freehand cuts
- Tool-free adjustable cutting depth
- Robust sheet metal table for tilt-proof operation
- Anti-static plastic prevents electric charging and dust accumulations for a constantly high suction power
- Large, coloured operating elements for simple, tool-free adjustment, even when wearing gloves
- Connection for dust extraction Ø 35/41 mm
- Max. cutting depth for freehand cuts is 27 mm, with table 25 mm
- Suitable for: W..9-125; WEV 10-125 Quick; W..12-1.; W..13-1.; WE..115-1.; WE..17-1.; W..8-1.; WE 9-125 Quick; W..11-1.; WQ 1400 (only 600346000); WE 14-1.(from year of manufacture 2009); WQ 1100 und WEQ 1400; Not suitable for angle grinder with Auto-balancer; scope of delivery incl. nut with two holes 5/8" and M14.

Cutting disc-Ø: 115/125 mm
Maximum cutting depth: 27 mm

Order no.
626730000



Cutting dust extraction shroud CED 125 Plus

- Dust extraction shroud with plunge function and optimised flow channel for particularly low-dust cutting both indoors and outdoors
- Compact design and tool-free removable table for more flexibility when working close to the wall, as well as improved visibility for freehand cuts
- Cutting depth can be adjusted without tools. Max. cutting depth for freehand cuts is 27 mm, with table 25 mm, with precision guide rail 20 mm
- Robust sheet metal table for tilt-proof operation. Connection for dust extraction Ø 35/41 mm
- Anti-static plastic prevents electric charging and dust accumulations for a constantly high suction power
- Large, coloured operating elements for simple, tool-free adjustment, even when wearing gloves
- Sheet metal table with guide rollers for easy, precise feed. Protect delicate surfaces from scratches.
- Enables the use of a Metabo precision guide rail for cuts with great precision
- Suitable for: W..9-125; WEV 10-125 Quick; W..12-1.; W..13-1.; WE..115-1.; WE..17-1.; W..8-1.; WE 9-125 Quick; W..11-1.; WQ 1400 (only 600346000); WE 14-1.(from year of manufacture 2009); WQ 1100 und WEQ 1400; Not suitable for angle grinder with Auto-balancer; scope of delivery incl. nut with two holes 5/8" and M14.

Cutting disc-Ø: 115/125 mm
Maximum cutting depth: 27 mm

Order no.
626731000



NEW

Cutting dust extraction shroud CED 230

- Cutting dust extraction shroud for angle grinders with Ø 230 mm for low-dust dry cuts up to 60 mm in mineral materials
- Best view on the cutting line thanks to the open design of the dust extraction shroud
- Efficient dust extraction for health protection and clean construction sites
- Precise cuts on even surfaces thanks to metal base plate with rollers
- Robust die-cast aluminium dust extraction shroud with tool-free setting of the cutting depth
- Connection for dust extraction Ø 35/41 mm
- Compatible with W...-230 MVT; T...-230 MVT

Cutting disc-Ø: 230 mm
Maximum cutting depth: 60 mm

Order no.
626752000

Guard tuckpointing



NEW

Guard "Tuckpointing" 125 mm

- Robust dust extraction guard for quick removal of mortar joints. Optimal view of the working area for precise working. Cleaning flap for quick, tool-free access for disc change. Extraction tube as additional handle for comfortable handling. Connection for the dust extraction Ø 2 1/4" (58 mm)

Suitable for W..12-1.; WE..15-1.; WE..17-1..

Order no.
628216000

Cup wheel guards with accessories



Grinding dust extraction shroud GED 125

- Quick, tool-free installation of the extraction shroud on a compatible angle grinder
- Integrated sliding segment for quick, tool-free access even when wearing gloves, for working close to walls.
- Extraction shroud with flexible brush rim and optimised extraction channel for particularly low-dust grinding indoors and outdoors
- Anti-static plastic prevents electric charges and dust accumulations ensuring constantly high suction power. Connection for dust extraction Ø 35/41 mm
- Suitable for angle grinder with disc-Ø 125 mm: W..9-1.; WEV 10-125 Quick; W..12-1.; W..13-1.; WE..15-1.; WE..17-1.; W..8-1.; WE 9-125 Quick; W..11-1.; WQ 1400 (only 600346); WE 14-1.; not suitable for WP 1200-125 RT, WEV 1500-125 RT, WE 1500-125 RT



Order no.
626732000







Replacement brush rim GED 125

- Replacement brush rim for replacement on the dust extraction shroud GED 125

Order no.
626733000

	Order no.
 <p>Cup wheel guard Ø 80 mm</p> <ul style="list-style-type: none"> ■ For angle grinder with collar diameter 50 mm and grinding wheel-Ø 115 mm, 125 mm and 150 mm for the use of ceramic cup wheels Ø 80 mm ■ For angle grinders with tool-free guard adjustment the clamping lever must be removed. Please pay attention to operating instructions! ■ Adjustable 	623276000
 <p>Cup wheel guard Ø 110 mm</p> <ul style="list-style-type: none"> ■ For angle grinders with grinding wheel Ø of 180 and 230 mm for use of ceramic cup wheels Ø 110 mm ■ Adjustable 	623140000







Support handles for angle grinders

	Order no.
 <p>Metabo VibraTech (MVT) side handle, M 14</p> <ul style="list-style-type: none"> ■ Suitable for all angle grinders with M 14 thread 	627360000*
 <p>Metabo VibraTech (MVT) side handle, M 8</p> <ul style="list-style-type: none"> ■ Suitable for Metabo angle grinders with M 8 thread 	627361000*
 <p>Front handle WS</p> <ul style="list-style-type: none"> ■ Front handle with ideal ergonomics, e.g. for surface grinding with fibre discs, light polishing work with diamond cup wheels etc. ■ Suitable for Metabo angle grinders W..9..; W..11..; WE 10..; W..12..; W..13..; WE 15..; WE 17.. ■ Not suitable for: WP 1200-125 RT, WEV 1500-125 RT, WE 1500-125 RT, WE 1500-150 RT 	623262000
 <p>Multi-positioning for side handle</p> <ul style="list-style-type: none"> ■ The 180° handle permits variable individual adjustment of the side handle position for ergonomic, low-fatigue working e.g. for cutting jobs or for left-handed users ■ The side handle can be adjusted without tools for changing working positions ■ The robust hexagon shape permits folding the side handle to the rear for safe, two-handed operation in confined spaces ■ Suitable for W..9-1..; W..11-1..; W..12-1..; W..13-1..; WE15-1..; WE..17-1..; W..8-1..; WE9-125; W..11-1..; WEQ 1400-125; WE14-1..; WEVF 10-1..; WE..F 15-1..; WE..19-180.. ■ Not suitable for: WP 1200-125 RT, WEV 1500-125 RT, WE 1500-125 RT, WE 1500-150 RT 	627362000

Hand guard





	Order no.
 <p>Hand guard</p> <ul style="list-style-type: none"> ■ For fitting under the angle grinder's side support handle when working with the backing pads ■ For all angle grinders 	630327000

Flange nuts and inner support flanges



	Order no.
 <p>Flange nut</p> <ul style="list-style-type: none"> ■ For all angle grinders with M 14-spindle thread 	630706000
 <p>"Quick" flange nut M 14</p> <ul style="list-style-type: none"> ■ For all angle grinders, suitable also for other brands (required free spindle length min. 8 mm); required thread connection M 14; tool-free disc change 	630800000*
 <p>10 "Quick" flange nuts M 14</p> <ul style="list-style-type: none"> ■ For all angle grinders, suitable also for other brands (required free spindle length min. 8 mm); required thread connection M 14; tool-free disc change ■ 10 pieces in attractive counter display (sales unit: 10) 	626411000
 <p>Metabo "Quick" flange nut M 14</p> <ul style="list-style-type: none"> ■ Especially for Metabo Quick system for tool-less disc change at the touch of a button. Suitable for all small Metabo angle grinders with M-Quick spindle button, except W 6-115, W 6-125, WB 11-125 required thread connection M 14 	630802000*
 <p>Quick-locking nut M 14</p> <ul style="list-style-type: none"> ■ Especially for angle grinders up to Ø 150 mm, for tool-free disc change. Required thread connection M 14. ■ Delivery in counter display when ordering 10 pieces (sales unit: 1) 	630832000*
 <p>Inner support flange</p> <ul style="list-style-type: none"> ■ For all angle grinders with M14 spindle thread 	630705000

Dust protection filter

- Filter against coarse particles or chips for longer service life of the machine when working e.g. with ceramic fibre, grinding or cutting discs or polishing with lambswool
- Easy and fast cleaning thanks to exterior metal grid without disturbing connecting ribs
- Tool-free assembly and disassembly

	Order no.
 <p>Dust protection filter</p> <p>For all angle grinders W...12..., W...13..., WE...15..., WE...17... Standard; not suitable for angle grinder with paddle switch and rat tail angle grinder</p>	630709000*
 <p>Dust protection filter</p> <p>For all angle grinders WE...17...RT, WE...19...RT; not suitable for WP 1200-125 RT, WEV 1500-125 RT, WE 1500-125 RT, WE 1500-150 RT</p>	630719000*
 <p>Dust protection filter</p> <p>For all angle grinders WP..12..., WP..13..., WEP..15..., WEP..17... with paddle switch</p>	630792000*
 <p>Dust protection filter</p> <p>For all angle grinders W...9-..., WE...10-..., W...11-...; not suitable for angle grinder with paddle switch and rat tail angle grinder</p>	630835000*









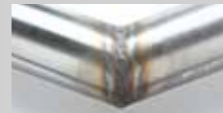
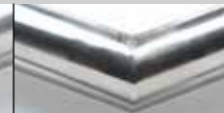

NEW

Flat-pin spanners		Order no.
	Flat-pin spanners For angle grinders with disc diameter 100 mm - 150 mm Version: straight Grinding wheel-Ø: 100/150 mm	623934000*
	Flat-pin spanners For angle grinders with disc diameter 180 mm - 230 mm Version: straight Grinding wheel-Ø: 180/230 mm	623935000*
	Flat-pin spanners For angle grinders with disc Ø 115-230 mm Version: offset Grinding wheel-Ø: 115/230 mm	623910000*

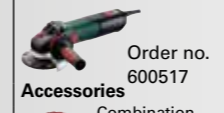
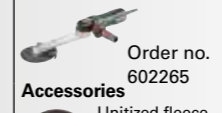
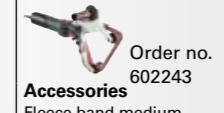





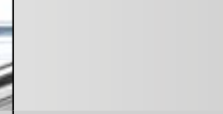
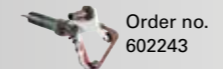
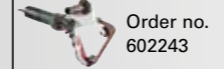
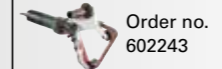
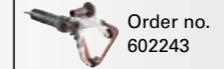
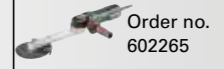
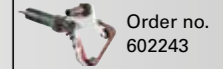



Who wants perfect surfaces,
needs perfect machines and accessories.

Mitred welded pipes

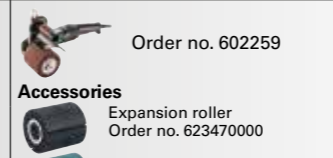
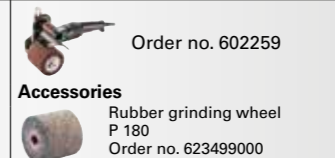
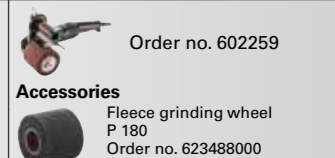
1. SATIN-FINISH					
					
WEV 17-125 Quick Inox	WEV 17-125 Quick Inox	KNSE 9-150	RBE 15-180		
					
Order no. 600517	Order no. 600517 Accessories Combination flap disc medium 626370000	Order no. 602265 Accessories Unitized fleece compact disc medium 626402000	Order no. 602243 Accessories Fleece band medium 626320000		
2. POLISHING					
					
RBE 15-180	RBE 15-180	RBE 15-180	RBE 15-180	KNSE 9-150	RBE 15-180
					
Order no. 602243 Accessories Metabo Pyramid P 400 (A 45) 626313000	Order no. 602243 Accessories Metabo Pyramid P 600 (A 30) 626314000	Order no. 602243 Accessories Metabo Pyramid P 1200 (A 16) 626315000	Order no. 602243 Accessories Metabo Pyramid P 2000 (A 6) 626316000	Order no. 602265 Accessories Unitized compact disc 626401000	Order no. 602243 Accessories Felt band soft 626323000 Polishing paste, blue 623524000

Welded seams on surfaces

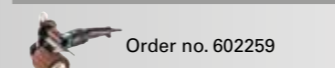
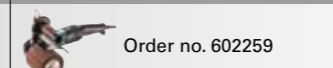
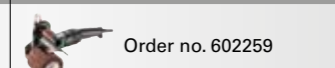
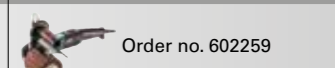
1. SATIN-FINISH			
			
SE 17-200 RT	SE 17-200 RT	SE 17-200 RT	SE 17-200 RT
			
Order no. 602259	Order no. 602259 Accessories Expansion roller Order no. 623470000 Sanding belts 90 x 100/P 80 Order no. 623474000	Order no. 602259 Accessories Rubber grinding wheel P 180 Order no. 623499000	Order no. 602259 Accessories Fleece grinding wheel P 180 Order no. 623488000
2. POLISHING			
			
SE 17-200 RT	SE 17-200 RT	SE 17-200 RT	SE 17-200 RT
			
Order no. 602259 Accessories Expansion roller 623470000 Metabo Pyramid P 400 (A 45) Order no. 626407000	Order no. 602259 Accessories Expansion roller 623470000 Metabo Pyramid P 600 (A 30) Order no. 626408000	Order no. 602259 Accessories Expansion roller 623470000 Metabo Pyramid P 1200 (A 16) Order no. 626409000	Order no. 602259 Accessories Expansion roller 623470000 Metabo Pyramid P 2000 (A 6) Order no. 626410000

* Self-service packaging

01
02
03
04
05
06
07
08
09
10
11
12
13
14
15
16

Accessories for Inox angle grinders

Fleece compact polishing discs »Unitized« - VKS



- Made of compacted fleece material on a fibreglass plate-
- For cleaning and polishing surfaces, for smoothing weld seams; reduces the number of working stages required
- For alloy and high-alloy steels, coloured and light metals, chrome and nickel steels, titanium, steels
- Max. torque: 8,000 /min; 52 m/s, recommended speed: 3,000 min

Diameter x thickness x bore mm	Grit	Sales unit / packing unit	Order no.
125 x 22,23	Very fine	1/1	626368000*
125 x 22,23	Very fine	5/1	626417000

Fleece compact grinding discs »Unitized« - VKS-ZK



- Several layers of pressed fleece material, soaked with resin-bonded abrasive grain (zirconia alumina)
- The addition of abrasive grain covers a range of applications from deburring to soft and flexible finishing jobs. It is suited for deburring, smoothing of weld seams, precise cleaning and finishing of surfaces.
- For alloy and high-alloy steels, coloured and light metals, chrome and nickel steels, titanium, steels
- Profiling of the grinding media possible for precise working. Very low roughing of the processed material.
- Bore 22.23 mm (for angle grinder)
- Max. 10,000 rpm; recommended speed: 3,000 rpm

Diameter x thickness x bore mm	Grit	Sales unit / packing unit	Order no.
125 x 6 x 22,23	Coarse	1/5	626482000
125 x 6 x 22,23	Medium	1/5	626483000

Combination flap disc - KLS



- Made from high-quality pink aluminium oxide fabric in combination with high-quality nylon web.
- For removal of material to fine polish in a single process. Very even grinding/polishing result with good material removal.
- For processing weld seams for example, and for grinding or polishing. For removing minor scratches and damage to the work piece.
- Suitable for grinding, cleaning and finishing work on stainless steel, steel, coloured and light metals, titanium alloys.
- Maximum working speed: 80 m/s
- Recommended speed: 3,000 /min

Diameter x bore mm	Grit	Sales unit / packing unit	Order no.
125 x 22,23	Coarse	1/1	626369000*
125 x 22,23	Coarse	5/1	626415000
125 x 22,23	Medium	1/1	626370000*
125 x 22,23	Medium	5/1	626416000

Flap discs



- Quality class zirconia alumina »Flexiamant Convex«**
- Specially shaped flap disc with lamellae that are rounded off towards the outer edges.
 - Grinding media: Zirconia alumina
 - Thanks to the special design it is particularly suited for processing fillet welds; making faster and more efficient processing possible; also suitable for surface grinding
 - High material removal with very high tool life thanks to the use of zirconia alumina
 - Suitable for processing steel and stainless steel
 - Uniform grinding result, comfortable grinding with only low vibration
 - Maximum working speed 80 m/s

Diameter x bore mm	Grit	Version	Maximum speed /min	Sales unit / packing unit	Order no.
125 x 22,23	P 40	—	12.200	1/10	626462000
125 x 22,23	P 60	—	12.200	1/10	626463000
125 x 22,23	P 80	—	12.200	1/10	626464000



- Quality class ceramic »Flexiamant Super Convex«**
- Specially shaped flap disc with lamellae that are rounded off towards the outer edges.
 - Thanks to the special design it is particularly suited for processing fillet welds; making faster and more efficient processing possible; also suitable for surface grinding
 - Very high material removal with very high tool life thanks to the use of ceramic grain.
 - Cool cut for materials with poor thermal conduction
 - For grinding of steel and stainless steel. Ideal for extreme grinding jobs like processing high-alloy steels, titanium alloys, nickel-based alloys as well as chromium and chromium-nickel steels, brass and bronze thanks to high load capacity.
 - Uniform grinding result, comfortable grinding with only low vibration
 - Maximum working speed 80 m/s

Diameter x bore mm	Grit	Version	Maximum speed /min	Sales unit / packing unit	Order no.
125 x 22,23	P 60	—	12.200	1/10	626460000
125 x 22,23	P 80	—	12.200	1/10	626461000

»Metabo Pyramid« hook and loop sanding sheets



- 3-dimensional structure of the grinding media (pyramid-shaped).
- High material removal with, at the same time, a very even and fine grinding result. Long service life. Faster progress when compared to traditional grinding media thanks to the considerable reduction in the number of working stages.
- For removing scratches, rolling marks on stainless steel. Prepare for polishing.
- Suitable for use throughout the metal industry; especially for stainless steels, titanium, cobalt, nickel, chrome alloys.

Diameter mm	Grit	Sales unit	Order no.
125	P 120 (A 160)	5	626371000*
125	P 280 (A 65)	5	626372000*
125	P 400 (A 45)	5	626373000*
125	P 600 (A 30)	5	626374000*
125	P 1200 (A 16)	5	626403000*
125	P 2000 (A 6)	5	626404000*

Hook and Loop Backing Pad »Metabo Pyramid«



- Hook and loop, with flexible intermediate layer, foam-moulded; for attaching polishing and sanding accessories
- Sanding pad for polishing and medium-hard grinding jobs. Especially recommended for Metabo Pyramid hook and loop sanding sheets

Female thread	Diameter mm	Thickness mm	Sales unit	Order no.
5/8 "	125	3	1	623298000*
M 14	125	3	1	623300000*

Hook and loop fleece compact discs »Unitized« - VKS



- Made from pressed fleece material with hook and loop
- For cleaning and polishing surfaces, for smoothing weld seams; reduces the number of working stages required
- For alloy and high-alloy steels, coloured and light metals, chrome and nickel steels, titanium, steels

Diameter mm	Grit	Sales unit	Order no.
125	Very fine	1	626375000*

* Self-service packaging

Cleaning fleeces



- For the removal of light rust, paint / varnish on metal, cleaning weld seams / steel / copper / aluminium / brass, sanding steel and texturing wood.
- Maximum working speed: 63 m/s
- Recommended speeds at Ø 115 mm: 2,900 /min, Ø 125 mm: 2,700 /min

Diameter x bore mm	Sales unit	Order no.
115 x 22,23	1	624346000*
125 x 22,23	1	624347000*

Accessories for fillet weld grinders

Fleece compact grinding discs »Unitized« - VKS



- Made from pressed fleece material
- For cleaning and polishing surfaces, for smoothing weld seams; reduces the number of working stages required
- For alloy and high-alloy steels, coloured and light metals, chrome and nickel steels, titanium, steels
- The fleece compact disc can be shaped with the profiling file (626396000)
- Maximum working speed: 60 m/s
- Maximum speed: 6,000 /min
- Recommended speed: 3,000 /min

Diameter x thickness x bore mm	Grit	Sales unit	Order no.
150 x 3 x 25,4	Medium	1	626400000*
150 x 6 x 25,4	Very fine	1	626401000*
150 x 6 x 25,4	Medium	1	626402000*

Felt disc



- For polishing stainless steel and non-ferrous metals, always in conjunction with a polishing paste.
- Maximum working speed: 31 m/s
- Maximum speed: 3,900 /min
- Recommended speed: 600-1,100 /min

Diameter x thickness x bore mm	Grit	Sales unit	Order no.
150 x 5 x 25,4	Soft	1	626395000*

Accessories for burnishing machines

Expansion rollers



Expansion roller

- For using sanding belts and abrasive sleeves. The sanding belts/ abrasive sleeves are pushed over the roller and clamped securely by centrifugal force

Diameter: 90 mm
Width: 100 mm

Order no.

623470000



Inflatable expansion roller

- For using sanding belts and abrasive sleeves. The sanding belts/ abrasive sleeves are pushed over the roller. The air volume in the roller is adjusted individually.
- Ideal for easy processing of contours

Diameter: 90 mm
Width: 100 mm

Order no.

623542000

Sanding belts 90 x 100 mm

Diameter mm	Width mm	Grit	Sales unit	Order no.
-------------	----------	------	------------	-----------



Sanding belts with zirconia alumina 90x100 mm

- Material: zirconia alumina for grit P 40, 60, 80, 120/ aluminium oxide for grit P 220
- Suitable for all metals and even stainless steel
- For removing scratches and smoothing weld seams
- Only in combination with the expansion roller 623470000
- Maximum working speed: 30 m/s; recommended: 20 m/s

90	100	P 40	10	623512000
90	100	P 60	10	623473000
90	100	P 80	10	623474000
90	100	P 120	10	623475000
90	100	P 220	10	623476000

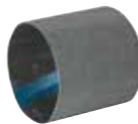

»Metabo Pyramid« sanding belts 90 x 100 mm

- For all metal uses, particularly suited to the processing of rust-free steel/stainless steel
- 3-dimensional structure of the grinding media (pyramid-shaped). High material removal with, at the same time, a very even and fine grinding result for the entire lifetime of the product.
- Quick progress; considerably reduces the number of working stages compared to traditional grinding methods.
- Maximum speed: 6,400 /min; recommended speed: 4,200 /min

90	100	P 120 (A 160)	5	626405000*
90	100	P 280 (A 65)	5	626406000*
90	100	P 400 (A 45)	5	626407000*
90	100	P 600 (A 30)	5	626408000*
90	100	P 1200 (A 16)	5	626409000*
90	100	P 2000 (A 6)	5	626410000*

Fleece sanding sleeves



- For removing scratches and oxide layers, tarnishing, satin-finish, deburring and fine grinding
- Only in combination with the expansion roller
- Maximum speed: 6,400 /min; recommended speed: 3,200 /min

Diameter mm	Width mm	Version	Sales unit	Order no.
90	100	Coarse	2	623519000
90	100	Medium	2	623495000
90	100	Fine	2	623496000

* Self-service packaging

Lamellar grinding wheels



- For removing rust, oxide layers, scratches
- For texturing and satin-finish of metal
- Maximum speed: 5,800 /min; recommended speed: 3,200 /min

Diameter mm	Width mm	Grit	Sales unit	Order no.
105	100	P 40	1	623477000
105	100	P 60	1	623513000
105	100	P 80	1	623479000
105	100	P 120	1	623480000
105	100	P 180	1	623481000
105	100	P 240	1	623482000

Flap wheels/fleece grinding wheels



- Pink aluminium oxide grinding lamellae combined with grain-coated nylon web
- For tarnishing, satin-finish and removing scratches on metal
- Removing old paint and smoothing wood materials
- Maximum speed: 5,600 /min; recommended speed: 2,900 /min

Diameter mm	Width mm	Grit	Sales unit	Order no.
105	100	P 60	1	623483000
105	100	P 80	1	623484000
105	100	P 180	1	623485000
105	50	P 60	1	623526000
105	50	P 80	1	623527000
105	50	P 180	1	623528000

Fleece grinding wheels



- Elastic grain-coated nylon web for shadow-free tarnishing, satin-finish and polishing of special steel and non-ferrous metals
- For use on wood to smooth surfaces
- Maximum speed: 5,600 /min; recommended speed: 2,900 /min, Ø 115 mm: 2,600 /min

Diameter mm	Width mm	Grit	Sales unit	Order no.
105	100	P 60	1	623486000
105	100	P 80	1	623487000
105	100	P 180	1	623488000
105	100	P 280	1	623514000
115	100	P 400	1	623468000
115	100	P 600	1	623469000
115	100	P 900	1	623494000

Corrugated Fleece Sanding/Grinding Wheel



- For transition-free matt and satin-finishes on stainless steel surfaces and non-ferrous metals
- For removing minor scratches and for cleaning surfaces
- Elastic nylon fleece containing grit with a corrugated arrangement on the core
- Maximum speed: 5,900 /min; recommended speed: 3,000 /min

Diameter mm	Width mm	Grit	Sales unit	Order no.
100	100	P 180	1	623567000

Hard fleece grinding wheel



- For cleaning and descaling weld seams
- Removing rust, oxide layers and paint
- Strong longitudinal grinding of stainless steel
- Maximum speed: 5,400 /min; recommended speed: 2,800 /min

Diameter mm	Width mm	Grit	Sales unit	Order no.
110	100	P 46	1	623525000

Rubber grinding wheels



- Rubber mix with silicone carbide abrasive grains
- For removing small scratches. For bright shining, decorative longitudinal grinding of stainless steel and non-ferrous metals
- Maximum speed: 2,700 /min; recommended speed: 1,400 /min

Diameter mm	Width mm	Grit	Sales unit	Order no.
105	100	P 60	1	623510000
105	100	P 180	1	623499000

Polishing discs



Sisal polishing rings

- For pre-polishing steel and stainless steel in conjunction with the white polishing paste 623520000
 - Maximum speed: 6,100 /min; recommended speed: 1,900 /min
- Diameter: 100 mm
Width: 15 mm
Version: impregnated
Sales unit: 5

Order no.
623507000



Nylon web polishing rings

- For pre-polishing non-ferrous steel in conjunction with the brown polishing paste 623522000
 - Maximum speed: 6,100 /min; recommended speed: 1,900 /min
- Diameter: 100 mm
Width: 10 mm
Version: hard
Sales unit: 8

623508000



Nylon web polishing rings

- For high-gloss polishing of all metals in conjunction with the blue polishing paste 623524000
 - Maximum speed: 6,100 /min; recommended speed: 1,900 /min
- Diameter: 100 mm
Width: 10 mm
Version: soft
Sales unit: 8

623509000

Polishing pastes



Polishing paste, white

- For pre-polishing and polishing stainless steel
- Weight: 250 g

Order no.
623520000



Polishing paste, brown

- For pre-polishing and polishing non-ferrous metals
- Weight: 250 g

623522000

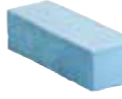

Polishing paste, blue

- For high-gloss polishing of all metals
- Weight: 250 g

623524000

Steel-wire wheel brushes brass

- For rust removal, deburring and cleaning metal
- For brushing out soft annual rings on wood
- Maximum speed: 6,000 /min; recommended speed: 3,000 - 4,500 /min

	Diameter mm	Width mm	Wire thickness	Order no.
	100	70	0,27 mm	623501000

Steel-wire wheel brushes, Inox

- With stainless wire. For cleaning weld seams, deburring, rust removal, roughening
- Maximum speed: 6,000 /min; recommended speed: 2,400 - 3,900 /min

	Diameter mm	Width mm	Wire thickness	Order no.
	100	70	0,20 mm	623503000

Plastic wheel brushes

- Elastic, grain-coated wheel brush for roughening and deburring metal
- For rustic effects on wood
- Maximum speed: 6,000 /min; recommended speed: 2,400 - 3,900 /min

	Diameter mm	Width mm	Order no.
	100	70	623505000

Fibre wheel brush

- For use on wood-based materials. For polishing stained wood materials.
- For producing a dull finish. Dust removal and cleaning.
- Maximum speed: 6,000 /min; recommended speed: 2,400 - 3,900 /min

	Diameter mm	Width mm	Order no.
	100	100	623506000

Spacer rings

	Order no.
 3 Spacer rings ■ For width compensation when using grinding rollers, brushes, polishing rings	623511000

Sanding belt



- Sanding belt**
- With corrugated surface for non-slip work with sanding belts, nylon web and felt band
- Diameter: 85 mm
Width: 70 mm

Order no.
623529000

Adhesive tape



- Adhesive tape**
- For re-closing the sanding belts

Order no.
623530000

Fleece bands



- For fine grinding or polishing, also on "closed" pipe constructions
- Resealable by "buttonhole closure"
- Only in conjunction with sanding belt 623529000

Length mm	Width mm	Version	Sales unit	Order no.
660	30	Coarse	3	623536000
660	30	Medium	3	623537000
660	30	Fine	3	623538000
660	30	Extra fine	3	623539000

Felt band



- Felt band**
- For polishing work, also on "closed" pipe constructions
 - Can be used on both sides
 - Resealable by "buttonhole closure"
 - Only in conjunction with sanding belt 623529000
- Length: 600 mm
Width: 30 mm
Sales unit: 1

Order no.
623541000

Guard 50 mm incl. mounting arbor



- The guard and the mounting arbor have been specially designed for use with 50 mm wide lamellar / fleece grinding discs and fleece grinding wheels. This permits working near edges.

	Order no.
Guard 50 mm incl. mounting arbor 5/8"	626413000
Guard 50 mm incl. mounting arbor M 14	626414000

* Self-service packaging

Accessories for tube belt sanders

Aluminium oxide sanding belts



- For use throughout the metal industry. Flexible grinding material, dense with stable cotton base.
- Good material removal with good tool life. Uniform grinding result.
- Recommended circumferential speed: 25-35 m/s

Dimensions mm	Grit	Sales unit	Order no.
30 x 533	P 120	10	626279000*
30 x 533	P 180	10	626280000*
30 x 533	P 240	10	626281000*
30 x 533	P 320	10	626282000*
30 x 533	P 400	10	626283000*
40 x 760	P 120	10	626300000*
40 x 760	P 180	10	626301000*
40 x 760	P 240	10	626302000*
40 x 760	P 320	10	626303000*
40 x 760	P 400	10	626304000*

Zirconia alumina sanding belts



- For all metal uses, particularly suited for processing stainless steels/Inox. High performance sanding belt, dense with cotton base.
- High material removal with good service life. Even grinding result.
- For rough-polishing and deburring of steel and stainless steel
- Recommended circumferential speed: 25-35 m/s

Dimensions mm	Grit	Sales unit	Order no.
30 x 533	P 60	10	626284000*
30 x 533	P 80	10	626285000*
30 x 533	P 120	10	626286000*
40 x 760	P 60	10	626305000*
40 x 760	P 80	10	626306000*
40 x 760	P 120	10	626307000*

Ceramic grain sanding belts



- For all metal uses, particularly suited for processing stainless steels/Inox. Flexible high performance sanding belt, semi-open coarseness with cotton base
- Extremely high material removal with extremely high tool life thanks to the self-sharpening ceramic grain. Even grinding and best results.
- For pre-polishing and fine polishing, for example, of contours, profiles, etc.
- Recommended circumferential speed: 25-35 m/s for stainless steel
- Recommended circumferential speed: 20-30 m/s for NF metals
- Recommended circumferential speed: 5-10 m/s for high temperature Ni-/Co steels

Dimensions mm	Grit	Sales unit	Order no.
40 x 760	P 60	10	626308000*
40 x 760	P 80	10	626309000*
40 x 760	P 120	10	626310000*

»Metabo Pyramid« sanding belts



- For all metal uses, particularly suited to the processing of rust-free steel/stainless steel
- 3-dimensional structure of the grinding media (pyramid-shaped). High material removal with, at the same time, a very even and fine grinding result for the entire lifetime of the product.
- Quick progress; considerably reduces the number of working stages compared to traditional grinding methods.
- Special product for processing of lightly and heavily profiled elements in the stainless steel industry.
- Recommended circumferential speed: 2.7-8.5 m/s

Dimensions mm	Grit	Sales unit	Order no.
30 x 533	P 120 (A 160)	5	626290000*
30 x 533	P 280 (A 65)	5	626291000*
30 x 533	P 400 (A 45)	5	626292000*
30 x 533	P 600 (A 30)	5	626293000*
30 x 533	P 1200 (A 16)	5	626294000*
30 x 533	P 2000 (A6)	5	626295000*
40 x 760	P 120 (A 160)	5	626311000*
40 x 760	P 280 (A 65)	5	626312000*
40 x 760	P 400 (A 45)	5	626313000*
40 x 760	P 600 (A 30)	5	626314000*
40 x 760	P 1200 (A 16)	5	626315000*
40 x 760	P 2000 (A6)	5	626316000*

Fleece bands



- For grinding, cleaning and finishing work. For removing scratches, colour runs and oxide layers.
- For preparing, pre-grinding and polishing weld seams
- Recommended circumferential speed: 25-30 m/s for steel
- Recommended circumferential speed: 15-25 m/s for stainless steel
- Recommended circumferential speed: 30-40 m/s for soft NF metals
- Recommended circumferential speed: 5-15 m/s for high temperature Ni-/ Co alloys

Dimensions mm	Grit	Sales unit	Order no.
30 x 533	Coarse	3	626296000*
30 x 533	Medium	3	626297000*
30 x 533	Very fine	3	626298000*
40 x 760	Coarse	3	626319000*
40 x 760	Medium	3	626320000*
40 x 760	Very fine	3	626322000*

Felt band



- For polishing stainless steel and non-ferrous metals, always in conjunction with a polishing paste.
- Recommended circumferential speed: 10-20 m/s

Dimensions mm	Grit	Sales unit	Order no.
30 x 533	Soft	1	626299000*
40 x 760	Soft	1	626323000*

Polishing pastes



- Polishing paste, white**
- For pre-polishing and polishing steel and stainless steel; weight: 250 g



- Polishing paste, brown**
- For pre-polishing and polishing of NF metals; weight: 250 g



- Polishing paste, blue**
- For high-gloss polishing of all metals; weight: 250 g

* Self-service packaging

01
02
03
04
05
06
07
08
09
10
11
12
13
14
15
16

Accessories for band files

Zirconia alumina sanding belts



- For all metal uses, particularly suited to the processing of rust-free steel/stainless steel. Grinding material with cotton base.
- High material removal with good service life. Even grinding result.
- For rough-polishing and deburring of steel and stainless steel
- Recommended circumferential speed: 15-25 m/s

Dimensions mm	Grit	Sales unit	Order no.
6 x 457	P 40	10	626344000*
6 x 457	P 60	10	626345000*
6 x 457	P 80	10	626346000*
6 x 457	P 120	10	626347000*
13 x 457	P 40	10	626348000*
13 x 457	P 60	10	626349000*
13 x 457	P 80	10	626350000*
13 x 457	P 120	10	626351000*
19 x 457	P 40	10	626352000*
19 x 457	P 60	10	626353000*
19 x 457	P 80	10	626354000*
19 x 457	P 120	10	626355000*

Ceramic grain sanding belts



- For all metal uses, particularly suited to the processing of rust-free steel/stainless steel. Grinding material with cotton base.
- Extremely high material removal with extremely high tool life thanks to the self-sharpening ceramic grain. Even grinding and best results.
- For pre-polishing and fine polishing, for example, of contours, profiles, etc.
- Recommended circumferential speed: 15-25 m/s for stainless steel
- Recommended circumferential speed: 20-30 m/s for NF metals
- Recommended circumferential speed: 5-10 m/s for high temperature Ni-/ Co- alloys

Dimensions mm	Grit	Sales unit	Order no.
13 x 457	P 40	10	626360000*
13 x 457	P 60	10	626361000*
13 x 457	P 80	10	626362000*
13 x 457	P 120	10	626363000*

Fleece bands



- For grinding, cleaning and finishing work. For removing scratches, colour runs and oxide layers.
- For preparing, pre-grinding and polishing weld seams
- Recommended circumferential speed: 25-30 m/s for steel
- Recommended circumferential speed: 15-25 m/s for stainless steel
- Recommended circumferential speed: 30-40 m/s for soft NF metals
- Recommended circumferential speed: 5-15 m/s for high temperature Ni-/ Co alloys

Dimensions mm	Grit	Sales unit	Order no.
6 x 457	Coarse	5	626383000*
6 x 457	Medium	5	626384000*
6 x 457	Very fine	5	626386000*
13 x 457	Coarse	5	626387000*
13 x 457	Medium	5	626388000*
13 x 457	Very fine	5	626390000*

Dimensions mm	Grit	Sales unit	Order no.
19 x 457	Coarse	5	626391000*
19 x 457	Medium	5	626392000*
19 x 457	Very fine	5	626394000*

Sanding belt arms



- Sanding belt arm 1**
- Standard equipment of the machine. Suitable for sanding belts 6 x 457 mm and 13 x 457 mm.
 - For sanding narrow areas, weld seams, deburring edges, sanding grooved sections on tongued and groove boards.



- Sanding belt arm 2**
- Suitable for sanding belts 6 x 457 mm.
 - For sanding narrow areas, edges, deburring pipes, sanding grooved sections on tongued and groove boards.



- Sanding belt arm 3**
- Suitable for sanding belts 13 x 457 mm
 - For sanding edges, deburring pipes, sanding blunt welds.

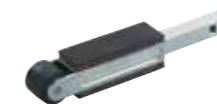

- Sanding belt arm 4**
- Suitable for sanding belts 19 x 457 mm.
 - For grinding of edges and surfaces and for grinding out of radii and transitions

Additional accessories for band files



- Adapter band file**
- For extension of the sanding belt arms. For the use of sanding belts with a belt length of 520 mm and 533 mm.

General accessories for processing stainless steel



- Stainless steel adhesive tape**
- For mitre cuts of welded stainless steel profiles.
 - Dimensions: 2.5 m x 40 x 0.15 mm



- 3 Micro-fibre cloths 380 x 380 mm**
- For cleaning and evenly distributing protective media and polishes, for removing pastes and cream residue
 - Suitable for all metals and hard plastics



- Stainless steel cleaning spray 400 ml**
- For cleaning, conserving and sealing of surfaces, especially on stainless steels.



- Vienna lime chalk**
- For cleaning, caring and polishing of smooth surfaces, especially stainless steel, silver, brass, glass, ceramic etc.
 - Contents: 300 g, shaker

* Self-service packaging

Ready for any application: System solutions for die grinders.

Whether you remove fine burrs or want to grind surfaces in hard to reach places, we have the right die grinder for you. The machines impress with their slim design and details, like for example, the spindle lock for easy and fast tool change. An extensive range of accessories, compliment the different die grinders, permitting precise and safe working in the different application areas.

Flexible shafts



Speeds of 20,000 to 30,000 rpm
Order no. 627609000



Speeds of 7,500 to 30,000 rpm
Order no. 630980000

Tensioning frame



Order no. 628329000



High speed



GE 710 Compact
Order no. 600615



G 400
Order no. 600427



GE 710 Plus
Order no. 600616



GA 18 LTX
Order no. 600638



GE 950 G Plus
Order no. 600618



GA 18 LTX G
Order no. 600639

Carbide cutter



Corundum mounted points



Flap wheels



Always the right collet for your accessories



For die grinders



For flexible shaft
630980000



For flexible shaft
627609000

Collet bore	Version	Order no.	Collet bore	Order no.	Collet bore	Order no.
3 mm	Hexagon	631947000	3 mm	630976000	3 mm	630715000
6 mm	Hexagon	631945000	6 mm	630977000	6 mm	630714000
6 mm	Double flat	630820000	8 mm	630979000		
8 mm	Double flat	630833000				
8 mm	Hexagon	631946000				
1/8" (3,18 mm)	Hexagon	631948000				
1/4" (6,35 mm)	Hexagon	631949000				
1/4" (6,35 mm)	Double flat	630821000				

Carbide router bits

- Carbide head made from high-quality carbide with a percentage of Cobalt
- Specially hardened steel shaft
- Special copper soldering material for a safe connection
- 100% control of the soldering joint

Design wave shape

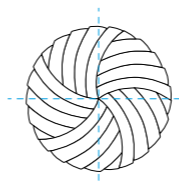

Wave shape geometry

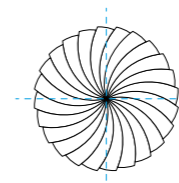

Centred teeth

Carbide router bits with round spur cutting edges are produced with a wave geometry; this results in improved ease of cutting at the end of the tool.

Shapes and applications at a glance

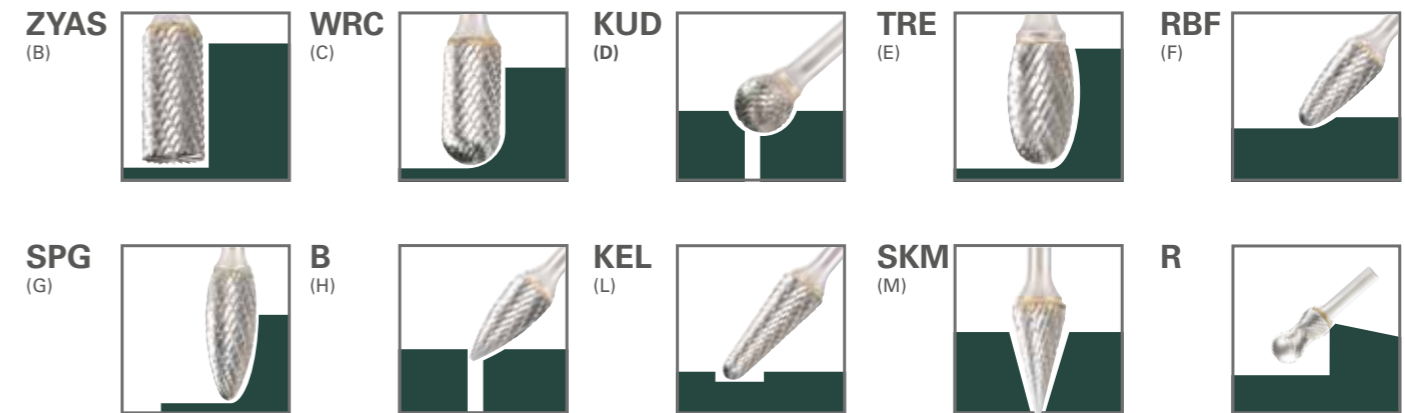

Recommended cutting speeds for different material groups:

Material groups	Serration	Cutting speed
Steel and die-cast materials	Cross-cut serration MX	Construction steels Carbon steels Tool steels Non-alloy steels Case-hardening steels Cast steel 450 - 600 m/min
		Hardened, heat-treated steels over 1,200 N/mm (>35 HRC) Tool steels Heat-treated steels Alloy steels Cast steel 250 - 350 m/min
Stainless steels	Cross-cut serration MX	Steels resistant to rust and acid Austenitic and ferrous stainless steels 250 - 350 m/min
NF Metals	Aluminium serration ALU	Soft NF metals Aluminium Brass Copper Zinc 600 - 900 m/min
		High temperature-resistant materials Nickel-base alloys Ni-Co alloys 300 - 450 m/min
Cast iron materials	Cross-cut serration MX	Grey cast iron Ductile cast iron 450 - 600 m/min

Example: Material group: Stainless steel
Serration: cross / MX Cutting speed: 250 - 350 m/min
Cutter head Ø 8 mm **Recommended speed range: 10,000 - 14,000 /min**

Recommended speed range:

Head Ø (mm)	Cutting speeds (m/min)					
	250	300	350	450	600	900
6	13.000	16.000	19.000	24.000	32.000	
8	10.000	12.000	14.000	18.000	24.000	
9,6	8.000	10.000	12.000	15.000	20.000	
12,7	6.000	7.500	9.000	11.000	15.000	23.000

Router bits

Carbide router bits

- Carbide burrs with cross-cut serration for general applications. The cross-cut serration permits comfortable working and better control. Thanks to the improved ease of cutting, the material removal is increased. Suitable for almost all metals, such as hardened and unhardened steel, stainless steel, titanium, brass, copper, cast iron, bronze.
- Application examples: Deburring, machining of contours, processing of surfaces, milling of hard to reach places, machining of narrow angles

	Head Ø mm	Working length mm	Overall length mm	Shaft Ø mm	Serration	Order no.
Cylindrical rotary burr, ZYAS shape (with spur serration) For general applications. Ideally suited for inner contours.						
ZYAS	6	18	50	6	Cross-cut serration	628341000*
	8	20	64	6	Cross-cut serration	628342000*
	10	20	64	6	Cross-cut serration	628343000*
	12	25	70	6	Cross-cut serration	628344000*
Radius end router bit, WRC shape For processing surfaces, contours and radii.						
WRC	6	18	50	6	Cross-cut serration	628345000*
	8	20	64	6	Cross-cut serration	628346000*
	10	20	64	6	Cross-cut serration	628347000*
	12	25	70	6	Cross-cut serration	628348000*
Router bit, ball shape, KUD shape To process contours and deburring of internal bores. Particularly for milling in hard to reach areas.						
KUD	6	5	50	6	Cross-cut serration	628349000*
	8	6	52	6	Cross-cut serration	628350000*
	10	8	54	6	Cross-cut serration	628351000*
	12	11	56	6	Cross-cut serration	628352000*
Router bit, drop shape, TRE shape For general applications.						
TRE	6	10	50	6	Cross-cut serration	628372000*
	8	15	60	6	Cross-cut serration	628373000*
	10	16	60	6	Cross-cut serration	628402000*
	12	22	67	6	Cross-cut serration	628374000*
Router bit, semi-circular shape, RBF shape For processing narrow workpieces.						
RBF	6	18	50	6	Cross-cut serration	628353000*
	8	20	65	6	Cross-cut serration	628354000*
	10	20	64	6	Cross-cut serration	628355000*
	12	25	70	6	Cross-cut serration	628356000*
Router bit, pointed arch shape, SPG shape For the processing of acute angles.						
SPG	6	18	50	6	Cross-cut serration	628357000*
	8	20	64	6	Cross-cut serration	628358000*
	10	20	64	6	Cross-cut serration	628359000*
	12	25	70	6	Cross-cut serration	628360000*
Router bit flame shape, B shape For general applications.						
B	6	14	50	6	Cross-cut serration	628361000*
	8	20	64	6	Cross-cut serration	628362000*
	10	20	65	6	Cross-cut serration	628363000*
	12	32	77	6	Cross-cut serration	628364000*

	Head Ø mm	Working length mm	Overall length mm	Shaft Ø mm	Serration	Order no.
Router bit round taper shape, KEL shape For processing hard to reach areas.						
KEL	6	18	50	6	Cross-cut serration	628401000*
	8	25	70	6	Cross-cut serration	628365000*
	10	30	76	6	Cross-cut serration	628366000*
	12	32	77	6	Cross-cut serration	628367000*
Router bit, pointed cone shape, SKM shape For processing hard to reach areas. Ideally suited for model construction. The conical shape permits the cutting of continuous diameters.						
SKM	6	20	50	6	Cross-cut serration	628368000*
	8	18	64	6	Cross-cut serration	628369000*
	10	20	64	6	Cross-cut serration	628370000*
	12	22	71	6	Cross-cut serration	628371000*
Radius rotary burr Unparalleled conical rotary burr with special curved structure. The specially developed guide system prevents the cutter sliding off the work piece. Therefore it is ideally suited for fine radii at sharp corners/edges and good control over sharp edges. The special groove geometry (overlapping standard serration in the bit centre) permits fine milling on all surfaces and quick material removal with long service life. The smooth face side helps guiding the cutter and protects the surface from damage. Specially developed for achieving radius chamfers in hard materials such as steel, stainless steel, cast iron, titanium, bronze, copper, brass, etc.						
R	12	16	70	6	Simple serration	628378000*

Carbide router bits for aluminium



- Carbide burr with special aluminium serration for processing soft, long-chip materials such as aluminium and plastics. The aluminium serration permits a high chip removal rate and high cutting performance with smooth operation.
- Application examples: Deburring, machining of contours, processing of surfaces, milling of hard to reach places, machining of narrow angles

	Head Ø mm	Working length mm	Overall length mm	Shaft Ø mm	Serration	Order no.
Cylindrical router bit, ZYAS shape/ Alu (with spur serration) Ideal for inside contours and general applications						
ZYAS	12	25	70	6	Aluminium serration	628375000*
Router bit, radius end, WRC shape/ Alu For processing surfaces, contours and radii						
WRC	12	25	70	6	Aluminium serration	628377000*
Router bit, spherical shape, KUD shape/ Alu For processing contours and deburring of internal bores						
KUD	12	11	56	6	Aluminium serration	628376000*

* Self-service packaging

Carbide burr sets





- Carbide burrs with cross-cut serration for general applications. The Cross-cut serration permits comfortable working and better control. Thanks to the improved ease of cutting, the material removal is increased. Suitable for almost all metals, such as hardened and unhardened steel, stainless steel, titanium, brass, copper, cast iron, bronze.
- Application examples: Deburring, machining of contours, processing of surfaces, milling of hard to reach places, machining of narrow angles

	Order no.
 <p>Carbide burr set Contents: 1 x Order no.: head-Ø x working length x overall length, shaft-Ø, shape 1 x 628343000: ZYAS 102064, Cylinder / B-shape 1 x 628347000: WRC 102064, Radius end/C shape 1 x 628351000: KUD 100854, Sphere/D shape 1 x 628402000: TRE 101660, Ellipse/E shape 1 x 628359000: SPG 102064, Pointed arch/G shape</p>	628403000*
 <p>Carbide burr set Contents: 1 x Order no.: head-Ø x working length x overall length, shaft-Ø, shape 1 x 628343000: ZYAS 102064, Cylinder / B-shape 1 x 628344000: ZYAS 122570, Cylinder / B-shape 1 x 628347000: WRC 102064, Radius end/C shape 1 x 628348000: WRC 122570, Radius end/C shape 1 x 628352000: KUD 121156, Sphere/D shape 1 x 628402000: TRE 101660, Ellipse/E shape 1 x 628356000: RBF 122570, Round arch/F shape 1 x 628359000: SPG 102064, Pointed arch/G shape 1 x 628360000: SPG 122570, Pointed arch/G shape 1 x 628367000: KEL 123277, Round cone/L shape</p>	628404000*
 <p>Carbide router bit display Contents: 2 x Order no.: head-Ø x working length x overall length, shaft-Ø, shape 2 x 628341000: ZYAS 061850, Cylinder / B-shape 2 x 628345000: WRC 061850, Radius end/C shape 2 x 628353000: RBF 061850, Round arch/F shape 2 x 628357000: SPG 061850, Pointed arch/G shape 2 x 628401000: KEL 061850, Round cone/L shape 2 x 628346000: WRC 082064, Radius end/C shape 2 x 628354000: RBF 082065, Round arch/F shape 2 x 628358000: SPG 082064, Pointed arch/G shape 2 x 628365000: KEL 082570, Round cone/L shape 2 x 628343000: ZYAS 102064, Cylinder / B-shape 2 x 628347000: WRC 102064, Radius end/C shape 2 x 628355000: RBF 102064, Round arch/F shape 2 x 628359000: SPG 102064, Pointed arch/G shape 2 x 628366000: KEL 103076, Round cone/L shape 2 x 628344000: ZYAS 122570, Cylinder / B-shape 1 x 628348000: WRC 122570, Radius end/C shape 2 x 628356000: RBF 122570, Round arch/F shape 2 x 628360000: SPG 122570, Pointed arch/G shape 2 x 628367000: KEL 123277, Round cone/L shape 2 x 628402000: TRE 101660, Ellipse/E shape</p>	628405000

Corundum mounted points

Mounted points made of pink aluminium oxide





- Mounted points made from pink aluminium oxide for steel and cast steel
- For the preparation of weld seams, processing of weld seams
- Rough machining to fine processing
- For deburring and buffing

	Head Ø mm	Working length mm	Overall length mm	Shaft Ø mm	Grit	Order no.
	16	32	40	6	K 46	628330000*
	25	25	40	6	K 36	628331000*
	16	32	40	6	K 46	628332000*
	25	25	40	6	K 36	628333000*
	20	32	40	6	K 36	628334000*

	Order no.
 <p>Mounted points made from pink aluminium oxide in a set ■ Mounted points made from pink aluminium oxide for steel and cast steel ■ Ideal for the preparation of weld seams, processing of weld seams ■ Rough machining to fine processing ■ Deburring ■ Plastering Contents: 1 x Order no.: head-Ø x working length x shaft length, shaft-Ø, grit, shape 1 x 628330000: 16 x 32 x 40 mm, 6 mm, K 46, Cylinders 1 x 628331000: 25 x 25 x 40 mm, 6 mm, K 36, Cylinders 1 x 628332000: 16 x 32 x 40 mm, 6 mm, K 46, Taper 1 x 628333000: 25 x 25 x 40 mm, 6 mm, K 36, Ball 1 x 628334000: 20 x 32 x 40 mm, 6 mm, K 36, Pointed arch</p>	628335000*

Mounted points made of aluminium oxide

- Mounted points made of aluminium oxide for processing stainless steel, Inox, NK 24 N BA, soft version, free from iron and sulphur
- For the preparation of weld seams, processing of weld seams
- Rough machining to fine processing
- For deburring and buffing

	Head Ø mm	Working length mm	Overall length mm	Shaft Ø mm	Grit	Order no.
	20	32	40	6	K 24	628336000*
	25	32	40	6	K 24	628337000*
	32	32	40	6	K 24	628338000*
	40	20	40	6	K 24	628339000*
	50	10	40	6	K 24	628340000*

* Self-service packaging

Flap wheels



- Aluminium oxide flap wheels
- For processing profiled workpieces, inner surfaces, narrow and hard to reach areas. Particularly for radial use.
- Ideal for smoothing, rust removal, buffing, deburring; rough grinding of steel; processing of steel surfaces; tarnishing; flat surface grinding; effect grinding

Diameter x width mm	Shaft Ø mm	Grit	Maximum speed /min	Sales unit	Order no.
Ø 50 x 20	6	P 40	15.200	1	628379000*
Ø 50 x 20	6	P 60	15.200	1	631110000*
Ø 50 x 20	6	P 80	15.200	1	628380000*
Ø 60 x 20	6	P 40	12.700	1	628381000*
Ø 60 x 20	6	P 60	12.700	1	628382000*
Ø 60 x 20	6	P 80	12.700	1	628383000*
Ø 60 x 30	6	P 40	12.700	1	628384000*
Ø 60 x 30	6	P 60	12.700	1	631111000*
Ø 60 x 30	6	P 80	12.700	1	628385000*
Ø 60 x 30	6	P 120	12.700	1	628386000*
Ø 60 x 30	6	P 180	12.700	1	628387000*
Ø 60 x 30	6	P 240	12.700	1	628388000*
Ø 60 x 40	6	P 40	12.700	1	628389000*
Ø 60 x 40	6	P 60	12.700	1	631112000*
Ø 80 x 30	6	P 40	9.500	1	628391000*
Ø 80 x 30	6	P 60	9.500	1	628392000*
Ø 80 x 30	6	P 80	9.500	1	628393000*
Ø 80 x 30	6	P 120	9.500	1	628394000*
Ø 80 x 40	6	P 40	9.500	1	628395000*
Ø 80 x 40	6	P 60	9.500	1	628396000*
Ø 80 x 40	6	P 80	9.500	1	628397000*
Ø 80 x 50	6	P 40	9.500	1	628398000*
Ø 80 x 50	6	P 60	9.500	1	628399000*
Ø 80 x 50	6	P 80	9.500	1	628400000*

Small grinding discs

Quality class A 24-Q »Flexiamant Super« steel



- Universal disc for all aspects of metal processing, particularly suitable for deburring and grinding edges, also for cast processing
- Hardness: hard
- Good material removal with extremely good tool life

Diameter x thickness x bore mm	Maximum speed /min	Maximum working speed m/s	Sales unit / packing unit	Suitable for machine	Order no.
50 x 6 x 6	30.600	80	1/25		630187000

Small cutting discs

Quality class A 46-U 9 »Flexiamant Super« Inox



- High-output disc especially for processing stainless steel
- Maximum cutting output with very long tool life by using special corundums. Free from iron, sulphur and chlorine (Fe + S + Cl ≤ 0.1 %), for all rust and acid resistant steels (V2A, Nirosta, INOX), spring steels, tool steels
- For use in the manufacture of vehicles, containers, car bodies, switch cabinets etc. Cutting discs for quiet, precise cutting cuts without burrs
- Hardness: hard

Diameter x thickness x bore mm	Maximum speed /min	Maximum working speed m/s	Sales unit / packing unit	Suitable for machine	Order no.
50 x 1 x 6	30.600	80	1/50		630191000
50 x 2 x 6	30.600	80	1/25		630192000
76 x 2 x 6	20.100	80	1/25		630194000
76 x 1,1 x 6	20.100	80	1/50		630195000
Mounting arbor for small cutting discs					630189000*

Collets for die grinder



Collet bore	Version	Order no.
3 mm	Hexagon	631947000*
6 mm	Hexagon	631945000*
6 mm	Double flat	630820000
8 mm	Double flat	630833000
8 mm	Hexagon	631946000*
1/8" (3,18 mm)	Hexagon	631948000*
1/4" (6,35 mm)	Hexagon	631949000
1/4" (6,35 mm)	Double flat	630821000

Flexible shafts



Flexible shaft 27609

- Suitable for speeds of 20,000 to 30,000 rpm
- Bearing-mounted at both ends
- For router bits, mounted points, flap wheels etc. with 6 mm shaft diameter. Interchangeable collet for accessories with 3 mm shaft diameter available as accessory (630715000)
- 6 mm driving shaft for fixing the flexible shaft in the collet bore of the drive machine. If the collet bore of the drive machine has a different dimension than 6 mm, the collet of the drive machine must be changed. 6 mm collet available as accessory (631945000)

Suitable for routers: FME 737
 Suitable for die grinders: G 400, GE 710 Compact, GE 710 Plus, GA 18 LTX
 Length: 1.3 m
 Driving shaft: 6 mm
 Collet bore: 6 mm
 Weight: 0.8 kg

Order no.
627609000*



Flexible shaft 30980

- Suitable for speeds of 7,500 to 30,000 rpm
- Bearing-mounted at both ends
- For router bits, mounted points, flap wheels etc. with 8 mm shaft diameter. Interchangeable collet for accessories with 6 mm shaft diameter (630977000) and 3 mm shaft diameter (630976000) available as accessory
- 8 mm driving shaft for fixing the flexible shaft in the collet bore of the drive machine. If the collet bore of the drive machine has a different dimension than 8 mm, the collet of the drive machine must be changed. 6 mm collet available as accessory (631945000)

Suitable for routers: FME 737
 Suitable for die grinders: G 400, GE 710 Compact, GE 710 Plus, GE 950 G Plus, GA 18 LTX
 Length: 1.3 m
 Driving shaft: 8 mm
 Collet bore: 8 mm
 Weight: 0.8 kg

630980000*

* Self-service packaging

Collets for flexible shaft 630980000



- To attach the carbide router bits, mounted points etc. to the flexible shaft

Collet bore	Order no.
3 mm	630976000
6 mm	630977000
8 mm	630979000



Collets for flexible shaft 627609000



- To attach the carbide router bits, mounted points etc. to the flexible shaft

Collet bore	Order no.
3 mm	630715000
6 mm	630714000

Additional accessories for die grinders

	Order no.
 <p>Tensioning frame</p> <ul style="list-style-type: none"> ■ Tensioning frame for working with a flexible shaft ■ The Metabo tensioning frame with hard rubber can be set up or hung up, is non-slip, stable and protects delicate surfaces from scratches. ■ Suitable for G 400, GE 710 Plus, GE 950 G Plus, GA 18 LTX, GA 18 LTX G 	628329000
 <p>Clamping stand</p> <ul style="list-style-type: none"> ■ For safe clamping of drills and impact drills as well as die grinders and the motor of the router when working with flexible shafts. Aperture Ø 43 mm. The clamp (627107000) serves for the secure fixing 	627354000*
 <p>Clamp</p> <ul style="list-style-type: none"> ■ For the secure fixing on a work table 	627107000*

Accessories for angle polishers

Hook and loop backing pads



- With hook and loop, for attaching polishing and sanding accessories, maximum working speed: 80 m/s

Diameter mm	Thickness mm	Female thread	Max. speed rpm	Sales unit	Order no.
113	2	M 14	13.000	1	624840000*
123	12	M 14	12.000	1	623287000*
147	12	M 14	10.000	1	623288000*
173	12	M 14	8.500	1	623289000*
113	12	5/8 "	13.000	1	623272000*
173	12	5/8 "	8.500	1	623273000*

Hook and loop polishing sponges, coarse



- For polishing up weathered paintwork

Diameter mm	Thickness mm	Sales unit	Order no.
80	25	1	624912000*
130	25	1	624913000*
160	25	1	624915000*
160	50	1	624916000*

Hook and loop polishing sponges, fine



- For polishing paintwork

Diameter mm	Thickness mm	Sales unit	Order no.
80	20	1	624092000*
130	25	1	624967000*
130	50	1	624926000*
160	25	1	624968000*
160	50	1	624927000*

Hook and loop polishing felt, soft



- For polishing paintwork, non-ferrous metals, and steel sheets

Diameter mm	Thickness mm	Sales unit	Order no.
130	5	1	624964000*
155	5	1	624965000*

* Self-service packaging

* Self-service packaging

01
02
03
04
05
06
07
08
09
10
11
12
13
14
15
16

Hook and loop lambswool polishing discs



- For high-gloss polishing

Diameter mm	Sales unit	Order no.
85	1	624063000*
130	1	631223000*
150	1	631217000*

Lambswool polishing bonnets with tightening cord



- For high-gloss polishing

Diameter mm	Sales unit	Order no.
180	1	623265000*



Plastic disc brushes



- SiC grinding filaments, undulated, Ø 1.27 mm. For processing, deburring, grinding and structuring of surfaces. Suitable for steel, cast steel, NF-metals, wood, and plastics. Maximum working speed: 19 m/s, recommended speed: 1,200-1,900 min⁻¹

Diameter mm	Grit	Sales unit	Order no.
130	P 46	1	623740000
130	P 60	1	623741000
130	P 80	1	623742000

Additional accessories for polishers

	Order no.
 <p>Extension piece M 14/ M 14</p> <ul style="list-style-type: none"> ■ For working with the backing pads; increases the distance between the machine spindle and the backing pad by approximately 35 mm; with M 14 female thread and M 14 male thread 	631360000*
 <p>Arbor</p> <ul style="list-style-type: none"> ■ For 2 buffing mops with flanges and flange nut 	623107000*
 <p>Vienna lime chalk</p> <ul style="list-style-type: none"> ■ For cleaning, caring and polishing of smooth surfaces, especially stainless steel, silver, brass, glass, ceramic etc. ■ Contents: 300 g, shaker 	626399000

Accessories for wet polishers

Hook and loop backing pads



- With hook and loop and flexible middle section, foam-moulded, for application of flexible diamond hook and loop polishing discs. Sanding pad for polishing and curved polishing.
- Diameter 100 mm; thickness 12 mm; female thread M 14

626148000

*Self-service packaging

Accessories for metal chop saws

Quality class A 30-R »Flexiamant« steel



NEW

- For use in all steel processing applications
- Good cutting output with good tool life in steel
- Uniform in cutting output and tool life
- Medium-hard version for powerful machines (machine load > 3 KW)
- Maximum working speed 80 m/s

Quality class	Diameter x thickness x bore mm	Version	Maximum speed /min	Sales unit / packing unit	Order no.
A 30-R	355 x 3 x 25,4	—	4.365	1/10	616346000

Quality class A 30-R / A 36-S »Flexiamant Super« steel



- Good cutting output with good tool life in steel
- Hard version for powerful machines (machine load > 3 KW)
- A 36-S: with an inside gauze for quick cuts
- Maximum working speed 80 m/s

Quality class	Diameter x thickness x bore mm	Version	Maximum speed /min	Sales unit / packing unit	Order no.
A 30-R	350 x 3 x 25,4	—	4.365	1/10	616327000
A 36-S	350 x 3 x 25,4	—	4.365	1/10	616339000

Quality class A 24-M »Flexiamant Super« Steel



- High cutting output with good tool life in steel
- Soft version for less powerful machines (machine load <3 KW)
- Maximum working speed 80 m/s

Quality class	Diameter x thickness x bore mm	Version	Maximum speed /min	Sales unit / packing unit	Order no.
A 24-M	350 x 3 x 25,4	—	4.365	1/10	616338000

Quality class A 36-R »Flexiamant Super« Inox



- Medium-hard special cutting disc for stainless steel
- High cutting output with good tool life
- Low in iron and sulphur <0.1%
- Maximum working speed 80 m/s
- Medium-hard version for less powerful machines (machine load <3 KW)

Quality class	Diameter x thickness x bore mm	Version	Maximum speed /min	Sales unit / packing unit	Order no.
A 36-R	350 x 3 x 25,4	—	4.365	1/10	616343000

Accessories for bench grinders

Grinding wheels, aluminium oxide



- For sanding/grinding tool steel
- Fine grit (60N): suitable for fine grinding of hardened and unhardened steels, for example spiral drills, screwdrivers, chisels, turning chisels, splitting tools, bevelled-edge chisels, carving knives
- Coarse grit (36P): suitable for pre-grinding of hardened and unhardened steels, for example chisels, splitting tools

Diameter x thickness x bore mm	Grit and hardness	Suitable for	Order no.
120 x 20 x 20	36 P	DS 125, Ds W 3150	629088000
120 x 20 x 20	60 N	DS 125, Ds W 3150	629089000
120 x 20 x 12	60 N	DS 125 W, Ds W 3150	629090000
150 x 20 x 20	36 P	DS 150, Ds W 3150	630632000
150 x 20 x 20	60 N	DS 150, Ds W 3150	630633000
150 x 20 x 32	36 P	Ds 7202	630777000
150 x 20 x 32	60 N	Ds 7202, Ds 7203	630778000
175 x 25 x 20	36 P	DS 175 W / DS 175 D	629091000
175 x 25 x 20	60 N	DS 175 W / DS 175 D	629092000
175 x 25 x 32	36 P	DS 175, BS 175, TNS 175, Ds W 5175 / Ds D 6175	630657000
175 x 25 x 32	60 N	DS 175, BS 175, TNS 175, Ds W 5175 / Ds D 6175	630656000
200 x 25 x 20	36 P	DS 200/25 W / DS 200/25 D	629093000
200 x 25 x 20	60 N	DS 200/25 W / DS 200/25 D	629094000
200 x 25 x 32	36 P	DS 200, DSD 200, Ds 7211, Ds W 9200 / Ds D 9201	630784000
200 x 25 x 32	60 N	DS 200, DSD 200, Ds 7211, Ds W 9200 / Ds D 9201	630785000
200 x 32 x 32	36 P	Ds W 9200 / Ds D 9201	630634000
200 x 32 x 32	60 N	Ds W 9200 / Ds D 9201	630635000
250 x 32 x 32	24 Q	Ds 7226	630788000
250 x 32 x 32	60 N	Ds 7226	630789000
250 x 40 x 51	36 P	DSD 250, Ds D 9250	630636000
250 x 40 x 51	60 N	DSD 250, Ds D 9250	630637000

Pink aluminium oxide grinding wheels



- For sanding/grinding HSS tools

Diameter x thickness x bore mm	Grit and hardness	Suitable for	Order no.
150 x 20 x 20	80 J	Ds W 3150	630638000
150 x 50 x 13	80 I	Ds 7203	630779000

Silicone carbide grinding wheels



- Suitable for fine ground finish on hard metals and carbide-coated tools, grey cast iron, copper, aluminium, glass, ceramic

Diameter x thickness x bore mm	Grit and hardness	Suitable for	Order no.
120 x 20 x 20	80 J	DS 125	629102000
150 x 20 x 20	80 J	DS 150, Ds W 3150	629103000
175 x 25 x 20	80 J	DS 175 W / DS 175 D, TNS 175	629095000
175 x 25 x 32	80 J	DS 175, BS 175, TNS 175	629104000
200 x 25 x 20	80 J	DS 200/25 W / DS 200/25 D, TNS 175	629096000
200 x 25 x 32	80 J	DS 200, DSD 200, Ds W 9200 / Ds D 9201	629105000
250 x 40 x 51	80 J	DSD 250, Ds D 9250	629106000

Wet grinding wheels



- Suitable for fine grinding of unhardened steels, for example knives, bevelled-edge chisels, turning chisels, splitting tools, shears.

Diameter x thickness x bore mm	Grit and hardness	Suitable for	Order no.
150 x 30 x 20	220 K	TNS 150 W	629097000
200 x 40 x 20	220 K	TNS 175	629098000



Sanding belts



- High-quality sanding paper (aluminium oxide) with dense distribution, high removal of material and long durability. Universal use: For grinding and deburring metals, non-alloyed and low-alloyed steels, cast iron, aluminium alloys, brass, bronze, hard metal coatings, rubber, plastics etc.
- Recommended circumferential speed: 25-35 m/s

Dimensions mm	Grit	Sales unit	Order no.
50 x 650	P 60	3	629060000*
50 x 650	P 100	3	629061000*
50 x 650	P 150	3	629062000*
50 x 1.020	P 60	3	629063000*
50 x 1.020	P 80	3	629064000*
50 x 1.020	P 100	3	629065000*
50 x 1.020	P 120	3	629066000*
50 x 1.020	P 180	3	629067000*
50 x 1.020	P 240	3	629068000*
50 x 1.020	P 400	3	629069000*

Further accessories for bench grinders

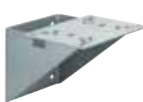

	Order no.
 <p>Dressing stick Dressing stick made of silicone carbide. For dressing grinding wheels; blunt grinding abrasives are removed.</p>	629099000
 <p>Stands Suitable for all Metabo bench grinders (from YOM 2005). With pull out container for cooling water or handy tool storage. A double vertical slit for storage of grinding wheels, tools etc. Height 835mm, dimension of plate: 200 x 280 mm; Ø-Base plate: 340 mm</p>	623867000
 <p>Wall panel Suitable for all Metabo bench grinders up to disc -Ø 200 mm (built after 2005), except BS 175, DS 250 D. Dimensions: 280 mm x 90 mm x 204 mm</p>	623862000

*Self-service packaging

Accessories for bevelling tools



Carbide indexable inserts for deburring and rounding

- For deburring of sheet metal with many contours
- For chamfering of pipes
- For chamfering and rounding of drilled and punched edges
- Suitable for KFM 9-3 RF, KFM 18 LTX 3 RF

	Order no.
 10 Carbide indexable inserts R2, radius 2	623561000
 10 Carbide indexable inserts R3, radius 3	623562000
 10 Carbide indexable inserts chamfer 45°	623560000

Carbide indexable inserts for weld seam preparation

- For weld seam preparation of flat material and pipes
- Suitable for KFM 15-10 F, KFM 16-15 F, KFMPB 15-10 F





	Order no.
 10 Carbide indexable inserts Universal For chamfering of production and in fine-grained steel, as well as stainless steel	623564000
 10 Carbide Indexable Inserts For chamfering stainless steel	623565000
 10 Carbide Indexable Inserts For chamfering aluminium and plastics	623559000

Fixing screws for indexable inserts

	Order no.
 <ul style="list-style-type: none"> ■ To fix the indexable inserts for the bevelling tools ■ The screws have a hexagon recess on the thread side so that the indexable inserts can also be exchanged with a damaged screw and the screws can be replaced. ■ Suitable for KFM 15-10 F, KFM 16-15 F, KFMPB 15-10 F, KFM 9-3 RF, KFM 18 LTX 3 RF 	623566000

Accessories for metal shears

Reversible blade



	Order no.
 2 Reversible blades for SCV 18 LTX ■ Reversible blade for high-strength sheets up to 800 N/mm ² NEW	630241000*
 2 Reversible blades for SCV 18 LTX ■ Reversible blade for sheets up to 400 N/mm ² NEW	630239000*
 Reversible blade for Ku 6870 ■ Same blade for tappet and cutting bench	630201000
 Reversible blade for Ku 6872 ■ Same blade for tappet and cutting bench	631042000

Tappet blade



	Order no.
 Tappet blade Suitable for Ku 6872 and Ku 6870	631041000

Accessories for nibblers

Punch

	Order no.
 NEW Punches for NIV18 LTX BL 1.6 <ul style="list-style-type: none"> ■ For processing sheet steel from 0.7 to 1.6 mm ■ For processing aluminium up to 2.0 mm sheet thickness 	630243000*
 Punch for Kn 6875 (as spare)	630202000

Dies

	Order no.
 NEW Die for NIV18 LTX BL 1.6 <ul style="list-style-type: none"> ■ For processing sheet steel from 0.7 to 1.6 mm ■ For processing aluminium up to 2.0 mm sheet thickness 	630247000*
 Die for Kn 6875 (as spare)	630203000

*Self-service packaging

Accessories for wall chasers

Diamond cutting discs



Diamond cutting discs »professional« / CP

- Powerful diamond cutting disc with segmented edge for aggressive, fast cutting of hard materials with very high cutting performance and very good tool life
- Particularly suited for all hard materials such as concrete (including reinforced), concrete pipes, kerbstones, hard sandstone, facing stones, exposed aggregate concrete thanks to special turbo segments
- Highest safety thanks to laser-welded diamond segments. Segment height 12 mm.

NEW

Diameter x bore mm	Segment dimensions mm	Number of segments	Maximum speed /min	Sales unit	Packaging	Order no.
125 x 22,23	33 x 2,4 x 12	9	12.200	1	Cardboard box	628571000*
230 x 22,23	42 x 2,6 x 12	15	6.600	1	Cardboard box	628574000*



Diamond cutting discs »professional« / UP

- Powerful diamond cutting disc with segmented edge for aggressive, fast cutting of hard materials with high cutting performance and very good tool life
- Particularly suited for general construction/building materials such as concrete, exposed aggregate concrete, hard and soft sandstones, clay tiles
- Clean cutting edges and high cutting speed thanks to special short teeth segments
- Highest safety thanks to laser-welded diamond segments. Segment height 9 mm.

NEW

Diameter x bore mm	Segment dimensions mm	Number of segments	Maximum speed /min	Sales unit	Packaging	Order no.
125 x 22,23	20 x 2,4 x 9	15	12.200	1	Cardboard box	628559000*
230 x 22,23	20 x 2,6 x 9	30	6.600	1	Cardboard box	628562000*

Diamond cutting discs

Our complete range of diamond cutting discs can be found in chapter 03 of this catalogue. We offer diamond cutting discs in all relevant diameters in different quality classes for all applications such as cutting of concrete, granite, tiles and other building materials.



Diamond cutting disc »professional« / UP-T

- Fast and comfortable cutting of wall slots in different materials possible
- Highly reduced workload thanks to the intelligent system of interlacing arrangement of segments, since chiseling away of the centre is not required. Great time saving thanks to cutting in one step
- Reduction of dirt and dust, since the material is removed cleanly and completely from the slot
- Customised slots for individual lines, or for Ø 20 and 25 mm-empty pipes. Max. cutting width: 20 mm (2 rows 628298000) / 30 mm (3 rows 628299000)

	Diameter x bore mm	Segment dimensions mm	Number of segments	Maximum speed /min	Sales unit	Packaging	Order no.
	125 x 22,23	18 x 7	20	12.200	1	Cardboard box	628298000*
	125 x 22,23	28,5 x 7	30	12.200	1	Cardboard box	628299000*

Further accessories for wall chasers

	Order no.
<p>Suction hose for MFE, Ø-35 mm</p> <ul style="list-style-type: none"> ■ When using a second suction hose, the dust extraction device can be placed at a distance of up to 8 m from the work area ■ With bayonet fitting for connection to the extraction nozzle of wall chasers MFE 30, MFX 65 and MFE 65 <p>Hose Length: 4 m Hose-Ø, internal: 33 mm Hose-Ø, internal: 40 mm Connection-Ø, internal: 58 mm Bayonet connection: yes Rotation compensation: both sides</p>	630344000
<p>Guide rail</p> <ul style="list-style-type: none"> ■ Guide rail made of sturdy, anodised aluminium extrusion ■ Anti-slip backing provides safe and reliable support and protects the work piece surface against scratches ■ Guide rule, adjustable to eliminate play <p>suitable for: Metabo jigsaws, circular saws and routers models OFE 738 and Of E 1229 Signal (when using the appropriate accessories; KS 55 FS, KSE 55 Vario Plus, KS 66 Plus, KSE 68 Plus can be used directly); also suitable for the CED 125 Plus dust extraction shroud in connection with an angle grinder Overall length: 1,500 mm</p>	631213000
<p>Coupling bush</p> <ul style="list-style-type: none"> ■ Particularly suited for coarse dirt, as well as tools with high generation of dust ■ Suitable for power tools with an extraction connection with outer diameter of 40 mm ■ Conducts electricity <p>Material: plastic External-Ø: 45 mm Internal-Ø: 40 mm</p>	630796000*

*Self-service packaging

Which machine and accessories for which application?

Areas of application		for small areas up to ~ 50 m ²			for medium areas up to ~ 100 m ²			for medium areas up to ~ 100 m ²		for small areas up to ~ 50 m ²		
Type		Renovation grinder RSEV 17-125			Renovation grinder RSEV 19-125 RT			Renovation milling machine RFEV 19-125 RT				
Accessories		Diamond cup wheel concrete "pro" Ø 125 mm	Diamond cup wheel abrasive "pro" Ø 125 mm	PCD cup wheel "pro" Ø 125 mm	Diamond cup wheel concrete "pro" Ø 125 mm	Diamond cup wheel abrasive "pro" Ø 125 mm	PCD cup wheel "pro" Ø 125 mm	Milling head flat tooth (complete) Ø 115 mm / M14	Milling head pointed tooth (complete) Ø 115 mm / M14	Diamond cup wheel concrete "pro" Ø 125 mm	Diamond cup wheel abrasive "pro" Ø 125 mm	PCD cup wheel "pro" Ø 125 mm
		Order no. 628205000	Order no. 628206000	Order no. 628208000	Order no. 628205000	Order no. 628206000	Order no. 628208000	Order no. 628219000	Order no. 628218000	Order no. 628205000	Order no. 628206000	Order no. 628208000
Concrete	Fresh concrete	<input type="checkbox"/>	<input checked="" type="checkbox"/>		<input type="checkbox"/>	<input checked="" type="checkbox"/>		<input type="checkbox"/>	<input type="checkbox"/>	<input type="checkbox"/>	<input type="checkbox"/>	
	Old concrete/ very hard concrete > B35	<input checked="" type="checkbox"/>	<input type="checkbox"/>		<input checked="" type="checkbox"/>	<input type="checkbox"/>				<input type="checkbox"/>	<input type="checkbox"/>	
Adhesive	Tile cement	<input type="checkbox"/>	<input checked="" type="checkbox"/>	<input type="checkbox"/>	<input type="checkbox"/>	<input checked="" type="checkbox"/>	<input type="checkbox"/>	<input type="checkbox"/>	<input checked="" type="checkbox"/>	<input type="checkbox"/>	<input checked="" type="checkbox"/>	<input type="checkbox"/>
	Elastic adhesive			<input checked="" type="checkbox"/>			<input checked="" type="checkbox"/>	<input type="checkbox"/>	<input checked="" type="checkbox"/>			<input checked="" type="checkbox"/>
Screed	Soft	<input type="checkbox"/>	<input checked="" type="checkbox"/>		<input type="checkbox"/>	<input checked="" type="checkbox"/>		<input checked="" type="checkbox"/>	<input checked="" type="checkbox"/>	<input type="checkbox"/>	<input type="checkbox"/>	
	Hard	<input checked="" type="checkbox"/>	<input type="checkbox"/>		<input checked="" type="checkbox"/>	<input type="checkbox"/>				<input type="checkbox"/>	<input type="checkbox"/>	
Plaster	Removal/cutting of hard cement plaster and / or (cement lime plaster) with high sand content	<input checked="" type="checkbox"/>	<input type="checkbox"/>	<input checked="" type="checkbox"/>	<input checked="" type="checkbox"/>	<input type="checkbox"/>	<input checked="" type="checkbox"/>	<input type="checkbox"/>	<input checked="" type="checkbox"/>	<input checked="" type="checkbox"/>	<input type="checkbox"/>	<input checked="" type="checkbox"/>
	Grinding / removal of hard cement plaster	<input checked="" type="checkbox"/>	<input type="checkbox"/>	<input type="checkbox"/>	<input checked="" type="checkbox"/>	<input type="checkbox"/>	<input type="checkbox"/>	<input type="checkbox"/>	<input checked="" type="checkbox"/>	<input checked="" type="checkbox"/>	<input type="checkbox"/>	<input type="checkbox"/>
	Grinding / removal of hard plaster (cement lime finishing plaster)	<input type="checkbox"/>	<input type="checkbox"/>	<input type="checkbox"/>	<input type="checkbox"/>	<input type="checkbox"/>	<input type="checkbox"/>	<input type="checkbox"/>	<input checked="" type="checkbox"/>	<input type="checkbox"/>	<input type="checkbox"/>	<input type="checkbox"/>
	Grinding / removal of synthetic resin plaster	<input type="checkbox"/>	<input type="checkbox"/>	<input checked="" type="checkbox"/>	<input type="checkbox"/>	<input type="checkbox"/>	<input checked="" type="checkbox"/>	<input type="checkbox"/>	<input checked="" type="checkbox"/>	<input type="checkbox"/>	<input type="checkbox"/>	<input checked="" type="checkbox"/>
	Grinding / removal of lime plaster, gypsum plaster	<input type="checkbox"/>	<input checked="" type="checkbox"/>	<input type="checkbox"/>	<input type="checkbox"/>	<input checked="" type="checkbox"/>	<input type="checkbox"/>	<input checked="" type="checkbox"/>	<input type="checkbox"/>	<input type="checkbox"/>	<input checked="" type="checkbox"/>	<input type="checkbox"/>
	Removal of gypsum filler	<input type="checkbox"/>	<input checked="" type="checkbox"/>	<input type="checkbox"/>	<input type="checkbox"/>	<input checked="" type="checkbox"/>	<input type="checkbox"/>	<input checked="" type="checkbox"/>	<input type="checkbox"/>	<input type="checkbox"/>	<input checked="" type="checkbox"/>	<input type="checkbox"/>
Colour / coating	Latex colours and oil colours	<input type="checkbox"/>		<input type="checkbox"/>	<input type="checkbox"/>		<input checked="" type="checkbox"/>	<input checked="" type="checkbox"/>	<input type="checkbox"/>	<input type="checkbox"/>		<input checked="" type="checkbox"/>
	Elastic protective coatings (concrete colour)	<input type="checkbox"/>		<input type="checkbox"/>	<input type="checkbox"/>		<input type="checkbox"/>	<input checked="" type="checkbox"/>	<input type="checkbox"/>	<input type="checkbox"/>		<input checked="" type="checkbox"/>
	Bitumen			<input type="checkbox"/>			<input checked="" type="checkbox"/>					<input checked="" type="checkbox"/>
	PU Polyurethane			<input type="checkbox"/>			<input checked="" type="checkbox"/>	<input type="checkbox"/>				<input checked="" type="checkbox"/>
	Epoxy	<input type="checkbox"/>		<input type="checkbox"/>	<input type="checkbox"/>		<input checked="" type="checkbox"/>	<input type="checkbox"/>	<input checked="" type="checkbox"/>	<input type="checkbox"/>		<input checked="" type="checkbox"/>
Natural stone / ceramic	Granite	<input checked="" type="checkbox"/>	<input type="checkbox"/>		<input checked="" type="checkbox"/>	<input type="checkbox"/>				<input type="checkbox"/>	<input type="checkbox"/>	
	Ceramic	<input checked="" type="checkbox"/>	<input type="checkbox"/>		<input checked="" type="checkbox"/>	<input type="checkbox"/>				<input type="checkbox"/>	<input type="checkbox"/>	
	Marble	<input type="checkbox"/>	<input checked="" type="checkbox"/>		<input type="checkbox"/>	<input checked="" type="checkbox"/>				<input type="checkbox"/>	<input type="checkbox"/>	

Very suitable Highly suitable

Accessories for renovation grinders

For hard materials, quality class concrete »professional«



- Particularly powerful diamond cup wheel
- Well suited for grinding of thick concrete layers, levelling of concrete and granite and other natural stones, removal of sludge skins and formwork seams on concrete, removal of hard cement, chalk-cement-plaster, hard screed
- Precise processing of edges without cracking
- Maximum working speed 80 m/s

Diameter x bore mm	Number of segments	Max. speed	Sales unit	Order no.
125 x 22,23	16	12.200	1	628205000*

For abrasive materials, quality class abrasive »professional«



- Particularly powerful diamond cup wheel
- Excellently suited for grinding of fresh concrete coatings, chalk and cement plaster, gypsum filler, levelling of fresh screed, removal of tile adhesive and processing of marble
- Maximum working speed 80 m/s

Diameter x bore mm	Number of segments	Max. speed	Sales unit	Order no.
125 x 22,23	16	12.200	1	628206000*

For protective concrete coatings, quality class »professional«



- Particularly powerful PCD special cup wheel
- Excellently suited for spot grinding and removal of elastic protective coatings, adhesives, sealants, removal of latex and oil paints, bitumen, PU/polyurethane, epoxy, elastic adhesive, for removal of lime plaster and gypsum plaster, abrading of resin plaster and hard cement plaster.
- Fast and effective removal without sticking due to PCD (poly-crystalline diamonds) segments
- Maximum working speed 80 m/s

Diameter x bore mm	Number of segments	Max. speed	Sales unit	Order no.
125 x 22,23	12	12.200	1	628208000*
150 x 22,23	15	10.200	1	NEW 628097000*

For hard materials, quality class concrete »classic«



- Powerful, double coated diamond cup wheel
- Well suited for grinding of thick concrete layers, levelling of concrete and granite and other natural stones, removal of sludge skins and formwork seams on concrete, removal of hard cement, chalk-cement-plaster, hard screed
- Maximum working speed 80 m/s

Diameter x bore mm	Number of segments	Max. speed	Sales unit	Order no.
125 x 22,23	20	12.200	1	628209000*

Replacement brush rim







- Replacement brush rim RS
- Suitable for RS 14-125, RS 17-125, RSEV 19-125 RT

Order no.
628214000*

*Self-service packaging

Accessories for renovation milling machines

Milling heads		Order no.
	Milling head pointed tooth complete <ul style="list-style-type: none"> ■ Milling head pointed tooth - contact face tipped with 10 carbide stars ■ For the removal of hard plaster, concrete, foam backing, adhesive remains, paint coatings on plaster, synthetic resin plaster, elastic protective coatings, plaster on beams and latex / oil paint on plaster ■ The subsurface is roughened by the pointed shape of the milling stars ■ Suitable for RFEV 19-125 RT 	628218000*
	Milling head flat tooth complete <ul style="list-style-type: none"> ■ Milling head flat tooth - contact face tipped with 10 carbide stars ■ For the removal of soft materials such as plaster, fresh ("green") concrete, foam backing and adhesive remains, soft PU coatings, paint coatings on plaster, plaster on wooden beams, latex / oil paint on plaster, formwork joints and concrete runs on fresh concrete areas ■ The subsurface becomes smooth thanks to the flat shape of the milling stars (pulling cut) ■ Suitable for RFEV 19-125 RT 	628219000*

Milling stars		Order no.
	10 Milling stars, pointed tooth <ul style="list-style-type: none"> ■ For retrofitting the milling head of the RF 14-115 RFEV 19-125 RT ■ With 5 micro-encapsulated screws for safe fixing 	628270000*
	10 Milling stars flat tooth <ul style="list-style-type: none"> ■ For retrofitting the milling head of the RF 14-115 RFEV 19-125 RT ■ With 5 micro-encapsulated screws for safe fixing 	628271000*

Replacement brush rim		Order no.
	Replacement brush rim RF <ul style="list-style-type: none"> ■ Suitable for RF 14-115/ RFEV 19-125 RT 	628215000*

SDS-max/SDS-plus: Quality classes

Metabo offers you three quality classes for drill bits and chisels: From simple applications, where a solid, robust quality drill bit is required, and applications with high demands, to extreme applications with highest demands for the tool used. This means: We have the right drill bit or chisel for you for any application.

»Classic«

Solid, robust and reliable. These characteristics perfectly describe »Classic« tools. »Classic« hammer drill bits have a carbide tip and a good tool life. The chisels of this class are characterised by high material quality and good material removal. They always provide good service for all standard applications.

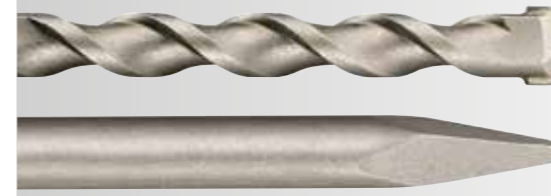

»Professional« / »Pro 4«

»Professional«, is, when it comes to drillers, in short "Pro4". Drill bits and chisels in this class are of particularly high quality and have a long service life. Special hardened steel and special surface handling guarantee long tool life and fast progress when drilling and chiselling. For users with high demands, who want more than the usual.



»Professional Premium« / »Pro 4 Premium«

This is the pinnacle of accessories. It offers the maximum of features a tool can offer. These products have innovative features that achieve excellent work results even for demanding applications. »Professional Premium« chisels are self-sharpening for maximum breaking performance and longest tool life. »Pro 4 Premium« drill bits with 4 cutting edges in 4x90° geometry do not stop even when hitting reinforced concrete. For users with high demands for tools and machines.



01

02

03

04

05

06

07

08

09

10

11

12

13

14

15

16

SDS-plus Hammer drill bits

SDS-plus »Pro 4«: progress extremely fast

The special cutting edge geometry on the chisel-shaped bit head made of high quality carbide ensures quick penetration even into the toughest concrete and granite.

- **Highest drill speed** thanks to reduction in friction and improved impact transmission
- **2-spiral helix with its large geometry with reinforced core (KVS).** The narrower cutting width geometry at the front edge and the reinforced relief and core at the rear additionally reduce friction whilst ensuring high resistance to breakage at the same time



- The **special cutting edge geometry** on the chisel-shaped drill head ensures deep penetration in hardest concrete and granite
- **Stable and durable centering point** for high-precision spot-drilling, no running across smooth surfaces



- **Power breakers** cause micro tears in the material for a noticeable quicker drill progress



SDS-plus »Pro 4 Premium«: break-proof and durable

The combination of an intelligent, innovative geometry with uncompromising quality right down to the last detail can be seen by the high level of durability, precise drilled holes and the extraordinarily quiet operation even under the toughest of conditions.

- **Innovative, unique, full carbide cutting edge geometry in optimum 4x90° symmetry** prevents catching when you come across reinforcements and ensures round holes
- **Power breakers** cause micro tears in the material for a noticeable quicker drill progress



- **up to Ø 12 mm: full carbide head** for even higher drill speed and longer service life



- **Ø 13-16 mm: single-piece carbide element** centering point for simple, accurate drilling



- **Ø from 18 mm: three-piece carbide element** centering point and wear marking on both sides of the main plate for simple, precise piloting and the evaluation of measured dowel holes





- **Low-vibration drilling with 4-spiral helix.** 2 large volume helixes remove the bore dust quickly and reliably from the drill hole, two reinforced spirals ensure additional safety and stability.



Carbide-tipped hammer drill bits, SDS plus »Classic«, 2 cutting edges



- SDS-plus drill bit with high-quality carbide drill tip
- Dynamic, chisel-shaped bit head
- Large-volume S-spiral geometry ensures quick drill dust removal
- Good drilling output with good tool life
- For use in concrete, masonry, natural stone

Diameter mm	Working length mm	Overall length mm	Sales unit	Order no.
5	50	110	1	626172000*
5	100	160	1	626173000*
6	50	110	1	626174000*
6	100	160	1	626175000*
6	150	210	1	626176000*
6	200	260	1	626177000*
6	250	310	1	626178000*
7	50	110	1	626179000*
7	100	160	1	626180000*
8	50	110	1	626181000*
8	100	160	1	626182000*
8	150	210	1	626183000*
8	200	260	1	626184000*
10	50	110	1	626185000*
10	100	160	1	626186000*
10	150	210	1	626187000*
10	200	260	1	626188000*
10	250	310	1	626189000*
10	400	450	1	626190000*
12	100	160	1	626191000*
12	150	210	1	626192000*
12	200	260	1	626193000*
12	250	310	1	626194000*
12	400	450	1	626195000*
14	100	160	1	626196000*
14	150	210	1	626197000*
14	250	310	1	626198000*
14	400	450	1	626199000*
	SDS-plus Classic drill bit set, 5 pieces in plastic storage case Ø 5, 6, 6, 8, 10 mm, L=160 mm			626243000*
	SDS-plus Classic drill bit set, 7 pieces in metal case Ø 5, 6, 6, 8, 10 mm, L=160 mm / Ø 6, 8, 10, 12 mm, L=160 mm			626244000*

Carbide-tipped hammer drill bit, SDS-plus »Pro 4«, 2 cutting edges







- Highest drill speed thanks to reduction in friction and improved impact transmission thanks to the special cutting geometry on the chisel-shaped drill head.
- Stable and durable centering point for high-precision spot-drilling
- Power breakers cause micro tears in the material for a noticeable quicker drill progress
- The probability of snagging on concrete reinforcements is significantly reduced thanks to enlarged armouring phases.
- The 2-spiral helix with its helical geometry with reinforced core ensures quick delivery of bore dust and maximum breakage resistance
- For use in concrete, masonry, natural stone, granite

Diameter mm	Working length mm	Overall length mm	Sales unit	Order no.
4	50	110	1	631780000*
4	100	160	1	625158000*
5	50	110	1	631820000*
5	100	160	1	631821000*
5	150	210	1	631864000*
5	200	260	1	625256000*
5	250	310	1	625257000*
5	310	360	1	625258000*

*Self-service packaging

Diameter mm	Working length mm	Overall length mm	Sales unit	Order no.
5	400	460	1	625259000*
5,5	50	110	1	631822000*
5,5	100	160	1	631823000*
5,5	200	260	1	625249000*
5,5	250	310	1	625250000*
6	50	110	1	631824000*
6	100	160	1	631825000*
6	150	210	1	631826000*
6	200	260	1	631866000*
6	250	310	1	NEW 625157000*
6	400	460	1	NEW 625156000*
6,5	50	110	1	631827000*
6,5	100	160	1	631828000*
6,5	150	210	1	631879000*
6,5	200	260	1	631876000*
6,5	250	310	1	631868000*
6,5	350	400	1	631785000*
6,5	390	450	1	NEW 625119000*
7	50	110	1	631829000*
7	100	160	1	631830000*
7	150	210	1	631831000*
8	50	110	1	631832000*
8	100	160	1	631833000*
8	150	210	1	631834000*
8	200	260	1	631835000*
8	250	310	1	625229000*
8	340	400	1	625251000*
8	400	460	1	631788000*
8	540	600	1	631789000*
9	150	210	1	631836000*
9,5	250	310	1	625253000*
10	50	110	1	631837000*
10	100	160	1	631838000*
10	150	210	1	631839000*
10	200	260	1	631840000*
10	250	310	1	631841000*
10	390	450	1	630519000*
10	540	600	1	631793000*
10	940	1.000	1	631794000*
11	110	160	1	631842000*
11	210	260	1	631843000*
12	110	160	1	631844000*
12	160	210	1	631845000*
12	210	260	1	631846000*
12	310	360	1	625254000*
12	400	450	1	630526000*
12	550	600	1	630527000*
12	950	1.000	1	631797000*
13	110	160	1	631847000*
13	210	260	1	631848000*
14	110	160	1	631849000*
14	160	210	1	631850000*
14	210	260	1	631851000*
14	260	310	1	631852000*
14	400	450	1	631801000*
14	550	600	1	630528000*
14	950	1.000	1	631802000*
15	100	160	1	NEW 625149000*
15	210	260	1	631853000*
15	410	450	1	631803000*
16	110	160	1	631854000*
16	160	210	1	631855000*
16	210	260	1	625255000*
16	260	310	1	631856000*

Diameter mm	Working length mm	Overall length mm	Sales unit	Order no.
16	400	450	1	630531000*
16	550	600	1	630532000*
16	750	800	1	631804000*
16	950	1.000	1	631805000*
18	150	200	1	630533000*
18	250	300	1	631806000*
18	400	450	1	630589000*
18	550	600	1	631807000*
18	950	1.000	1	631808000*
20	150	200	1	630536000*
20	250	300	1	630590000*
20	400	450	1	630537000*
20	550	600	1	631809000*
20	950	1.000	1	631810000*
22	200	250	1	630538000*
22	400	450	1	630539000*
22	550	600	1	631811000*
22	950	1.000	1	631812000*
24	200	250	1	630540000*
24	400	450	1	630541000*
25	200	250	1	631814000*
25	400	450	1	630549000*
25	550	600	1	631815000*
25	950	1.000	1	631816000*
26	200	250	1	630542000*
26	400	450	1	630548000*
4	50	110	10	625230000*
4	100	160	10	NEW 625118000*
5	50	110	10	625231000*
5	100	160	10	625232000*
6	50	110	10	625233000*
6	100	160	10	625234000*
6	150	210	10	625235000*
6,5	100	160	10	NEW 625116000*
6,5	150	210	10	NEW 625069000*
6,5	200	260	10	NEW 625068000*
8	50	110	10	625236000*
8	100	160	10	625237000*
8	150	210	10	625238000*
8	200	260	10	NEW 625117000*
10	50	110	10	625239000*
10	100	160	10	625240000*
10	150	210	10	625241000*
10	200	260	10	625242000*
12	110	160	10	625243000*
12	160	210	10	625244000*
12	210	260	10	625245000*
14	110	160	10	625246000*
14	160	210	10	625247000*
14	210	260	10	625248000*
14	210	260	10	630580000*
 SDS-plus Pro 4 drill bit set, 4 pieces in plastic storage case Ø 5, 6 mm, L = 50/110 mm; Ø 8,10 mm, L = 110/160 mm				
 SDS-plus Pro 4 drill bit set, 5 pieces in plastic storage case Ø 5, 6, 6, 8, 10 mm, L = 160 mm				
 SDS-plus Pro 4 drill bit set, 7 pieces in metal case Ø 5, 6, 6, 8, 8, 10, 12 mm, L = 110/160 mm				
 SDS-plus drill bit / chisel set, 5 pieces comprises each 1 hammer drill bit Ø 6, 8, 10 mm, 1 pointed chisel and 1 flat chisel				
 SDS-plus Pro 4 drill bits / chisel roll-up case, 10 pieces, set in roll-up case 2 x each: Ø 6 x 160; Ø 8 x 160; each 1 x: Ø 8 x 210; Ø 10 x 160; Ø 10 x 210; Ø 12 x 210 mm 1 x pointed chisel (L 200 mm), 1 x flat chisel (20 x 200 mm), incl. 1 x multi-tool				

*Self-service packaging

Carbide-tipped hammer drill bits (ice drill) with SDS-plus shank end, 2 cutting edges



- For use in ice and snow
- Suitable for easy installation of slalom posts.
- Special helix for ice and snow.

Diameter mm	Working length mm	Overall length mm	Sales unit	Order no.
32	400	450	1	630579000*

Carbide-tipped hammer drill bit, SDS-plus »Pro 4 Premium«, 4 cutting edges



- Intelligent geometry with its uncompromised quality of detail ensures a long service life, precise drill holes and maximum quiet running - even on the toughest loads.
- Highest level of safety thanks to the optimum symmetrical head geometry with 4 full carbide cutters, which do not catch when encountering reinforcing.
- Up to Ø 12 mm: with innovative, welded full carbide head for maximum tool life and larger dust outputs for highest drill speed
- Power breakers cause micro tears in the material for a noticeable quicker drill progress
- Low-vibration drilling with 4-spiral helix. 2 large volume helixes remove the bore dust quickly and reliably from the drill hole, two reinforced spirals ensure additional safety and stability.
- Extremely resistant to breakage thanks to high-grade special steel
- Very long tool life for up to 50% more dowel-compatible circular bores
- For professional use in masonry, concrete and armoured concrete

Diameter mm	Working length mm	Overall length mm	Sales unit	Order no.
5	50	115	1	626200000*
5	100	165	1	626201000*
5	150	215	1	626241000*
5,5	50	115	1	626202000*
5,5	100	165	1	626203000*
6	50	115	1	626204000*
6	100	165	1	626205000*
6	150	215	1	626206000*
6	200	265	1	626207000*
6	250	315	1	626208000*
6,5	100	165	1	626209000*
6,5	150	215	1	626210000*
6,5	200	265	1	626211000*
6,5	250	315	1	626212000*
6,5	400	465	1	NEW 626165000*
7	50	115	1	626213000*
7	100	165	1	626214000*
8	50	115	1	626215000*
8	100	165	1	626216000*
8	150	215	1	626217000*
8	200	265	1	626218000*
8	250	315	1	626237000*
8	400	465	1	626240000*
10	50	115	1	626219000*
10	100	165	1	626220000*
10	150	215	1	626221000*
10	200	265	1	626222000*
10	250	315	1	626223000*
10	390	455	1	626224000*
10	540	600	1	626117000*
12	100	165	1	626225000*
12	150	215	1	626226000*
12	200	265	1	626227000*
12	250	315	1	626228000*
12	400	455	1	626229000*
12	540	600	1	626118000*

Diameter mm	Working length mm	Overall length mm	Sales unit	Order no.
13	260	310	1	626124000*
14	110	160	1	626230000*
14	160	210	1	626231000*
14	210	260	1	626119000*
14	260	310	1	626232000*
14	400	450	1	626233000*
14	550	600	1	626120000*
15	160	210	1	626248000*
15	210	260	1	626121000*
16	110	160	1	626234000*
16	160	210	1	626235000*
16	210	260	1	626238000*
16	260	310	1	626236000*
16	400	450	1	626239000*
18	200	250	1	631703000*
18	400	450	1	631704000*
20	200	250	1	631705000*
20	400	450	1	631706000*
22	200	250	1	626122000*
22	400	450	1	631707000*
24	200	250	1	631708000*
24	400	450	1	631709000*
25	200	250	1	626123000*
25	400	450	1	631710000*
28	400	450	1	631711000*
30	400	450	1	631712000*
32	400	450	1	631713000*
5	50	115	10	626268000*
5	110	165	10	626269000*
6	50	115	10	626270000*
6	110	165	10	626271000*
6	150	215	10	626272000*
6	200	265	10	NEW 626247000*
6,5	165	215	10	NEW 626125000*
6,5	215	265	10	NEW 626126000*
6,5	315	265	10	NEW 626127000*
8	110	165	10	626273000*
8	150	215	10	626274000*
8	200	265	10	NEW 626128000*
10	110	165	10	626275000*
10	150	215	10	626276000*
12	100	165	10	626277000*
12	150	215	10	626278000*
12	200	265	10	626249000*



SDS-plus Pro 4 Premium drill bit set, 7 pieces
in robust plastic storage case
Ø 5 x 115 mm; 6 x 115 mm; 8 x 115 mm; 6 x 165 mm; 8 x 165 mm; 10 x 165 mm; 12 x 160 mm



SDS-plus Pro 4 Premium drill bit set, 7 pieces
Ø 5 x 160 mm; 6 x 210 mm; 6,5 x 210 mm; 6,5 x 260 mm; 8 x 260 mm; 10 x 260 mm; 12 x 260 mm



Accessory sets can be found in chapter 31, from page 288

*Self-service packaging

SDS-max »Pro 4« hammer drill bit

SDS-max »Pro 4«: Extremely fast in concrete

The extremely robust and aggressive full-carbide S-blade and suitable side cutters permit very fast drilling.

- Short head with **large-volume dust channels** for smooth transport of the drill dust, minimum generation of heat for constantly **long service life**

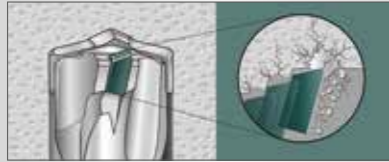

- Inclined auxiliary cutting edges for aggressive drilling progress with **highest drilling speed**

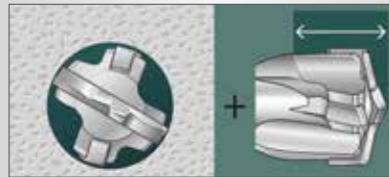

- Drill-active centering point** for precise spot-drilling and optimum guidance when drilling in concrete and reinforced concrete

- Innovative wear indication** as indicator for dimensional conformance and precise drilling hole diameter

- Vibration Control** – ideal for the hardest applications on the construction site

SDS-max »Pro 4« Premium: Highest drilling speed, longest service life

The extraordinarily strong and durable connection between steel body and the full-carbide drill head with 4 cutting edges guarantees extraordinarily high performance and tool life when drilling into reinforced concrete.

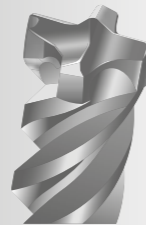

- Blade geometry - 90° centering point for precise spot drilling and little breakage at the edge of the drilled hole

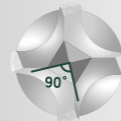

- Fast dust removal, best possible drilling progress thanks to optimal removal of the drill meal via four real helixes



- Marking/wear indication:** The visibility of the marking line indicates the precision of the drill diameter

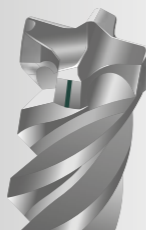

Carbide-tipped hammer drill bit, SDS-max »Classic«, 4 cutting edges



NEW

- SDS-max drill bit with high-quality carbide drill tip
- 4 blades, vacuum-soldered and hardened for long service life
- Good drilling output with good tool life
- Large-volume S-spiral geometry ensures quick drill dust removal
- For use in concrete, masonry, natural stone

Diameter mm	Working length mm	Overall length mm	Sales unit	Order no.
16	195	340	1	623116000*
16	395	540	1	623117000*
18	195	340	1	623118000*
18	395	540	1	623119000*
20	195	340	1	623120000*
20	395	540	1	623121000*
22	215	340	1	623122000*
22	415	540	1	623123000*
24	415	540	1	623124000*
25	415	540	1	623125000*
28	440	570	1	623128000*
30	440	570	1	623129000*
32	440	570	1	623130000*
35	435	570	1	623131000*
40	435	570	1	623132000*

Carbide-tipped hammer drill bit, SDS-max »Pro 4«, 2 cutting edges



- The slim, chisel-shaped bit head enables fast penetration into the selected material.
- Short spiral inlets and large boring dust grooves in the optimised double delivery helix ensure quick boring dust discharge.
- The continuous core reinforcement ensures stability and durability. It enables maximum energy transmission from rotary hammer to drill tip.
- For use in concrete, masonry, natural stone

Diameter mm	Working length mm	Overall length mm	Sales unit	Order no.
12	200	340	1	623310000*
12	400	540	1	623311000*
12	600	740	1	623312000*
14	200	340	1	623313000*
14	400	540	1	623314000*
15	200	340	1	623315000*
15	400	540	1	623316000*

Carbide-tipped hammer drill bit, SDS-max »Pro 4«, 4 cutting edges



- Unrivalled destructive force: Extremely robust and aggressive solid carbide S-blade
- Constant high lifetime: Short head with large-volume dust channels for smooth transport of the drill dust, minimum generation of heat
- Highest drilling speed: Inclined auxiliary cutting edges for aggressive drill progress
- Optimum centring: Drill-active centering point for optimum guidance when drilling in concrete and armoured concrete
- Precise drilling hole diameters: innovative wear indication (indicator for dimensional conformance)
- Vibration Control: optimised vibration values - ideal for the hardest applications on the construction site
- For use in concrete, masonry, natural stone

Diameter mm	Working length mm	Overall length mm	Sales unit	Order no.
16	200	340	1	623317000*
16	400	540	1	623318000*
16	1.200	1.320	1	623823000* NEW

*Self-service packaging

Diameter mm	Working length mm	Overall length mm	Sales unit	Order no.
18	200	340	1	623319000*
18	400	540	1	623320000*
18	1.200	1.320	1	NEW 623824000*
20	200	320	1	623321000*
20	400	520	1	623322000*
20	800	920	1	623323000*
20	1.200	1.320	1	NEW 623825000*
22	200	320	1	623324000*
22	400	520	1	623325000*
22	800	920	1	623326000*
22	1.200	1.320	1	NEW 623826000*
24	200	320	1	623327000*
24	400	520	1	623328000*
25	200	320	1	623329000*
25	400	520	1	623330000*
25	800	920	1	623331000*
25	1.200	1.320	1	NEW 623827000*
28	400	520	1	623333000*
28	600	720	1	623334000*
28	1.200	1.320	1	NEW 623828000*
30	400	520	1	623339000*
32	200	320	1	623340000*
32	400	520	1	623341000*
32	800	920	1	623342000*
32	1.200	1.320	1	NEW 623829000*
35	400	520	1	623344000*
35	600	720	1	623345000*
35	1.200	1.320	1	NEW 623830000*
38	400	520	1	623347000*
40	400	520	1	623349000*
40	600	720	1	623350000*
40	1.200	1.320	1	NEW 623831000*
45	400	520	1	623337000*
52	400	520	1	623338000*

Diameter mm	Working length mm	Overall length mm	Sales unit	Order no.
20	400	520	1	623233000*
20	600	720	1	623235000*
20	800	920	1	623236000*
22	200	320	1	623237000*
22	400	520	1	623238000*
22	600	720	1	623239000*
22	800	920	1	623240000*
24	200	320	1	623241000*
24	400	520	1	623242000*
25	200	320	1	623243000*
25	400	520	1	623245000*
25	800	920	1	623249000*
26	400	520	1	623252000*
28	200	320	1	623253000*
28	400	520	1	623255000*
28	800	920	1	623256000*
30	200	320	1	623217000*
30	400	520	1	623257000*
32	200	320	1	623263000*
32	400	520	1	623264000*
32	800	920	1	623268000*

Carbide hammer drill bit, SDS-plus »Pro 4 Premium«, 4 cutting edges



NEW

- Extremely robust and aggressive full carbide bit head, 4 cutting edges for extraordinary service life and tool life in strong concrete
- The wear marking on both sides of the main plate serves as indicator to evaluate the dimensional conformance of the dowel holes.
- The 4-spiral helical geometry ensures low-vibration drilling behaviour and low spiral wear
- 90° centering point for precise spot drilling and little breakage at the edge of the drilled hole
- Ideal for use in reinforced concrete and hard natural stone

Diameter mm	Working length mm	Overall length mm	Sales unit	Order no.
12	200	340	1	623193000*
12	400	540	1	623194000*
12	800	940	1	623211000*
14	200	340	1	623212000*
14	400	540	1	623213000*
14	800	940	1	623214000*
16	200	340	1	623215000*
16	400	540	1	623216000*
16	600	740	1	623218000*
16	800	940	1	623219000*
18	200	340	1	623228000*
18	400	540	1	623229000*
18	600	740	1	623230000*
18	800	940	1	623231000*
20	200	320	1	623232000*

*Self-service packaging

01
02
03
04
05
06
07
08
09
10
11
12
13
14
15
16

SDS-plus / SDS-max dust extraction drill bits



- **Drilling and cleaning in one work step** reduces the dust exposure and reworking
- **Greatest reinforcement compatibility**, no sagging or clogging thanks to 4-blade-geometry with extra large dust outlets
- **Noticeably fast drilling progress** thanks to optimal drill dust removal
- **Innovative head design** with greatest concentricity for precise dowel holes



- **Active drill bit cooling** for long service life
- **Dust-free drilling** for compliance with legal provisions on user safety. Up to 98% less dust in the bore
- **Universal vacuum cleaner adapter** fits all standard industrial M-class and H-class vacuum cleaners

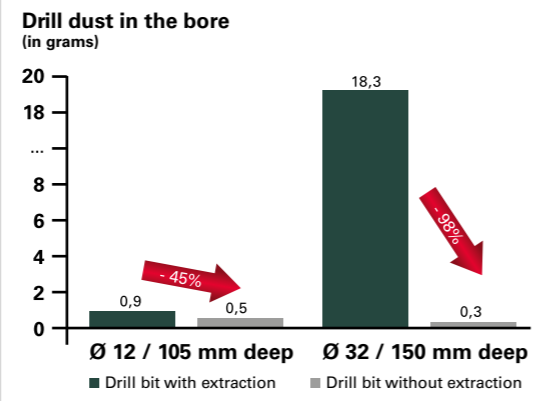

Kindly observe the installation instructions of the manufacturer when using the chemical installations

SDS-plus and SDS-max dust extraction drill bits

Carbide dust extraction drill bit, SDS-plus

	Diameter mm	Working length mm	Overall length mm	Sales unit	Order no.
					
	12	200	325	1	626902000*
	14	240	360	1	626903000*
	16	240	360	1	626904000*
	18	240	360	1	626905000*

- Drilling and cleaning in one work step reduces dust exposure and reworking
- Greatest reinforcement compatibility, no sagging or clogging thanks to 4-blade-geometry with extra large dust outlets
- Noticeably fast drilling progress thanks to optimal drill dust removal
- Innovative head design with greatest concentricity for precise dowel holes
- Active drill bit cooling for long service life
- Dust-free drilling for compliance with legal provisions on user safety. Up to 98% less dust in the bore
- Universal vacuum cleaner adapter fits all standard industrial M and H class vacuum cleaners

Kindly observe the installation instructions of the manufacturer when using the chemical installations



Carbide dust extraction drill bit, SDS-max

	Diameter mm	Working length mm	Overall length mm	Sales unit	Order no.
					
	16	400	600	1	626911000*
	18	400	600	1	626912000*
	20	400	600	1	626913000*
	22	400	600	1	626914000*
	24	400	600	1	626915000*
	25	400	600	1	626916000*
	28	400	600	1	626917000*
	28	700	900	1	626918000*
	30	400	600	1	626919000*
	30	700	900	1	626920000*
	32	400	600	1	626921000*
	32	700	900	1	626922000*
	35	400	600	1	626923000*
	35	700	900	1	626924000*

- Drilling and cleaning in one work step reduces dust exposure and reworking
- Greatest reinforcement compatibility, no sagging or clogging thanks to 4-blade-geometry with extra large dust outlets
- Noticeably fast drilling progress thanks to optimal drill dust removal
- Innovative head design with greatest concentricity for precise dowel holes
- Active drill bit cooling for long service life
- Dust-free drilling for compliance with legal provisions on user safety. Up to 98% less dust in the bore
- Universal vacuum cleaner adapter fits all standard industrial M and H class vacuum cleaners

Kindly observe the installation instructions of the manufacturer when using the chemical installations

Replacement adapter for dust extraction drill bit

	Replacement adapter for SDS-plus dust extraction drill bit Adapter for use with the SDS-plus dust extraction drill bits	626925000
NEW		
	Replacement adapter for SDS-max dust extraction drill bit Adapter for use with SDS-max dust extraction drill bits	626926000
NEW		

*Self-service packaging

Chisel SDS-plus / SDS-max

Chisels »professional«

Longest service life and versatility

- Use of high-grade heat-treated steel
- Special processing and hardening procedure, also suitable for re-sharpening
- Extensive range with chisels for many special applications such as channel chisels or stake drivers

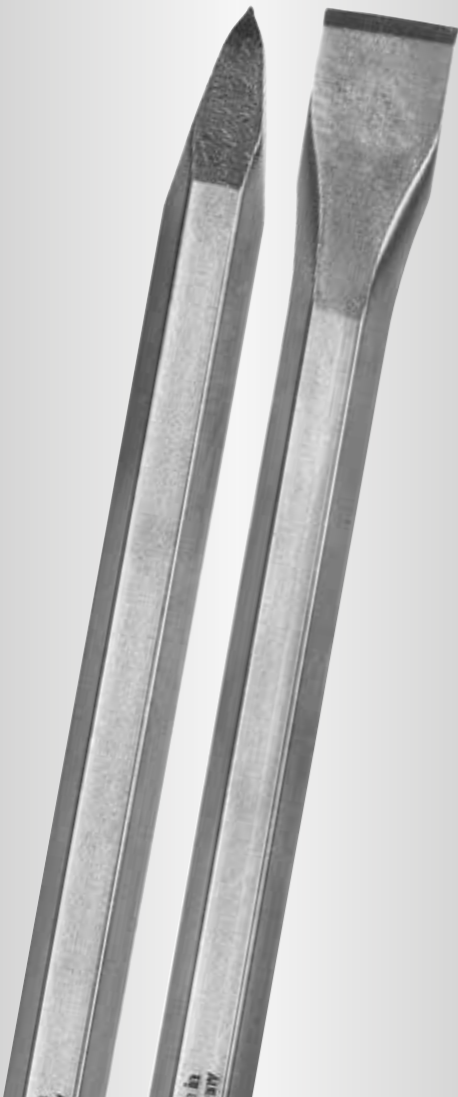

Chisels »professional premium«

Maximum service life and material removal

- Self-sharpening cutting edges for highest breaking performance
- Maximum removal thanks to efficient impact transmission and additional cutting edges
- The innovative head shape reliably prevents wedging
- Special hardened steel and special surface handling ensure longest tool life and productive operation.



Chisel, SDS-plus »classic«

- Robust, hardened tools with high material quality
- Good cutting output with good tool life

	Chisel shape	Overall length mm	Cutting width	Sales unit	Order no.
	Pointed chisel	250		1	628406000*
	Flat chisel	250	20	1	628407000*
	Scaling chisel	250	40	1	628408000*
	SDS-plus chisel bit set »classic«, 3 pieces comprising each 1 pointed chisel, 1 flat chisel and 1 scaling chisel				628412000*

NEW

Chisel, SDS-plus »professional«

- Special hardened steel and special surface treatment ensure a long tool life and productive operation
- For use in concrete, masonry, natural stone

	Chisel shape	Overall length mm	Cutting width	Sales unit	Order no.
	Pointed chisel, round tip	250		1	630992000*
	Pointed chisel, square tip	250		1	631421000*
	Pointed chisel, square tip	250		10	631387000
	Flat chisel	250	20	1	631420000*
	Flat chisel	250	20	10	631388000
	Scaling chisel	250	40	1	631425000*
	Tile chisel, offset	165	75	1	631449000*
	Tile chisel, offset	250	40	1	631456000*
	Chasing gouge	250	22	1	631422000*
	Mortar chisel, carbide-tipped	200		1	631424000*
	SDS-plus chisel set , 3 pieces comprising each 1 pointed chisel, 1 flat chisel and 1 scaling chisel				630478000
	SDS-plus chisel set , 5 pieces comprising each 2 pointed chisels, 2 flat chisels and 1 scaling chisel				630484000

Chisel, SDS-plus »professional premium«





- Self-sharpening cutting edges for highest breaking performance
- Maximum removal thanks to efficient impact transmission and additional cutting edges
- The innovative head shape reliably prevents wedging
- Special hardened steel and special surface handling ensure longest tool life and productive operation.

	Chisel shape	Overall length mm	Cutting width	Sales unit	Order no.
	Pointed chisel	250		1	629178000*
	Flat chisel	250	20	1	629179000*

*Self-service packaging

Chisel, SDS-max »classic«























- Robust, hardened tools with high material quality
- Good cutting output with good tool life

	Chisel shape	Overall length mm	Cutting width	Sales unit	Order no.
	Pointed chisel	400		1	628409000*
	Flat chisel	400	25	1	628410000*
	Sealing chisel	400	50	1	628411000*
	SDS-max chisel set, »classic«, 3 pieces comprising each 1 pointed chisel, 1 flat chisel and 1 scaling chisel				628413000*

NEW

Chisel, SDS-max »professional«

- Special hardened steel and special surface handling ensure long tool life and productive operation.

	Chisel shape	Overall length mm	Cutting width	Sales unit	Order no.
	Pointed chisel, round tip	280		1	623351000*
	Pointed chisel, round tip	400		1	623352000*
	Pointed chisel, round tip	400		10	623463000
	Pointed chisel, round tip	600		1	623358000*
	Flat chisel	280	25	1	623353000*
	Flat chisel	400	25	1	623354000*
	Flat chisel	400	25	10	623464000
	Flat chisel	600	25	1	623359000*
	Sealing chisel	400	50	1	623355000*
	Sealing chisel	300	80	1	623356000*
	Sealing chisel	350	115	1	623366000*
	Chasing gouge	300	26	1	623357000*
	Channel chisel	300	32	1	623365000*
	Tile chisel, offset	400	50	1	623367000*
	Toothed chisel	300	32	1	623368000*
	Mortar chisel	300	10	1	623369000
	Spade chisel	400	110	1	623383000
	Asphalt cutter	400	90	1	623384000
	Gouge chisel	380	35	1	623385000
	Stake driver	260	16,5	1	623386000*
	Stake driver	260	13	1	623387000*
	SDS-max chisel set, 5 pieces comprising each 2 pointed chisels, 2 flat chisels and 1 scaling chisel				630488000
	SDS-max chisel set, 5 pieces comprising 3 pointed chisels, 2 flat chisels				630489000



Accessory sets can be found in chapter 31, from page 288

Chisel, SDS-max »professional premium«

- Self-sharpening cutting edges for highest breaking performance
- Maximum removal thanks to efficient impact transmission and additional cutting edges
- The innovative head shape reliably prevents wedging
- Special hardened steel and special surface handling ensure longest tool life and productive operation.

	Chisel shape	Overall length mm	Cutting width	Sales unit	Order no.
	Pointed chisel	400		1	629180000*
	Flat chisel	400	25	1	629181000*

SDS-max concrete core cutters

Carbide-tipped concrete core cutters (single piece) with SDS-max shank bit



- Optimised pilot drill with 3 cutting edges for greatest compatibility with reinforcements
- Conically designed shank for optimum power transmission and low-vibration drilling
- 3 large spirals for fast drilling progress and faster dust discharge
- Ideal for drilling into hard materials.

Diameter mm	Overall length mm	Order no.
45	550	623375000*
45	990	623376000*
55	550	623377000*
55	990	623378000*
65	550	623379000*
65	990	623380000*
80	550	623381000*
80	990	623382000*

Core bits



Carbide core bits with ratio thread



- Sturdy universal tool for hard work in concrete and other building materials

Diameter mm	Working length mm	Order no.
50	100	623034000*
68	100	623035000*
80	100	623036000*
100	100	623032000*
125	100	623031000*

Carbide pilot drills with ratio thread

	Order no.
 Pilot drill 12 x 155 mm ■ For working with the carbide core bits with ratio thread Diameter: 12 mm	623038000
 Connector ■ Connector with ratio female thread and SDS-max shank end, length 195 mm, for the arbor 623299000 of concrete core bits and for mounting core bits with the help of the pilot drill 623038000	623370000*

*Self-service packaging

Arbor for carbide concrete core bits with ratio thread

Overall length mm	Order no.
280	623299000*

Carbide core bits with M 16 female thread



- Optimised with larger carbide teeth for longer tool life. Higher power efficiency due to stable, thin-walled bit body.
- For concrete, masonry, natural stone and limestone

Diameter mm	Working length mm	Order no.
30	55	623391000*
35	55	623392000*
40	55	623393000*
50	55	623394000*
68	55	623395000*
82	55	623396000*
100	55	623398000*
112	55	623399000*

Arbors with M16 male thread

- Set with Allen key for locking the pilot drill 627040000.
- For impact operation with light core cutters
- Also suitable for use with "Pioneer" universal hole saws.

Arbor	Order no.
Arbor Shaft type: SDS plus Overall length: 105 mm	627043000*
Arbor Shaft type: SDS plus Overall length: 220 mm	627042000*
NEW Arbor Shaft type: SDS plus Overall length: 370 mm	625224000*
Arbor Shaft type: SW11 Overall length: 90 mm	627041000*

Pilot drill, carbide-tipped

Pilot drill	Order no.
■ For work with the carbide core cutters (M16 female thread) and the universal hole saws "Pionier" (M16 female thread) in combination with one of the arbors Diameter: 8 mm Overall length: 120 mm	627040000*

Diamond socket countersink

For general building materials, quality class »professional«



- Ideal for all hard materials, general construction/building site materials such as concrete, exposed aggregate concrete, sand-lime brick, bricks, masonry.
- Segment height: 5.0 mm
- For drilling without impact
- M16 female thread

Diameter mm	Segment height mm	Sales unit	Order no.
68	5	1	628095000
82	5	1	628096000

Pilot drill, carbide-tipped

Pilot drill	Order no.
■ For work with the diamond socket countersinks (M16 female thread) in combination with one of the arbors Diameter: 8 mm Overall length: 130 mm	628207000*

Integral chucks for rotary hammers











Hammer chuck with adapter





Hammer chuck with adapter	Order no.
SDS-plus hammer chuck ■ For tools with SDS-plus shank end ■ Suitable for UHE 22, UHE 28 Multi, BHE 24, BHE 26, KHE 26 Contact, KHE 28	631920000*
SDS-plus hammer chuck ■ For tools with SDS-plus shank end ■ Suitable for KHE 32	631922000*
SDS-plus hammer chuck ■ For tools with SDS-plus shank end ■ Suitable for: UHE 2250/2650/ KHE 2650/2850/2851	631928000*
SDS-plus hammer chuck ■ For tools with SDS-plus shank end ■ Suitable for UHE 28 Plus, KHE 28 Plus	631931000*
SDS-plus hammer chuck ■ For tools with SDS-plus shank end ■ Suitable for KHE 2660 Quick, KHE 2860 Quick, UHE 2660-2 Quick, UHEV 2860-2 Quick, KHE 3251, KHA 36 LTX, KHA 36-18 LTX 32, KHA 18 LTX BL 24	631943000*

Chucks with adapter

Chucks with adapter	Order no.
Geared chucks with adapter ■ For tools with cylindrical shank end ■ Suitable for UHE 22, UHE 28 Multi, BHE 24, BHE 26, KHE 26 Contact, KHE 28 Chuck capacity: 1 - 13 mm	631924000*
Keyless chuck with adapter ■ For tools with cylindrical shank end ■ Suitable for UHE 22, UHE 28 Multi, BHE 24, BHE 26, KHE 26 Contact, KHE 28 Chuck capacity: 1.5 - 13 mm	631921000*
Keyless chuck with adapter ■ For tools with cylindrical shank end ■ Suitable for UHE 28 Plus, KHE 28 Plus Chuck capacity: 1.5 - 13 mm	631930000*
Keyless chuck with adapter ■ For tools with cylindrical shank end ■ Suitable for KHE 32 Chuck capacity: 1 - 13 mm	631923000*
Keyless chuck with adapter ■ For tools with cylindrical shank end ■ Suitable for UHE 2250/2850, KHE 2650/2851 Chuck capacity: 1.5 - 13 mm	631927000*
Keyless chuck with adapter ■ For tools with cylindrical shank end ■ Suitable for KHE 2660 Quick, KHE 2860 Quick, UHE 2660-2 Quick, UHEV 2860-2 Quick, KHE 3251, KHA 36 LTX, KHA 36-18 LTX 32, KHA 18 LTX BL 24 Chuck capacity: 1.5 - 13 mm	631968000*

*Self-service packaging

more accessories		Order no.
	Connector ■ With thread 1/2"-20 UNF. Holder: SDS-plus, 1/2"- 20 UNF	630928000*
	Connector ■ With 1/2"-20 UNF thread for chuck and hexagon recess 1/4" (6.35 mm) for screwdriver bits with bit retaining bush Holder: SDS-plus, 1/2"- 20 UNF	631285000*
	Bit retaining bush for connector 631285000 For fitting bits and sockets with 1/4" (6.35 mm) hexagon in the spindle of drills and impact drills with spindle thread 1/2"-20 UNF and hexagon recess 1/4" (6.35 mm). Also suitable for connectors 630928000 and 631285000.	631281000*
	Connector ■ Connector from SDS-max to SDS-plus to enable use of SDS-plus drill bits/chisels Holder: SDS-max, SDS-plus	623371000*
	Connector ■ Connector with ratio female thread and SDS-max shank end, length 195 mm, for the arbor 623299000 of concrete core bits and for mounting core bits with the help of the pilot drill 623038000 Holder: SDS-max, ratio female thread	623370000*
	Extraction set ESA for SDS-max hammers ■ For drilling and chiselling - with different attachments drill bits from Ø 16-52 mm, pointed and flat chisel up to 25 mm ■ Tool-free installation - drill bit and chisel can be removed without detaching the extraction system ■ Compatible with all new Metabo SDS-max hammers in connection with all Metabo M- and H-vacuum cleaners ■ External dust extraction Drill bit-Ø: 16 - 52 mm	623271000
NEW		
	ESA plus extraction set for all Metabo SDS-plus hammers ■ For drilling Ø 5-32 mm ■ Flexible 360° dust cap, adjustment to 160 mm and 210 mm drill bit ■ Compatible with all new Metabo SDS-plus hammers in connection with all Metabo M- and H-vacuum cleaners ■ External dust extraction Drill-Ø: 5 - 32 mm	623770000*
NEW		
	Vacuum cleaner adapter DDE 14 ■ Vacuum cleaner adapter for extracting drilling dust at the hole entry point ■ Safe and dust-free drilling in walls and ceilings ■ By virtue of the 2-chamber system and the foam rubber gasket it stays attached to almost all (even uneven) surfaces, such as plaster, natural stone and woodchip wallpaper. Minimal drill dust residue at walls and wallpapers. ■ The adapter is put on the existing suction hose. The negative pressure of the vacuum cleaner keeps the adapter to the respective subsurface. Drill Ø: 4 - 14 mm	630829000*
	Vacuum cleaner adapter DDE 72 Features see above Drill Ø: 72 mm	631343000*
	ISA 18 LTX 24 Integrated Dust Extraction ■ Extremely light and compact dust extraction for dust-free drilling in concrete, stone and masonry ■ Simple, tool-free installation to the cordless hammer KHA 18 LTX BL 24 Quick ■ Ideal for working overhead or in areas sensible to dust ■ Health-friendly working with HEPA filter for smallest dust particles ■ Precise setting for different drilling depths and drill bit lengths ■ Tool-free replaceable suction head with low-wear brushes ■ 3 Second delay to extract the remaining dust from the drill hole ■ Transparent collection container can be emptied easily, e.g. for 160 bores Ø 6 / 40 mm ■ 100% Drilling performance with active dust extraction thanks to being driven by own motor Drill bit-Ø: 5 - 16 mm Max. drill bit length: 160 mm Rated input power: 65 W Weight: 1.1 kg Scope of delivery: replacement extraction head, Metaloc II	631341840
	ISA 18 LTX 24 Integrated Dust Extraction Scope of delivery: replacement extraction head	631341890

	Extraction head set, 2 pieces for ISA 18 LTX ■ Original suction head for highest suction performance with the ISA 18 LTX	623767000
	HEPA Filter for ISA 18 LTX ■ HEPA filter for highest health protection ■ Keeps back 99.995% of fine dusts larger than 0.3 µm	623768000
	Special grease ■ For shank ends of hammer drill bits, chisels, adapters etc.; prevents friction and wear coefficient; bio-degradable ■ High durability, high resistance to heat, high anti-corrosion properties	631800000
	Metabo VibraTech (MVT) side handle ■ Suitable for UHE 28 Plus, KHE 28 Plus	631595000

01

02

03

04

05

06

07

08

09

10

11

12

13

14

15

16

*Self-service packaging

Chucks: Precise fit and long service life.

Simple handling, secure fit and long service life are the quality factors of a quality chuck. The Metabo Futuro Top chucks have a spring-loaded bit clamping mechanism for precise fit, and the hardened and ground components (clamping jaws, guide sleeve and the chuck body) of the chuck ensure a long service life and precise working.

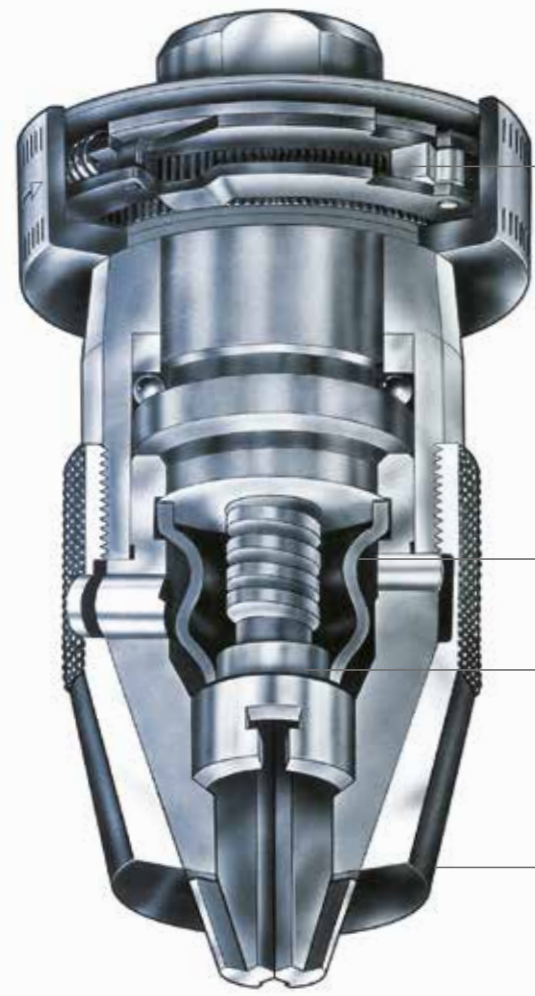

Metabo Futuro Top keyless chuck

Spring-loaded safety feature

To ensure secure grip of the drill bit, even in the most demanding continuous mode of 62,000 strokes/min.

Dual dust protection

Any dust that gets between the jaw guide and the rubber bellow is ejected through the openings in the chuck sleeve.

A hard-wearing, oil-resistant rubber bellows system protects the thread and the precision press fit from contamination.

Precise fitting parts and a long service life

All of the heavily used parts of the chuck are hardened. The clamping jaws, the guide sleeves and the chuck body have a ground finish.



Easy to use

The chuck can be opened easily and conveniently even after it has been used for tough drilling or impact drilling jobs.



Warranty for optimal quality

More than 30 inspection points monitor the manufacture of the individual parts.



After assembly, each chuck is checked thoroughly for concentric operation and functional safety.

Chucks

Keyless chucks, impact-proof

	Clamping width mm	Female thread	Outer Ø mm	Length (closed) mm	Weight kg	Order no.
	Futuro Top keyless chucks, R					
	■ The first impact-proof keyless chuck, with integrated spring-loaded bit clamping mechanism and dual dust protection					
	■ Keyless for quick tool change					
	■ Firm grip of clamped tools even under the toughest loads					
	■ The oil-resistant, hard-wearing rubber bellows system protects the thread and the precision press fit from dust and dirt					
	■ For clockwise rotating drills only					
	1 - 10	3/8"-24 UNF	42,8	77	0,35	636215000
	1 - 10	1/2"-20 UNF	42,8	77	0,35	636216000
	1 - 10	B12	42,8	77	0,35	636217000
	1 - 13	3/8"-24 UNF	42,8	89	0,5	636225000
	1 - 13	1/2"-20 UNF	42,8	89	0,5	636226000
	1 - 13	B16	42,8	103	0,6	636227000
	3 - 16	5/8" - 16 UN	50	113	1	636241000
	3 - 16	B16	50	113	1	636242000
3 - 16	B18	50	113	1	636243000	
1 - 10	1/2"-20 UNF	42,8	77	0,35	636601000*	
1 - 13	1/2"-20 UNF	42,8	89	0,5	636602000*	



Futuro Plus keyless chucks S1 M, R+L

- Special design for impact drills with spindle stop
- Sturdy version with metal sleeve
- Single sleeve (without supporting ring)
- Keyless for quick tool change
- Impact-proof version
- Drills through using locking screw for clockwise and anti-clockwise operating machines
- With spanner flat for assembly and disassembly



1,5 - 13	1/2"-20 UNF	42,9	72,4	0,3	636621000*
Chuck display					
■ Contents: 6 pieces Futuro Plus S1M (636621000) 13 mm, 1/2" in counter display					
636625000*					



Futuro Plus keyless chucks S1, R + L

- Specially developed for lightweight impact drills with spindle stop
- Plastic sleeve
- Single sleeve (without supporting ring)
- Keyless for quick tool change
- Impact-proof version
- Drills through using locking screw for clockwise and anti-clockwise operating machines
- With spanner flat for assembly and disassembly

1 - 10	3/8"-24 UNF	42,7	61	0,2	636615000*
1 - 10	1/2"-20 UNF	42,7	61	0,2	636616000*
1,5 - 13	1/2"-20 UNF	42,7	72,4	0,2	636617000*



Futuro Plus keyless chucks S2 M, R + L

- Specially developed for impact drills
- Sturdy design with metal sleeve. Version 636619000 with hardened carbide jaws
- Double sleeve with radial locking for secure tool clamping
- Keyless for quick tool change
- Impact-proof version
- Drills through using locking screw for clockwise and anti-clockwise operating machines
- With spanner flat for assembly and disassembly





1,5 - 13	1/2"-20 UNF	42,9	72,4	0,3	636620000*
1,5 - 13	1/2"-20 UNF	42,9	72,4	0,3	636619000*
Chuck display					
■ Contents: 6 pieces Futuro Plus S2M (636620000) 13 mm, 1/2" in counter display					
636624000*					

*Self-service packaging

	Clamping width mm	Female thread	Outer Ø mm	Length (closed) mm	Weight kg	Order no.
	Futuro Plus keyless chucks S2, R + L					
	<ul style="list-style-type: none"> ■ Specially developed for lightweight impact drills ■ Plastic sleeve ■ Double sleeve with radial locking for secure tool clamping ■ Keyless for quick tool change ■ Impact-proof version ■ Drills through using locking screw for clockwise and anti-clockwise operating machines ■ With spanner flat for assembly and disassembly 					
	1 - 10	3/8"-24 UNF	42,8	61	0,2	636612000*
	1 - 10	1/2"-20 UNF	42,8	61	0,2	636613000*
	1,5 - 13	1/2"-20 UNF	42,8	72,4	0,2	636614000*

Keyless chucks, not impact-proof

	Clamping width mm	Female thread	Outer Ø mm	Length (closed) mm	Weight kg	Order no.
	Futuro R keyless chucks					
	<ul style="list-style-type: none"> ■ Keyless clamping of insertion tools to hand-held and fixed drills ■ The chuck readjusts its tension to match the increasing cutting pressure on the cutting bit ■ The chuck can be opened easily by hand even after the toughest drilling jobs ■ For maximum load ■ For clockwise rotating drills only ■ Not impact-proof 					
	1 - 10	3/8"-24 UNF	37,5	77	0,35	636321000
	1 - 10	1/2"-20 UNF	37,5	77	0,35	636322000
	1 - 10	B12	37,5	77	0,35	636323000
	1 - 10	B16	40,5	103	0,6	636333000
	1 - 13	3/8"-24 UNF	40,5	89	0,6	636341000
	1 - 13	1/2"-20 UNF	40,5	89	0,6	636342000
	1 - 13	B16	40,5	103	0,6	636343000
	1 - 13	1/2"-20 UNF	47,5	111	0,8	636351000
	1 - 13	B16	47,5	111	0,8	636353000
	1 - 13	J6	47,5	111	0,8	636356000
	3 - 16	5/8"-16 UN	50	113	1	636361000
	3 - 16	B16	50	113	1	636362000
	3 - 16	B18	50	113	1	636363000
	3 - 16	J6	50	113	1	636364000

	Futuro Plus keyless chucks H2, R + L					
	<ul style="list-style-type: none"> ■ Specially developed for cordless and lightweight drills ■ Plastic sleeve ■ Double sleeve with supporting ring for firm grip of tools ■ Keyless for quick tool change ■ Not impact-proof ■ Drills through using locking screw for clockwise and anti-clockwise operating machines ■ With spanner flat for assembly and disassembly 					
	1 - 10	3/8"-24 UNF	42,7	61	0,2	636518000*
	1 - 10	1/2"-20 UNF	42,7	61	0,2	636519000*
	1,5 - 13	1/2"-20 UNF	42,7	72,4	0,2	636520000*

Guide for chuck designations:

- B = conical
- J = Jacobs
- S = impact-proof
- 1 or 2 = number of sleeves
- M = metal version
- R = for clockwise rotation
- R+L = for clockwise and anticlockwise rotation

	Clamping width mm	Female thread	Outer Ø mm	Length (closed) mm	Weight kg	Order no.
	Futuro Plus keyless chucks H1, R + L					
	<ul style="list-style-type: none"> ■ Special design for drills with spindle stop ■ Plastic sleeve ■ Single sleeve without supporting ring ■ Keyless for quick tool change ■ Not impact-proof ■ Drills through using locking screw for clockwise and anti-clockwise operating machines ■ With spanner flat for assembly and disassembly 					
	1 - 10	1/2"-20 UNF	40	49	0,15	636219000*
	1 - 10	3/8"-24 UNF	42,7	61	0,2	636515000*
	1,5 - 13	1/2"-20 UNF	42,7	72,4	0,2	636517000*
	1,5 - 13	1/2"-20 UNF	42,7	61	0,2	636609000*

Geared chucks, impact-proof

	Clamping width mm	Female thread	Outer Ø mm	Length (closed) mm	Weight kg	Key size	Order no.
	Geared chucks with key, clockwise rotation						
	<ul style="list-style-type: none"> ■ Tried and tested 1000 times ■ The chuck for every type of job ■ With female thread or female taper for hand-held or fixed drills as well as for hand-held impact drills ■ The clamping force remains constant during drilling and impact drilling ■ For clockwise rotating drills only 						
	0,5 - 6,5	3/8"-24 UNF	30	53	0,17	1	635008000*
	1 - 10	3/8"-24 UNF	33,3	61	0,21	2	635019000
	1 - 10	1/2"-20 UNF	33,3	61	0,2	2	635072000*
	1,5 - 13	3/8"-24 UNF	42,5	74	0,32	2	635033000
	1,5 - 13	1/2"-20 UNF	42,5	74	0,31	2	635302000*
	1,5 - 13	B16	42,5	78	0,35	2	635036000*
	3 - 16	1/2"-20 UNF	50	87,5	0,6	3	635054000
	3 - 16	5/8"-16 UN	50	87,5	0,59	3	635056000
	3 - 16	B16	50	86	0,64	3	635050000*
	3 - 16	B18	50	94,5	0,63	3	635049000
	5 - 20	B22	65	113	0,75	4	635058000

	Geared chucks with key, R + L						
	<ul style="list-style-type: none"> ■ Tried and tested 1000 times ■ The chuck for every type of job ■ With female thread or female taper for hand-held or fixed drills as well as for hand-held impact drills ■ The clamping force remains constant during drilling and impact drilling ■ Drills through using locking screw for clockwise and anti-clockwise operating machines 						
	1 - 10	3/8"-24 UNF	33,3	61	0,17	2	635254000*
	1 - 10	1/2"-20 UNF	33,3	61	0,17	2	635252000*
	1,5 - 13	3/8"-24 UNF	42,5	74	0,31	2	635255000*
	3 - 16	5/8"-16 UN	50	87,5	0,6	2	635253000*
	1,5 - 13	1/2"-20 UNF	42,5	74	0,32	2	635304000*

*Self-service packaging

Chuck accessories

Spare chuck keys

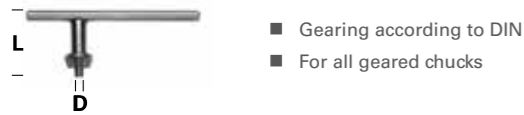

- Gearing according to DIN
- For all geared chucks

Key size	Spigot Ø D mm	Shaft length L mm	Order no.
1	4	30	635165000*
2	6	42	635167000*
3	8	50	635168000*
4	9	55	635169000*

Morse tapers for chucks

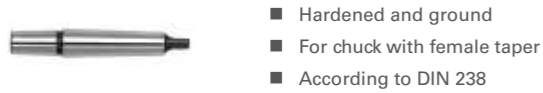

- Hardened and ground
- For chuck with female taper
- According to DIN 238

Outer morse taper Ø	Chuck cone	Overall morse taper length mm	Weight kg	Order no.
MK 1	B 12	89	0,065	635104000
MK 1	B 16	97	0,09	635105000
MK 2	B 12	106,5	0,135	635114000
MK 2	B 16	110,5	0,16	635115000
MK 2	B 18	117,5	0,18	635116000
MK 3	B 16	134	0,31	635125000
MK 3	B 18	141	0,32	635126000
MK 3	B 22	147	0,39	635128000
MK 4	B 16	159	0,625	635132000
MK 4	B 18	168	0,66	635133000

Reducing inserts



- Standard type
- Similar to DIN 2185
- Ground male taper

Outer morse taper Ø	Internal morse taper Ø	Overall length mm	Weight kg	Order no.
MK 3	MK 2	112	0,19	635143000
MK 4	MK 2	124	0,48	635144000
MK 4	MK 3	140	0,36	635146000

Drift Keys

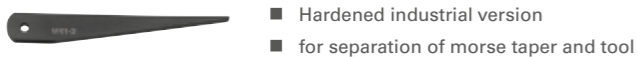

- Hardened industrial version
- for separation of morse taper and tool

Suitable for machine with morse taper	Overall length mm	Weight kg	Order no.
MK 1, MK 2	140	0,07	642395000
MK 3	190	0,15	642396000

*Self-service packaging

The Metabo Quick System: Versatile and comfortable.



Quick and efficient working

Quick change of bit retainer and accessory for flexible working

Increase in efficiency with competence accessories

Thanks to the magnetised female hexagon socket, hex bits or screwdriver bits can be inserted directly into the machine spindle. This assists drilling and screwdriving use in confined spaces and direct torque transmission.

Numerous Metabo cordless drill/screwdriver and impact hammers of the L, LT and LTX class, as well as the cordless tappers and the mains-powered drill BE 75 Quick are equipped with the Quick System. All these types contain the addition »Quick« and the designation of the class (L, LT or LTX).

Which Quick accessories are suited for which machine types, can be found in the following system overview.

L + PowerMaxx



Quick-change chuck Futuro Plus H 1 R+L, »Quick«
Order no. 627259000



Quick-change bit holder »Quick«
Order no. 627241000



Quick-change angle adapter »Quick«
Order no. 627261000



Off-set attachment »Quick«
Order no. 627234000

LT



Quick-change chuck Futuro Plus S 1 M, »Quick«
Order no. 627240000



Quick-change bit holder »Quick«
Order no. 627241000



Quick-change angle adapter »Quick«
Order no. 627077000



Quick-change chuck Futuro Plus S 1 M/HM, »Quick«
Order no. 627203000

LTX

+ BE 75



Quick-change geared chuck »Quick«
Order no. 627238000



Quick-change bit holder »Quick«
Order no. 627241000



Quick-change angle adapter »Quick«
Order no. 627242000



Off-set attachment »Quick«
Order no. 627343000



Quick change tapping chuck M4-M6 627235000*
M8-M12 627237000*









Torque setting adapter PowerX3 DC
Order no. 627232000



Torque setting adapter PowerX3
Order no. 627256000

*only for tappers

Accessories for »Quick« drills and drills/screwdrivers		Order no.
	<p>PowerX3 DC torque setting adapter</p> <ul style="list-style-type: none"> The torque setting adapter enables the power of the tool (torque) to be tripled to handle tough jobs Suitable for all Metabo cordless drills/screwdrivers, cordless hammer drills and drills with Metabo »Quick«- quick change system in combination with 43 mm collet Standard equipment incl. geared chuck 1/2" 3-16 mm and adapter for adjusting the handle length Bit retainer with 1/2" male square and 1/4" (6.35 mm) female hexagon socket <p>Attention: Use the PowerX3 DC in conjunction with the following tools only and using the stipulated length of the handle depending on the torque: all cordless drill/screwdrivers and LTX »Quick« hammer drills as well as BE 75 Quick drill: 640 mm handle length; BE 1300 Quick drill: 380 mm handle length.</p>	627232000
	<p>PowerX3 torque setting adapter</p> <ul style="list-style-type: none"> The torque setting adapter enables the power of the tool (torque) to be tripled to handle tough jobs Suitable for all Metabo cordless drills/screwdrivers, cordless hammer drills and drills with Metabo »Quick«- quick change system in combination with 43 mm collet Standard equipment incl. bit (1 x TX 50) and adapter for adjusting the handle length Bit retainer with 1/2" male square and 1/4" (6.35 mm) female hexagon socket <p>Attention: Use the PowerX3 in conjunction with the following tools only and using the stipulated length of the handle depending on the torque: all cordless drill/screwdrivers and LTX »Quick« hammer drills as well as BE 75 Quick drill: 640 mm handle length; BE 1300 Quick drill: 380 mm handle length.</p>	627256000
	<p>Quick-change chuck Futuro Plus S 1 M/HM, »Quick«</p> <ul style="list-style-type: none"> Simple, fast and convenient chuck change thanks to the Metabo »Quick« change system All-metal chuck with carbide-tipped clamping jaws and high clamping forces Stable version with metal sleeve; 1 sleeve; impact-resistant version; suitable for clockwise and anti-clockwise rotation Clamping width: 1.5 - 13 mm Suitable for all Metabo »Quick« machines 	627203000*
	<p>Quick-change chuck Futuro Plus S 1 M, »Quick«</p> <ul style="list-style-type: none"> Simple, fast and convenient chuck change thanks to the Metabo »Quick« change system Stable version with metal sleeve; 1 sleeve; impact-resistant version; suitable for clockwise and anti-clockwise rotation Clamping width: 1.5 - 13 mm Suitable for all Metabo »Quick« machines 	627240000*
	<p>Quick-change chuck Futuro Plus H 1 R+L, »Quick«</p> <ul style="list-style-type: none"> Simple, fast and convenient chuck change thanks to the Metabo »Quick« change system Version with metal sleeve; 1 sleeve; impact-resistant model; suitable for clockwise and anti-clockwise rotation Clamping width: 1.0 - 10 mm Suitable for all Metabo »Quick« machines 	627259000*
	<p>Quick-change chuck Futuro Plus H 1 R+L, »Quick«</p> <ul style="list-style-type: none"> Simple, fast and convenient chuck change thanks to the Metabo »Quick« change system Compact version with plastic sleeve; 1 sleeve; impact-resistant model; suitable for clockwise and anti-clockwise rotation Clamping width: 1.5 - 13 mm Suitable for all Metabo »Quick« machines 	636608000*
	<p>Quick change threaded chuck M4 - M6</p> <ul style="list-style-type: none"> Keyless chuck for inserting taps with square and cylindrical shanks Simple, fast and convenient chuck change thanks to the Metabo »Quick« change system Version with metal sleeve; 1 sleeve; impact-resistant model; suitable for clockwise and anti-clockwise rotation Clamping width: 1.5-8 mm; drill chuck with square holder 3.5 mm for M4 and 5.0 mm for M6 Suitable for all Metabo »Quick« machines 	627235000*

*Self-service packaging

	<p>Quick change threaded chuck M8 - M12</p> <ul style="list-style-type: none"> Keyless chuck for inserting taps with square and cylindrical shanks Simple, fast and convenient chuck change thanks to the Metabo »Quick« change system Version with metal sleeve; 1 sleeve; impact-resistant model; suitable for clockwise and anti-clockwise rotation Clamping width: 1.5-13 mm; chuck with square holder 6.0 mm for M8 and 8.1 mm for M10 and M12 Suitable for all Metabo »Quick« machines 	627237000*
	<p>Quick-change geared chuck »Quick«</p> <ul style="list-style-type: none"> Simple, fast and convenient chuck change thanks to the Metabo »Quick« change system Impact-proof version; suitable for clockwise and anti-clockwise rotation Clamping width: 1.5 - 13 mm Suitable for all Metabo »Quick« machines 	627238000*
	<p>Quick-change bit holder »Quick«</p> <ul style="list-style-type: none"> Easy, fast and comfortable change of the bit holder thanks to Metabo quick change system »Quick« Bit holder suitable for bits with 1/4" external hexagonal drive according to DIN 3126- C 6.3 and E 6.3 Suitable for all Metabo »Quick« machines 	627241000*
	<p>Quick-change angle adapter »Quick«</p> <ul style="list-style-type: none"> Quick and comfortable fixing of angle adapter without tools Quick spindle for fixing the quick change angle adapter 627240000 and bit holder 627241000 Magnetic bit holder with 1/4" (6.35 mm) hexagonal shank Suitable for forward and reverse rotation Suitable for cordless tools up to a maximum of 110 Nm Suitable for all Metabo »Quick« machines with collet Ø 43 mm 	627242000*
	<p>Quick-change angle adapter »Quick«</p> <ul style="list-style-type: none"> Quick and comfortable fixing of angle adapter without tools Quick spindle for fixing the quick change angle adapter 627240000 and bit holder 627241000 Magnetic bit holder with 1/4" (6.35 mm) hexagonal shank Suitable for forward and reverse rotation Suitable for cordless tools up to a maximum of 100 Nm Suitable for all Metabo LT »Quick« models (from year of construction 02/2013) 	627077000*
	<p>Quick-change angle adapter »Quick«</p> <ul style="list-style-type: none"> For drilling and fixing screws in hard to reach places Magnetic bit holder with 1/4" (6.35 mm) hexagonal shank Gears made of special steel Suitable for forward and reverse rotation; up to max. 28 Nm Especially for PowerMaxx BS Quick and BS 18 Quick 	627261000*
	<p>Off-set attachment</p> <ul style="list-style-type: none"> The off-set attachment permits working near edges and walls. The dimension across corners is 11 mm The attachment can be adjusted in 12 different positions Lockable 1/4" universal bit holder for all standard screwdriver bits 3-piece set: »Quick« off-set attachment, anti-vibration handle, spacer bolt <p>Suitable for Metabo BS 18 LTX BL Q I; SB 18 LTX BL Q I; BS 18 LTX-3 BL Q I; SB 18 LTX-3 BL Q I, GB 18 LTX BL Q I; BS 18 LTX Quick</p>	627343000*
	<p>Off-set attachment »Quick«</p> <ul style="list-style-type: none"> The off-set attachment permits working near edges and walls. The dimension across corners is 11.2 mm The attachment can be adjusted in 12 different positions Lockable 1/4" universal bit holder for all standard screwdriver bits <p>Suitable for Metabo PowerMaxx BS Quick, PowerMaxx BS 12 Q, PowerMaxx BS 12 BL Q, BS 18 Quick, BS 18 L BL Q</p>	627234000*

*Self-service packaging

Metal drill bit



HSS-R Metal drill bits, DIN 338, roll-milled

Spiral drill bit made of high-grade high-speed steel according to DIN 338, roll-milled, cylindrical, right-hand cutting, type N, black surface

Application:
Suitable for drilling in the common metals such as steel, non-ferrous metals, alloyed and non-alloyed cast steel. Up to 900 N/mm² tensile strength.

HSS-G metal drill bits, DIN 338, ground

Precision spiral drill bit made of high-grade high-speed steel according to DIN 338, precision ground, cylindrical, right-hand cutting, type N, crosswise grinding 135° according to DIN 1412 C (from 3 mm), polished surface

Application:
For maximum load and precision in crafts and industry. For drilling in steel and cast steel, alloyed and unalloyed, grey cast iron, sintered iron, nickel silver, graphite etc. Up to 900 N/mm² tensile strength.

HSS-Co metal drill bits, DIN 338, ground

Precision spiral drill bit made of cobalt-alloyed high-grade high-speed steel according to DIN 338, precision-ground, cylindrical, type N, reinforced core thickness, with crosswise grinding 135° (from 2 mm) according to DIN 1412 C, bronze surface

Application:
For maximum load and precision in crafts and industry. For drilling hard-to-machine materials such as heat, corrosion and acid resistant steels, VA steel, special alloys, welded seams, CrNi-steels. Up to 1100 N/mm² tensile strength.

HSS-TiN metal drill bits, DIN 338, ground

Precision spiral drill made of titanium coated high-grade high-speed steel according to DIN 338, precision ground, cylindrical, right-hand cutting, type N, crosswise ground 135° (from 3 mm upwards) to DIN 1412 C, gold colour surface finish.

Application:
For maximum load and precision in crafts and industry. For drilling steel and cast-steel, alloyed and non-alloyed, grey cast iron, annealed cast-iron, nickel silver, graphite, bronze and brass. Up to 900 N/mm² tensile strength. HSS-TiN drill bits are not suited for processing aluminium.

Metal drill bit

HSS-R metal drill bits, DIN 338, roll-milled



- Spiral drill bit made of high-grade high-speed steel according to DIN 338, roll-milled, cylindrical, right-hand cutting, type N
- Cone-shaped shell polished surface 118°, diameter tolerance h8
- Black surface
- Suitable for drilling in steel, non-ferrous metals, alloyed and non-alloyed cast steel. Up to 900 N/mm² tensile strength.

Diameter mm	Overall length mm	Working length mm	Sales unit	Order no.
1	34	12	10	627700000*
1,1	36	14	10	627701000*
1,2	38	16	10	627702000*
1,3	38	16	10	627703000*
1,4	40	18	10	627704000*
1,5	40	18	10	627705000*
1,6	43	20	10	627706000*
1,7	43	20	10	627707000*
1,8	46	22	10	627708000*
1,9	46	22	10	627709000*
2	49	24	10	627710000*
2,1	49	24	10	627711000*
2,2	53	27	10	627712000*
2,3	53	27	10	627713000*
2,4	57	30	10	627714000*
2,5	57	30	10	627715000*
2,6	57	30	10	627716000*
2,7	61	33	10	627717000*
2,8	61	33	10	627718000*
2,9	61	33	10	627719000*
3	61	33	10	627720000*
3,1	65	36	10	627721000*
3,2	65	36	10	627722000*
3,3	65	36	10	627723000*
3,4	70	39	10	627724000*
3,5	70	39	10	627725000*
3,6	70	39	10	627726000*
3,7	70	39	10	627727000*
3,8	75	43	10	627728000*
3,9	75	43	10	627729000*
4	75	43	10	627730000*
4,1	75	43	10	627731000*
4,2	75	43	10	627732000*
4,3	80	47	10	627733000*
4,4	80	47	10	627734000*
4,5	80	47	10	627735000*
4,6	80	47	10	627736000*
4,7	80	47	10	627737000*
4,8	86	52	10	627738000*
4,9	86	52	10	627739000*
5	86	52	10	627740000*
5,1	86	52	10	627741000*
5,2	86	52	10	627742000*
5,3	93	57	10	627743000*
5,4	93	57	10	627744000*
5,5	93	57	10	627745000*
5,6	93	57	10	627746000*
5,7	93	57	10	627747000*
5,8	93	57	10	627748000*
5,9	93	57	10	627749000*
6	93	57	10	627750000*
6,1	101	63	10	627751000*
6,2	101	63	10	627752000*
6,3	101	63	10	627753000*

*Self-service packaging

Diameter mm	Overall length mm	Working length mm	Sales unit	Order no.
6,4	101	63	10	627754000*
6,5	101	63	10	627755000*
6,6	101	63	10	627756000*
6,7	101	63	10	627757000*
6,8	109	69	10	627758000*
6,9	109	69	10	627759000*
7	109	69	10	627760000*
7,1	109	69	10	627761000*
7,2	109	69	10	627762000*
7,3	109	69	10	627763000*
7,4	109	69	10	627764000*
7,5	109	69	10	627765000*
7,6	117	75	10	627766000*
7,7	117	75	10	627767000*
7,8	117	75	10	627768000*
7,9	117	75	10	627769000*
8	117	75	10	627770000*
8,1	117	75	10	627771000*
8,2	117	75	10	627772000*
8,3	117	75	10	627773000*
8,4	117	75	10	627774000*
8,5	117	75	10	627775000*
8,6	125	81	10	627776000*
8,7	125	81	10	627777000*
8,8	125	81	10	627778000*
8,9	125	81	10	627779000*
9	125	81	10	627780000*
9,5	125	81	10	627785000*
10	133	87	10	627790000*
10,2	133	87	5	627792000*
10,5	133	87	5	627795000*
11	142	94	5	627800000*
11,5	142	94	5	627805000*
12	151	101	5	627810000*
12,5	151	101	5	627815000*
13	151	101	5	627820000*
	HSS-R drill bit storage case 6 pieces, in plastic storage case Ø 2 / 3 / 4 / 5 / 6 / 8 mm			627160000*
	HSS-R drill bit storage case 10 pieces, in plastic carry case Ø 1 / 2 / 3 / 4 / 5 / 6 / 7 / 8 / 9 / 10 mm			627158000*
	HSS-R drill bit storage case 13 pieces, in plastic storage case Ø 1,5 / 2 / 2,5 / 3 / 3,2 / 3,5 / 4 / 4,5 / 4,8 / 5 / 5,5 / 6 / 6,5 mm			627161000*
	HSS-R drill bit storage case 13 pieces, in plastic storage case Ø 2 / 2,5 / 3 / 3,5 / 4 / 4,5 / 5 / 5,5 / 6 / 6,5 / 7 / 7,5 / 8 mm			627162000*
	HSS-R drill bit storage case 19 pieces, in robust plastic storage case Ø 1 / 1,5 / 2 / 2,5 / 3 / 3,5 / 4 / 4,5 / 5 / 5,5 / 6 / 6,5 / 7 / 7,5 / 8 / 8,5 / 9 / 9,5 / 10 mm			627164000*

Diameter mm	Overall length mm	Working length mm	Sales unit	Order no.
	HSS-R drill bit storage case 25 pieces, in robust plastic storage case Ø 1 / 1,5 / 2 / 2,5 / 3 / 3,5 / 4 / 4,5 / 5 / 5,5 / 6 / 6,5 / 7 / 7,5 / 8 / 8,5 / 9 / 9,5 / 10 / 10,5 / 11 / 11,5 / 12 / 12,5 / 13 mm			627159000*

HSS-R Metal drill bits, DIN 338, with offset shank



- Spiral drill bit made of high-grade high-speed steel according to DIN 338, roll-milled, cylindrical, right-hand cutting, type N
- Cone-shaped shell polished surface 118°, diameter tolerance h8
- Black surface
- Suitable for drilling in steel, non-ferrous metals, alloyed and non-alloyed cast steel. Up to 900 N/mm² tensile strength.

Diameter mm	Overall length mm	Working length mm	Shaft Ø mm	Sales unit	Order no.
13,5	160	108	10	1	625006000*
14	160	108	10	1	625007000*
15	169	114	10	1	625009000*
16	178	120	10	1	625011000*
17	184	125	13	1	625013000*
18	191	130	13	1	625015000*
19	198	135	13	1	625017000*
20	205	140	13	1	625019000*



HSS-G metal drill bits, DIN 338, ground





- Precision spiral drill bit made of high-grade high-speed steel according to DIN 338, precision ground, cylindrical, right-hand cutting, type N, crosswise grinding 135° according to DIN 1412 C (from 3 mm), diameter tolerance h8
- Bare surface
- For highest demands and precision in industry and crafts.
- For drilling steels, cast steel, alloyed and unalloyed, grey cast iron, tempered cast iron, ductile cast iron, sintered iron, nickel silver, graphite, NF metals, plastic. Up to 900 N/mm² tensile strength.

Diameter mm	Overall length mm	Working length mm	Sales unit	Order no.
1	34	12	10	627852000*
1,5	40	18	10	627857000*
2	49	24	10	627862000*
2,5	57	30	10	627867000*
3	61	33	10	627872000*
3,1	65	36	10	NEW 627972000*
3,2	65	36	10	627874000*
3,3	65	36	10	627875000*
3,5	70	39	10	627877000*
4	75	43	10	627882000*
4,1	75	43	10	627883000*
4,2	75	43	10	627884000*
4,5	80	47	10	627887000*
4,8	86	52	10	627890000*
4,9	86	52	10	NEW 627974000*
5	86	52	10	627892000*
5,1	86	52	10	627893000*
5,2	86	52	10	627894000*

*Self-service packaging

Diameter mm	Overall length mm	Working length mm	Sales unit	Order no.
5,5	93	57	10	627897000*
6	93	57	10	627902000
6,5	101	63	10	627907000
6,8	109	69	5	627910000
7	109	69	5	627912000
7,5	109	69	5	627917000
8	117	75	5	627922000
8,2	117	75	5	627924000
8,5	117	75	5	627927000
9	125	81	5	627932000
9,5	125	81	5	627937000
10	133	87	5	627942000
10,2	133	87	5	627943000
10,5	133	87	5	627944000
11	142	94	5	627945000
11,5	142	94	5	627946000
12	151	101	5	627947000
12,5	151	101	5	627948000
13	151	101	5	627949000
1	34	12	2	627950000*
1,5	40	18	2	627951000*
2	49	24	2	627952000*
2,5	57	30	2	627953000*
3	61	33	2	627954000*
3,2	65	36	2	627955000*
3,5	70	39	2	627957000*
4	75	43	2	627958000*
4,2	80	47	1	627960000*
4,5	80	47	1	627961000*
4,8	86	52	1	627962000*
5	86	52	1	627963000*
5,5	93	57	1	627966000*
6	93	57	1	627967000*
6,5	101	63	1	627968000*
6,8	109	69	1	627969000*
7	109	69	1	627970000*
7,5	109	69	1	627971000*
8	117	75	1	627973000*
8,5	117	75	1	627975000*
9	125	81	1	627976000*
9,5	125	81	1	627977000*
10	133	87	1	627978000*
10,5	133	87	1	627980000*
11	142	94	1	627981000*
11,5	142	94	1	627982000*
12	151	101	1	627983000*
12,5	151	101	1	627984000*
13	151	101	1	627985000*
	HSS-G drill bit storage case 13 pieces, in plastic storage case Ø 1,5 / 2 / 2,5 / 3 / 3,2 / 3,5 / 4 / 4,5 / 4,8 / 5 / 5,5 / 6 / 6,5 mm			627096000*
	HSS-G drill bit storage case 19 pieces, in robust plastic carry case Ø 1 / 1,5 / 2 / 2,5 / 3 / 3,5 / 4 / 4,5 / 5 / 5,5 / 6 / 6,5 / 7 / 7,5 / 8 / 8,5 / 9 / 9,5 / 10 mm			627097000*

Accessory sets can be found in chapter 31, from page 288

Diameter mm	Overall length mm	Working length mm	Sales unit	Order no.
	HSS-G drill bit storage case 25 pieces, in robust plastic storage case Ø 1 / 1,5 / 2 / 2,5 / 3 / 3,5 / 4 / 4,5 / 5 / 5,5 / 6 / 6,5 / 7 / 7,5 / 8 / 8,5 / 9 / 9,5 / 10 / 10,5 / 11 / 11,5 / 12 / 12,5 / 13 mm			627098000*
	HSS-G drill bit storage case 7-piece, in plastic carry case. Especially tailored drill bit set for rivet sizes of cordless blind rivet gun NP18 LTX BL 5.0 Ø 2.5 / 3.1 / 2x 3.3 / 4.1 / 4.9 / 5.1 mm			627979000*

NEW

HSS-G Metal drill bits long, DIN 340



- Precision spiral drill bit made of high-grade high-speed steel according to DIN 340, ground from the solid, long, cylindrical, right-hand cutting, type N, crosswise grinding 135° according to DIN 1412 C (from 3 mm), diameter tolerance h8
- Bare surface
- For highest demands and precision in industry and handcraft
- For drilling steels, cast steel, alloyed and unalloyed, grey cast iron, ductile cast iron, sintered iron, nickel silver, graphite. Up to 900 N/mm² tensile strength.

Diameter mm	Overall length mm	Working length mm	Sales unit	Order no.
2	85	56	1	625031000*
3	100	66	1	625033000*
4	119	78	1	625038000*
5	132	87	1	625043000*
6	139	91	1	625050000*
7	156	102	1	625053000*
8	165	109	1	625055000*
9	175	115	1	625057000*
10	184	121	1	625059000*
11	195	128	1	625062000*
12	205	134	1	625064000*
13	205	134	1	625066000*

HSS-G Metal drill bits , DIN 3126, with hexagonal shank



- High-quality precision tool made of the finest hardened steel
- Precision ground from one piece
- Ideal for the new generation of drills equipped with quick-change keyless chuck according to DIN 3126.
- Strict compliance with DIN 3126 E6.3 ensures that the chuck is not damaged.

Diameter mm	Overall length mm	Working length mm	Sales unit	Order no.
2	47	16	1	627514000*
3	47	16	1	627515000*
4	53	20	1	627516000*
5	59	26	1	627517000*
6	59	26	1	627518000*
8	60	32	1	627519000*
	HSS-G drill bit storage case 5 pieces, with hexagonal shank (E 6.3), in plastic storage case Ø 3 / 4 / 5 / 6 / 8 mm			627112000*

*Self-service packaging

HSS-Co. metal drill bits DIN 338



- Precision spiral drill bit made of cobalt-alloyed high-grade high-speed steel according to DIN 338, precision-ground, cylindrical, type N, reinforced core thickness, with crosswise grinding 135° according to DIN 1412 C (from 2 mm), diameter tolerance h8
- Bronze surface
- For exceptional demands and precision work in handcraft and industry
- For drilling in steel, VA-steel, cast steel, non-ferrous metals, plastics, special alloys, chrome vanadium steel up to 1100 N/mm² tensile strength

Diameter mm	Overall length mm	Working length mm	Sales unit	Order no.
1	34	12	2	627430000*
1,5	40	18	2	627431000*
2	49	24	2	627432000*
2,5	57	30	2	627433000*
3	61	33	2	627435000*
3,2	65	36	2	627436000*
3,3	65	36	2	627437000*
3,5	70	39	2	627438000*
4	75	43	2	627439000*
4,1	75	43	1	627440000*
4,2	75	43	1	627441000*
4,5	80	47	1	627442000*
4,8	86	52	1	627443000*
5	86	52	1	627444000*
5,1	86	52	1	627445000*
5,2	86	52	1	627446000*
5,5	93	57	1	627447000*
6	93	57	1	627448000*
6,5	101	63	1	627449000*
6,8	109	69	1	627450000*
7	109	69	1	627451000*
7,5	109	69	1	627452000*
8	117	75	1	627454000*
8,5	117	75	1	627456000*
9	125	81	1	627457000*
9,5	125	81	1	627458000*
10	133	87	1	627459000*
10,2	133	87	1	627460000*
10,5	133	87	1	627461000*
11	142	94	1	627462000*
11,5	142	94	1	627463000*
12	151	101	1	627464000*
12,5	151	101	1	627465000*
13	151	101	1	627466000*



HSS-Co drill bit storage case
6 pieces, in plastic storage case
Ø 2 / 3 / 4 / 5 / 6 / 8 mm

627119000*



HSS-Co drill bit storage case
13 pieces, in plastic storage case
Ø 1,5 / 2 / 2,5 / 3 / 3,2 / 3,5 / 4 / 4,5 / 4,8 / 5 / 5,5 / 6 / 6,5 mm

627120000*



HSS-Co drill bit storage case
19 pieces, in robust plastic storage case
Ø 1 / 1,5 / 2 / 2,5 / 3 / 3,5 / 4 / 4,5 / 5 / 5,5 / 6 / 6,5 / 7 / 7,5 / 8 / 8,5 / 9 / 9,5 / 10 mm

627121000*





HSS-Co drill bit storage case
25 pieces, in robust plastic storage case
Ø 1 / 1,5 / 2 / 2,5 / 3 / 3,5 / 4 / 4,5 / 5 / 5,5 / 6 / 6,5 / 7 / 7,5 / 8 / 8,5 / 9 / 9,5 / 10 / 10,5 / 11 / 11,5 / 12 / 12,5 / 13 mm

627122000*

*Self-service packaging

HSS-TiN metal drill bits, DIN 338

- Precision spiral drill bit made from TiN-coated high-speed steel, precision-ground, cylindrical, type N
- Not suitable for processing aluminium

	Order no.
 <p>HSS-TiN drill bit storage case 6 pieces, in plastic storage case Ø 2 / 3 / 4 / 5 / 6 / 8 mm</p>	627171000*
 <p>HSS-TiN drill bit storage case 19 pieces, in robust plastic storage case Ø 1 / 1,5 / 2 / 2,5 / 3 / 3,5 / 4 / 4,5 / 5 / 5,5 / 6 / 6,5 / 7 / 7,5 / 8 / 8,5 / 9 / 9,5 / 10 mm</p>	627173000*
 <p>HSS-TiN drill bit storage case 25 pieces, in robust plastic storage case Ø 1 / 1,5 / 2 / 2,5 / 3 / 3,5 / 4 / 4,5 / 5 / 5,5 / 6 / 6,5 / 7 / 7,5 / 8 / 8,5 / 9 / 9,5 / 10 / 10,5 / 11 / 11,5 / 12 / 12,5 / 13 mm</p>	627191000*

HSS Form work drill bits, DIN 7490



- Spiral drill bit made of HSS steel for extra long tool life
- Corresponds to the safety requirements of the Wood Professional Association according to DIN 7490
- No clamping in drill hole, good chip removal
- For drilling through formwork in the construction industry as well as boards, beams, planks and floor boards made of soft and hard wood. Also suitable as a facade and roofer's drill bit for metal, profile sheets etc.

Diameter mm	Overall length mm	Sales unit	Order no.
6	400	1	627330000*
8	400	1	627331000*
10	400	1	627332000*
12	400	1	627333000*
14	400	1	627334000*
16	400	1	627335000*
18	400	1	627336000*
20	400	1	627337000*
22	400	1	627338000*
8	600	1	627401000*
10	600	1	627402000*
12	600	1	627403000*
14	600	1	627404000*
16	600	1	627405000*

Router bit



- Router bit made of HSS steel with very efficient routing spirals, crosswise grinding 135° according to DIN 1412 C, titanium nitride coating
- Extremely suitable for drilling and moulding/routing any contours in sheet metal and other thin-walled materials

Diameter mm	Overall length mm	Sales unit	Order no.
6	90	1	625150000*

Masonry drill bits, universal drill bits



Masonry drill bit, carbide-tipped

Very robust, high-grade masonry drill bits for rotary and impact drills, carbide insert 130°, milled angle groove, straight spiral intake, heat resistant, good durability and long service life.

Application:
For drilling in masonry, natural stone

Concrete drill bits, carbide-tipped, »classic« series

Concrete drill bit for rotary and impact drills, milled angle groove, straight spiral intake, long tool life, heat-resistant, carbide insert 130°, negative chamfer, robust version, surface shot peened

Application:
For drilling in concrete, masonry, natural stone

Concrete drill bits, carbide-tipped, »pro«

High-grade, robust concrete drill bit, carbide plate 130°, especially heat-resistant, very long tool life, with special groove for quick discharge of borehole cuttings, surface blank

Application:
For drilling in granite, concrete, masonry, natural and artificial stone. Suitable for light rotary hammers with a three-jaw chuck

Universal drill bits, carbide-tipped

Multi-purpose drill bit with cylindrical shaft for rotary, non-impact use, diamond ground carbide inserts and a positive aggressive cutting angle, ideally suited for use with cordless tools.



Application:
For drilling in wood, metal, plastic, brick, gypsum boards, aerated concrete, tiles, ceramic, etc.

Masonry drill bits, concrete drill bits

Masonry drill bits, carbide-tipped



- Masonry drill bit for rotary and impact drills, milled version, carbide insert 130°, robust version
- Suitable for drilling in bricks, masonry, natural stone etc.

Diameter mm	Overall length mm	Working length mm	Sales unit	Order no.
3	60	30	1	627467000*
4	75	40	1	627468000*
5	85	50	1	627469000*
5,5	85	50	1	627470000*
6	100	60	1	627471000*
6	150	85	1	627487000*
6	200	135	1	627490000*
7	100	60	1	627473000*
8	120	80	1	627474000*
8	200	135	1	627491000*
10	120	80	1	627476000*
10	200	135	1	627492000*
12	150	85	1	627478000*
12	200	135	1	627493000*
14	150	85	1	627480000*
	Masonry drill bit storage case 5 pieces, in plastic storage case Ø 4 / 5 / 6 / 8 / 10 mm			627192000*
	Masonry drill bit storage case 8 pieces, in plastic storage case Ø 3 / 4 / 5 / 6 / 7 / 8 / 9 / 10 mm			627193000*



Concrete drill bits, carbide-tipped, »classic« series



- Concrete drill bit for rotary and impact drills according to DIN 8039, milled angle groove, straight spiral intake, long tool life, heat-resistant, carbide insert 130°, negative chamfer, robust version
- Surface: shot blasted
- Suitable for drilling in concrete, masonry, natural stone

Diameter mm	Overall length mm	Working length mm	Sales unit	Order no.
3	75	40	1	627623000*
4	85	50	1	627625000*
5	85	50	1	627626000*
5	150	90	1	627665000*
5,5	85	50	1	627627000*
6	100	55	1	627646000*
6	150	90	1	627675000*
6,5	100	55	1	627650000*
7	100	55	1	627651000*
8	120	70	1	627652000*
8	200	150	1	627679000*
9	120	70	1	627653000*
10	120	70	1	627654000*
10	200	150	1	627697000*
11	150	90	1	627655000*
12	150	90	1	627656000*
12	200	150	1	627698000*
13	150	90	1	627657000*
14	150	90	1	627658000*
14	200	150	1	627699000*
15	160	100	1	627659000*

*Self-service packaging

Diameter mm	Overall length mm	Working length mm	Sales unit	Order no.
16	160	100	1	627661000*
18	160	100	1	627662000*
20	160	100	1	627664000*
	Concrete drill bit storage case 5 pieces, in plastic carry case Ø 4 / 5 / 6 / 8 / 10 mm			627180000*
	Concrete drill bit storage case 8 pieces, in plastic carry case Ø 3 / 4 / 5 / 6 / 7 / 8 / 9 / 10 mm			627182000*

Drill bits for concrete, carbide-tipped, »pro« series



- High-grade, robust concrete drill bit according to DIN 8039 with carbide insert 130°, especially heat-resistant, very long tool life, with special groove for quick discharge of drilling debris
- Also suitable for light rotary hammers with a three-jaw chuck
- Suitable for drilling in granite, concrete, masonry, natural and artificial stone

Diameter mm	Overall length mm	Working length mm	Sales unit	Order no.
4	85	50	1	627224000*
5	85	50	1	627225000*
5	150	105	1	627421000*
5,5	85	50	1	627226000*
6	100	55	1	627227000*
6	150	105	1	627423000*
6,5	100	55	1	627228000*
7	100	55	1	627229000*
8	120	70	1	627230000*
8	200	135	1	627426000*
9	120	70	1	627389000*
10	120	70	1	627391000*
10	200	135	1	627427000*
11	150	90	1	627392000*
12	150	90	1	627393000*
12	200	135	1	627428000*
13	150	90	1	627394000*
14	150	90	1	627395000*
14	200	135	1	627429000*
15	150	90	1	627396000*
16	150	90	1	627399000*
18	160	95	1	627409000*
20	160	95	1	627410000*
	Concrete drill bit storage case 5 pieces, in plastic storage case Ø 4 / 5 / 6 / 8 / 10 mm			627181000*

Universal drill bits, glass drill bits

Universal drill bits, carbide-tipped



- Multi-purpose drill bit with straight shank, for rotary use
- With diamond-ground carbide insert and positive, aggressive cutting angle. Ideal also for use in cordless drills
- Suitable for drilling in wood, metal, plastic, brick, gypsum boards, aerated concrete, tiles, ceramic, etc.

Diameter mm	Overall length mm	Working length mm	Sales unit	Order no.
3	70	40	1	627696000*
4	85	50	1	627680000*
5	85	50	1	627681000*
5,5	85	50	1	627682000*
6	100	60	1	627683000*
6	150	90	1	627684000*
7	100	60	1	627687000*
8	120	80	1	627688000*
8	250	200	1	627689000*
10	120	80	1	627691000*
10	250	200	1	627692000*
12	150	90	1	627693000*
12	250	200	1	627694000*
14	250	200	1	627695000*
	Universal drill bit storage case 4 pieces in plastic storage case Ø 5 / 6 / 8 / 10 mm			627185000*

Glass drill bit, carbide tipped



- Glass drill bit with special carbide insert
- For drilling in glass, mirror glass, bottles, tiles, etc.
- Attention: set low speeds and cool sufficiently!

Diameter mm	Overall length mm	Sales unit	Order no.
4	60	1	627243000*
5	70	1	627244000*
6	75	1	627245000*
8	80	1	627246000*
10	100	1	627247000*

Diamond drill bit



- High-performance diamond drill bit for all types of tiles up to a scratch hardness of class 8. Also suitable for glass, porcelain, marble, etc.
- The drill must be cooled continuously with water.

Diameter mm	Overall length mm	Working length mm	Sales unit	Order no.
5	60	35	1	627534000*
6	60	35	1	627535000*
7	60	35	1	627536000*
8	60	35	1	627537000*
10	60	35	1	627538000*
12	60	35	1	627539000*
14	60	35	1	627544000*

*Self-service packaging

01
02
03
04
05
06
07
08
09
10
11
12
13
14
15
16

Diamond tools »Dry«

Diamond drill bits for tiles »Dry«, M14



- M14 Thread for use on angle grinders
- Long service life and fast drilling progress thanks to vacuum hard soldered diamonds
- Easy removal of the drill core thanks to lateral recesses
- No extra cooling required. . For Ø 6-14 mm an additional paraffin emulsion is integrated for improved cooling. We commend to briefly cool the tip with water in case of drilling in quick succession!
- We recommend using the thickness of the tile / fine earthenware / granite board as useful length. As a rule, max. 2 cm granite boards / work boards up to 5 cm can be drilled. Retract the drill bit often from the drilled hole so that it can cool down!
- Important: Do not drill into the subsurface in case of laid material!
- Maximum working speed: 80 m/s

Diameter mm	Overall length mm	Sales unit	Order no.
6	64	1	628300000*
8	64	1	628301000*
10	64	1	628302000*
12	64	1	628303000*
14	64	1	628304000*
18	91	1	628305000*
20	91	1	628306000*
25	91	1	628307000*
32	91	1	628308000*
35	91	1	628309000*
40	91	1	628310000*
45	91	1	628318000*
50	91	1	628311000*
55	91	1	628312000*
60	91	1	628313000*
68	91	1	628314000*
75	91	1	628315000*
82	91	1	628316000*



Diamond drill bit set for tiles »Dry« 7 pieces
Set consisting of: 2 each Ø 6 mm, 2 x 8 mm, 1 each 10 mm, 12 mm, 14 mm

NEW

628321000



Diamond drill bit set for tiles »Dry« , 3 pieces
Set consisting of: 1 each Ø 35 mm, 50 mm, 68 mm;

628322000



Diamond drill bit set for tiles »Dry« 4 pieces
Set consisting of: 1 each Ø 35 mm, 40 mm, 50 mm, 68 mm

NEW

628319000



Diamond drill bit set for tiles »Dry« 7 pieces
Set consisting of: each 1 x Ø 6 mm, 8 mm, 14 mm, 35 mm, 40 mm, 50 mm, 68 mm;

628317000



Diamond drill bit set for tiles »Dry« 6 pieces
Set consists of: 1 each Ø 35 mm, 40 mm, 50 mm, 68 mm + diamond drill bit 20 mm
Diamond cup wheel 50 mm

NEW

628320000

Adapter for diamond drill bits »Dry«



Adapter hexagon 10 mm / M 14
■ For the use of diamond drill bits »Dry« for drills and impact drills
Receptacle: hexagonal 10mm, M 14 male thread

Order no.

630859000*

Diamond drill bit »Dry«, M14



Diamond drill bit »Dry«
■ Diamond drill bit Ø 20 mm for routing, chamfering, drilling and widening
■ Useable length: 40 mm; overall length: 75 mm
■ Connection M14 for use with angle grinder Ø 115 + 125 mm
■ Maximum working speed: 80 m/s

NEW

Order no.

628327000*

Wood drill bit



Wood drill bits CV

Wood spiral drill bit made of high-grade steel, similar to DIN 7487 hardened, with centering point

Application:
For drilling in hard and soft wood, plywood, chipboards, etc.

Auger bits

Auger bit for timber with self centering thread point and pre-cutting action, with hexagonal shaft, especially fast drilling cycle, very good material removal.

Application:
Ideal for drilling deep holes in thick hard and soft wood, especially timber beams.

Forstner drill bit

Similar to DIN 7483, with centering point, 2 main cutters and 2 ring cutters

Application:
For use in hard and soft wood, veneered wooden boards. Suitable for drilling blind holes.

Flat wood drill bit

Wood drill bit made of high-quality steel with centering point for precise drilling and 2-sided cutting for splinter-free drilling. The 1/4" (6.35 mm) hexagonal shaft fits into traditional chucks and E 6.3 holders.

Application:
For fast drilling soft wood, boards, chipboards, plywood, etc.

*Self-service packaging

Wood drill bit

Wood drill bits CV, with centring point



- For use in hard and soft wood, plywood, chipboards, etc.
- Wood spiral drill bit made of high-grade steel, hardened, with centering point
- Similar to DIN 7487

Diameter mm	Overall length mm	Working length mm	Sales unit	Order no.
3	61	33	1	627986000*
4	75	43	1	627987000*
5	86	52	1	627988000*
6	97	60	1	627989000*
7	109	69	1	627990000*
8	117	75	1	627991000*
9	125	80	1	627992000*
10	133	87	1	627993000*
11	142	89	1	627994000*
12	151	96	1	627995000*
13	151	96	1	627996000*
14	151	97	1	627997000*
15	151	97	1	627998000*
16	151	97	1	627999000*
18	180	120	1	627339000*
20	200	130	1	627340000*
	Wood drill bit storage case 5 pieces, in plastic storage case Ø 4 / 5 / 6 / 8 / 10 mm			627200000*
	Wood drill bit storage case 8 pieces, in plastic carry case Ø 3 / 4 / 5 / 6 / 7 / 8 / 9 / 10 mm			627202000*

Rose bit 90°



- 5-cut rose bit made of HSS steel for acute-angled countersinks, with Allen screw, for fitting on wood spiral bits
- Can also be used as depth guide, simply invert the countersink

Diameter mm	Overall length mm	Sales unit	Order no.
3	26	1	625020000*
4	26	1	625021000*
5	26	1	625022000*
6	26	1	625023000*
8	26	1	625024000*
10	26	1	625025000*

Countersinks



- 5-cut countersink made of HSS steel for acute-angled countersinks

Diameter mm	Overall length mm	Sales unit	Order no.
16	43	1	623521000*

Wood drill bit with hexagonal shank, DIN 3126



- High-quality precision tool made of the finest hardened steel
- Precision ground from one piece (not a bolted or welded 2-piece product).
- Ideal for drills equipped with quick change keyless chuck according to DIN 3126.
- Our drill's strict compliance to DIN 3126 E6.3 ensures that the chuck is not damaged.
- With centering point for precise spot-drilling.

Diameter mm	Overall length mm	Working length mm	Sales unit	Order no.
2	55	20	1	627522000*
3	65	35	1	627523000*
4	75	40	1	627524000*
5	85	50	1	627525000*
6	90	55	1	627526000*
8	90	55	1	627527000*
10	100	60	1	627528000*
	Wood drill bit storage case 5 pieces, with hexagonal shank (E 6.3), in plastic storage case Ø 3 / 4 / 5 / 6 / 8 mm			627111000*

Timber auger bits for wood with hexagonal shank



- Timber auger bit with self-centring thread tip and rough cutter
- Ideal for drilling deep holes in hard and soft wood, especially beams
- Auger bit Ø 6-12 mm: hexagonal shank SW 10; auger bit Ø 14-32 mm: hexagonal shank SW 11

Diameter mm	Overall length mm	Working length mm	Sales unit	Order no.
6	230	155	1	627115000*
7	230	155	1	627116000*
8	230	155	1	627124000*
10	230	155	1	627125000*
12	230	155	1	627126000*
14	230	155	1	627127000*
16	230	155	1	627128000*
18	230	155	1	627129000*
20	230	155	1	627130000*
22	230	155	1	627131000*
24	230	155	1	627132000*
26	230	155	1	627133000*
28	230	155	1	627134000*
30	230	155	1	627135000*
32	230	155	1	627136000*
8	460	385	1	627137000*
10	460	385	1	627138000*
12	460	385	1	627139000*
14	460	385	1	627140000*
16	460	385	1	627141000*
18	460	385	1	627142000*
20	460	385	1	627143000*
22	460	385	1	627144000*
24	460	385	1	627145000*
26	460	385	1	627146000*
28	460	385	1	627147000*
30	460	385	1	627148000*
32	460	385	1	627150000*

*Self-service packaging

01
02
03
04
05
06
07
08
09
10
11
12
13
14
15
16

Forstner drill bits, similar to DIN 7483 G



- Forstner drill bit, similar to DIN 7483 G with centering point, 2 main cutters and 2 ring cutters
- For use in hard and soft wood, veneered wooden boards, etc.
- Suitable for drilling blind holes.

Diameter mm	Overall length mm	Shaft Ø mm	Sales unit	Order no.
10	90	8	1	627579000*
12	90	8	1	627580000*
14	90	8	1	627581000*
15	90	10	1	627582000*
16	90	10	1	627583000*
18	90	10	1	627584000*
20	90	10	1	627585000*
22	90	10	1	627586000*
24	90	10	1	627587000*
25	90	12	1	627588000*
26	90	12	1	627589000*
28	90	12	1	627590000*
30	90	12	1	627591000*
32	90	12	1	627592000*
34	90	12	1	627593000*
35	90	12	1	627594000*
36	90	12	1	627595000*
38	90	12	1	627596000*
40	90	15	1	627597000*
45	90	15	1	627598000*
50	90	15	1	627599000*

Carbide Multi-Spur machine bit



- Precision multi-spur machine bit, similar to DIN 7483 C with centering point, 2 sharp rough cutters and 2 main cutters made of carbide steel
- For professional use and non-splintering drilling in veneered wooden boards as well as all natural hard and soft wood types

Diameter mm	Overall length mm	Shaft Ø mm	Sales unit	Order no.
20	90	8	1	625123000*
25	90	8	1	625126000*
30	90	8	1	625128000*
35	90	10	1	625129000*
40	90	10	1	625130000*

Wood drill bits with 1/4" (6.35 mm) hexagonal shank



- Wood drill bit made of high-grade steel, with centering point for high-precision spot-drilling and two side cutters for quick and non-splintering drilling in soft wood, chipboard, plywood, light construction materials etc.
- The 1/4" (6.35 mm) hexagonal shank fits into standard chucks and E 6.3 holders.

Diameter mm	Overall length mm	Sales unit	Order no.
8	160	1	627311000*
10	160	1	627312000*
12	160	1	627313000*
13	160	1	627314000*
14	160	1	627315000*
16	160	1	627316000*
17	160	1	627347000*
18	160	1	627317000*
19	160	1	627318000*
20	160	1	627319000*

*Self-service packaging

Diameter mm	Overall length mm	Sales unit	Order no.
22	160	1	627320000*
24	160	1	627321000*
25	160	1	627322000*
26	160	1	627323000*
28	160	1	627324000*
30	160	1	627325000*
32	160	1	627326000*
36	160	1	627327000*
38	160	1	627328000*

Extension for wood drill bit

Working length mm	Sales unit	Order no.
305	1	627329000*

Drill bit assortments for metal, stone, wood

Order no.
627179000*
627190000



Drill bit assortment
Stone, wood and HSS-R drill bit, 9 pieces, in plastic storage case
each 3 x Ø 5 / 6 / 8 mm



Drill bit assortment
Stone, wood and HSS-R drill bit, 18 pieces, in plastic storage case
each 1 x Ø 3 / 4 / 5 / 6 / 8 / 10 mm



Accessory sets can be found in chapter 31, from page 288

Hole saws

»Pionier« Multipurpose hole saw, carbide tipped, with M 16 female thread





- Carbide teeth supported on both sides and enlarged brazed contact areas guarantee a secure fit and a high-strength connection of material.
- Improved vibration characteristics by means of the special curved geometry of the enlarged chip room and the clean-out slot.
- Ideal for electricians, tile layers, sanitation installers, heater contractors, cabinet makers, kitchen studios, artisans
- For solid wood, plywood, chipboard, plastics, acrylic glass, tiles (up to scratch hardness 6), plaster concrete blocks, aerated concrete, wood-wool boards, fibre cement, solid brick
- Maximum cutting depth 60 mm
- Only use in rotary mode, turn off impact. Use hole saws only with arbor and pilot drill.



Diameter mm	Order no.
25	627001000*
30	627002000*
35	627003000*
40	627004000*
50	627005000*
60	627006000*
63	627007000*
65	627008000*
68	627009000*
74	627010000*
80	627012000*
105	627013000*

Arbors for multi-purpose hole saws »Pionier«

- Comfortable quick fastener for a fast change of the centre drill, without setscrew.
- No tool loss in the event of accidentally switched-on impact mechanism: the shortened holding slots prevent impact operation on the hammer drills with SDS-plus holder, thereby not damaging the tool.
- For working with the multi-purpose hole saws »Pionier«
- Easy removal of the drilling core by unlocking the pilot drill and pulling out the drilling core from the hole saw.
- The spanner flats enable easy release of the adapter.

	Shaft type	Overall length mm	Order no.
	SW11	118	627037000*
	SDS-plus	118	627038000*
	SDS-plus	220	627039000*

Pilot drill, carbide-tipped

	Order no.
 Pilot drill HSS Diameter: 7.4 mm Overall length: 120 mm	627088000*
 Pilot drill HM Diameter: 8 mm Overall length: 120 mm	627040000*

NEW

Bi-metal hole saws







- Hole saws made of bi-metal with hardened teeth made from high-alloy high-speed steel with a cobalt content of 8%, thus significantly increased tool life
- Quicker and softer chip removal through new kind of teeth with irregular tooth shape and division; thus less vibration
- For use in cast steel and grey cast iron, stainless steel, constructional steel, aluminium, bronze, copper, PVC, acrylic glass, wood.
- Maximum cutting depth approx. 35 mm
- Thread for hole saws-Ø 14-30 mm: 1/2"-20 UNF; thread for hole saws-Ø 32-152mm: 5/8"-18 UNF
- Use hole saws only with the corresponding arbor and pilot drill.

Diameter mm	Order no.
14	625160000*
16	625161000*
17	625162000*
19	625163000*
20	625164000*
21	625165000*
22	625166000*
24	625167000*
25	625168000*
27	625169000*
29	625170000*
30	625171000*
32	625172000*
33	625173000*
35	625174000*
37	625175000*
38	625176000*
40	625177000*
41	625178000*
43	625179000*

*Self-service packaging





Diameter mm	Order no.
44	625180000*
46	625181000*
48	625182000*
51	625184000*
52	625185000*
54	625186000*
56	625187000*
57	625188000*
59	625189000*
60	625190000*
64	625191000*
65	625192000*
67	625193000*
68	625194000*
70	625195000*
73	625196000*
76	625197000*
79	625198000*
83	625199000*
86	625200000*
89	625201000*
92	625202000*
95	625203000*
98	625204000*
102	625205000*
105	625206000*
108	625207000*
111	625208000*
114	625209000*
121	625210000*
127	625211000*
140	625213000*
152	625214000*

Arbors for bi-metal hole saws







	Designation	Hole saw Ø	Shaft type	Order no.
	Adapter SW 9/ 1/2"-20 UNF	14 - 30 mm	SW9	625215000*
	Adapter SW 9/ 5/8"-18 UNF	32 - 152 mm	SW9	625216000*
	SDS-plus adapter/ 1/2"-20 UNF	14 - 30 mm	SDS-plus	625217000*
	SDS-plus adapter/ 5/8"-18 UNF	32 - 152 mm	SDS-plus	625218000*

Pilot drill

	Order no.
 Pilot drill For work with the HSS bi-metal hole saws in combination with one of the anchor-head holders: 625215000 to 625218000 Diameter: 6.35 mm	625220000*

Bi-metal hole saws, assortments		Order no.
 <p>Bi-metal hole saw set 1, 8 pieces Consisting of: Bi-metal hole saws Ø 19, 25, 38, 44, 68 and 83 mm Arbor for hole saw-Ø 14-30 mm (SW 9/ 1/2"-20 UNF) Arbor for hole saw-Ø 32-152 mm (SW 9/ 5/8"-18 UNF) Pilot drill Plastic carry case</p>		625159000*
NEW		
 <p>Bi-metal hole saw set 1, 8 pieces Consisting of: Bi-metal hole saws Ø 22, 29, 35, 44, 51 and 68 mm Arbor for hole saw-Ø 14-30 mm (SW 9/ 1/2"-20 UNF) Arbor for hole saw-Ø 32-152 mm (SW 9/ 5/8"-18 UNF) Pilot drill Plastic carry case</p>		625434000*
 <p>Bi-metal hole saw set 2, 11 pieces Consisting of: Bi-metal hole saw Ø 19, 22, 29, 35, 44, 51, 57, 64 and 68 mm Arbor for hole saw-Ø 14-30 mm (SW 9/ 1/2"-20 UNF) Arbor for hole saw-Ø 32-152 mm (SW 9/ 5/8"-18 UNF) Pilot drill Plastic carry case</p>		625435000*
Hole saw set for wood		Order no.
 <p>Hole saw With 8 interchangeable inserts Ø 25-68 mm, with pilot drill Ø 6 mm, shank Ø 10 mm</p>		623531000*

Attachments

Angle drilling and screw-driving attachment		Order no.
 <p>Angle drilling and screw-driving attachment <ul style="list-style-type: none"> Makes easy work of drilling and screw-driving in confined spaces Spindle with hexagonal recess for screwdriver bits; bit retaining bush Suitable for forward and reverse rotation Metabo quick-action coupling Gear ratio 1:1; load resistance up to 100 Nm With chuck safety bolt and hexagon nut Aperture: 43 mm Spindle thread: 1/2" - 20 UNF Spindle with hexagonal recess: 1/4" (6.35 mm) Weight: 0.5 kg</p>		631078000*
Pump attachments		Order no.
 <p>Pump attachment BPV 01 <ul style="list-style-type: none"> Self-priming Suitable for driving units with speed up to 1,800 to 2,600 /min Fitted with its pin in the chuck of the driving unit Water temperature: max. 50° C Maximum delivery rate: 1,500 l/h Maximum suction height: 2 m Maximum delivery height: 4 m Connection piece for hose: 1/2" Weight: 0.1 kg</p>		627621000*
 <p>Pump attachment BPV 03 <ul style="list-style-type: none"> Self-priming Suitable for driving units with speed up to 3,400 rpm Metabo quick-action coupling Maximum delivery rate: 3,000 l/h Maximum suction height: 4 m Maximum delivery height: 20 m Aperture: 43 mm Connection piece for hose: R 3/4" Weight: 0.6 kg</p>		627640000*
 <p>Hexagon Nut With female thread 1/2"-20 UNF; To drive the angle attachment 631078000 or the pump attachment 627640000 on a drill with a 1/2"-20 UNF threaded spindle, but no hexagon shoulder on the spindle, requires a 19 mm AF hexagon nut (SW 19) with 1/2"-20 UNF female thread.</p>		627601000*
Flexible shaft		Order no.
 <p>Flexible shaft <ul style="list-style-type: none"> Suitable for speeds of 2,000 to 5,000 rpm Length: 1.2 m Driving shaft Ø: 6 mm Collet bore: 6 mm Weight: 0.8 kg</p>		627608000*
Clamping stand and clamp		Order no.
 <p>Clamping stand <ul style="list-style-type: none"> For safe clamping of drills and impact drills as well as die grinders and the motor of the router when working with flexible shafts. Aperture Ø 43 mm. The clamp (627107000) serves for the secure fixing </p>		627354000*
 <p>Clamp <ul style="list-style-type: none"> For the secure fixing on a work table </p>		627107000*



*Self-service packaging

Drill stand

Drill stand		Order no.
 <p>Drill stand 890</p> <ul style="list-style-type: none"> The design of the feed mechanism enables the maximum drilling depth of 65 mm to be achieved with a swivelling motion Asymmetrical arrangement of the column in relation to the base plate enables the processing of larger workpieces Unlimited access to the controls of drill and drill stand by angled cantilever Adjustable depth guide <p>Inner throat: 165 mm Working stroke: 65 mm Height of column: 500 mm Column Ø: 40 mm Aperture: 43 mm Base plate: 220 x 213 mm Weight: 5.5 kg</p>		600890000

Magnetic drill stands		Order no.
 <p>Magnetic drill stand M 100</p> <ul style="list-style-type: none"> Magnet base with high holding power for safe operation Also suitable, when used in conjunction with the safety chain supplied, for working on vertical, sloping, or overhead surfaces Vertical feed driven by rack and pinion In order to position the tip of the drill bit that is fitted in the drill exactly over the punch mark on the material to be drilled, the upper part of the magnetic drill stand can be swivelled and moved sideways Power socket on the drill stand for connecting the drill directly Adjustable support to back up the stand against the high reacting forces that arise when drilling Graduated collar indicating the depth to which the hole is drilled Can be complemented with the drill B 32/3 to a magnetic drill unit with max. drill diameter 100 mm (with core hole drill). <p>Aperture: 65 mm Depth of feed: 260 mm Maximum height: 650 mm Magnetic force (maximum): 18,000 N Dimensions magnetic base: 110 x 220 mm Weight: 22 kg Scope of delivery: Safety chain, fastening screw G 3/4", offset screwdriver SW5 and SW8, sheet steel carry case.</p>		627100000



Machine vices

Jaw dimensions mm	Clamping width mm	Order no.
 <p>80 x 45</p>	86	612003000
 <p>100 x 58</p>	100	612001000



Accessories for Sanding/Grinding and Polishing

		Order no.
 <p>Rubber backing pad For clamping grinding media Ø 125 mm (e.g. fibre sanding discs) Dimensions: Ø 125 mm Clamping shaft Ø: 8 mm Sales unit: 1</p>		623259000*



Steel-wire brushes

Clamping shaft Ø mm	Outer Ø mm	Version	Order no.	
 <p>Steel-wire wheel brush, stainless steel crimped</p> <ul style="list-style-type: none"> For light surface processing and deburring work in all metal processing For processing profiles, weld seams, cutting edges, gear wheels, grooves, narrow surfaces Edging type: crimped stainless steel wire 	6	75	Crimped	630550000*
	6	100	Crimped	630551000*
 <p>Steel-wire cup brushes, crimped steel</p> <ul style="list-style-type: none"> For light surface processing and deburring work in all metal processing For processing larger areas, weld seams, metal plates 	6	50	Crimped	626790000*
	6	75	Crimped	630552000*
 <p>Steel-wire Busby-end brush, crimped steel</p> <ul style="list-style-type: none"> For light surface processing and deburring work in all metal processing For processing hard to reach spots and inner surfaces 	6	25	Crimped	630554000*

Accessories for dust extraction

		Order no.
 <p>Vacuum cleaner adapter DDE 14</p> <ul style="list-style-type: none"> Vacuum cleaner adapter for extracting drilling dust at the hole entry point Safe and dust-free drilling in walls and ceilings By virtue of the 2-chamber system and the foam rubber gasket it stays attached to almost all (even uneven) surfaces, such as plaster, natural stone and woodchip wallpaper. Minimal drill dust residue at walls and wallpapers. The adapter is put on the existing suction hose. The negative pressure of the vacuum cleaner keeps the adapter to the respective subsurface. <p>Drill Ø: 4 - 14 mm</p>		630829000*
 <p>Vacuum cleaner adapter DDE 72</p> <ul style="list-style-type: none"> Vacuum cleaner adapter for extracting drilling dust at the hole entry point Safe and dust-free drilling in walls and ceilings By virtue of the 2-chamber system and the foam rubber gasket it stays attached to almost all (even uneven) surfaces, such as plaster, natural stone and woodchip wallpaper. Minimal drill dust residue at walls and wallpapers. The adapter is put on the existing suction hose. The negative pressure of the vacuum cleaner keeps the adapter to the respective subsurface. <p>Drill Ø: 72 mm</p>		631343000*

Other accessories for drills and impact drills

		Order no.
 <p>Side handle Standard version Diameter of aperture: 43 mm</p>		631052000*
 <p>Side handle, long Long version, especially suitable for working with tools with high torque; with locking screw to prevent slipping off the tool collar Diameter of aperture: 43 mm</p>		631074000*
 <p>Reducing bush 1/2"-3/8" for drills and impact drills</p>		630704000

*Self-service packaging

Which magnetic core drill for which application?

	MAG 32 Order no. 600635500	MAG 50 Order no. 600636500	B 32/3 Order no. 600323000	M 100 Order no. 627100000
Bit retainer				
Weldon direct chuck 19 mm (3/4") with automatic internal cooling	•	•		
MK 2 chuck		•		
MK 3 chuck				•
Application				
Drilling with core drills	■■■	■■■	■■■	■■■
Drilling with spiral drills	■■■	■■■	■■■	■■■
Working with countersinks	■	■■■	■	■
Threaded drill	-	■■■	-	-

Application: ■ suitable ■■ very suitable ■■■ optimum Equipment: • present ○ optional

01
02
03
04
05
06
07
08
09
10
11
12
13
14
15
16

HSS core drills, short



- With Weldon shank 19 mm (3/4")
- Insert only with suitable centering pin
- Suitable for steel, cast steel, non-ferrous metals and alloys

Diameter mm	Overall length mm	Working length mm	Order no.
12	64	30	626500000*
13	64	30	626501000*
14	64	30	626502000*
15	64	30	626503000*
16	64	30	626504000*
17	64	30	626505000*
18	64	30	626506000*
19	64	30	626507000*
20	64	30	626508000*
21	64	30	626509000*
22	64	30	626510000*
23	64	30	626511000*
24	64	30	626512000*
25	64	30	626513000*
26	64	30	626514000*
27	64	30	626515000*
28	64	30	626516000*
29	64	30	626517000*
30	64	30	626518000*
31	64	30	626519000*
32	64	30	626520000*

HSS core drills, long



- With Weldon shank 19 mm (3/4")
- Insert only with suitable centering pin
- Suitable for steel, cast steel, non-ferrous metals and alloys

Diameter mm	Overall length mm	Working length mm	Order no.
12	90	55	626521000*
13	90	55	626522000*
14	90	55	626523000*
15	90	55	626524000*
16	90	55	626525000*
17	90	55	626526000*
18	90	55	626527000*
19	90	55	626528000*
20	90	55	626529000*
21	90	55	626530000*
22	90	55	626531000*
23	90	55	626532000*
24	90	55	626533000*
25	90	55	626534000*
26	90	55	626535000*
27	90	55	626536000*
28	90	55	626537000*
29	90	55	626538000*
30	90	55	626539000*
31	90	55	626540000*
32	90	55	626541000*

Carbide core drills



- Core drill Ø 14 - 60 mm with Weldon shank 19 mm (3/4")
- Core drill as of Ø 70 mm with Weldon shank 32 mm (1 1/4")
- Insert only with suitable centering pin
- Also suitable for higher alloyed steels

Diameter mm	Overall length mm	Working length mm	Order no.
14	90	55	626571000*
15	90	55	626572000*
16	90	55	626573000*
17	90	55	626574000*
18	90	55	626575000*
19	90	55	626576000*
20	90	55	626577000*
21	90	55	626578000*
22	90	55	626579000*
23	90	55	626580000*
24	90	55	626581000*
25	90	55	626582000*
26	90	55	626583000*
27	90	55	626584000*
28	90	55	626585000*
29	90	55	626586000*
30	90	55	626587000*
31	90	55	626588000*
32	90	55	626589000*
33	90	55	626590000*
34	90	55	626591000*
35	90	55	626592000*
36	90	55	626593000*
37	90	55	626594000*
38	90	55	626595000*
39	90	55	626596000*
40	90	55	626597000*
45	90	55	626598000*
50	90	55	626599000*
60	90	55	626614000
70	90	55	626616000
80	90	55	626618000
90	90	55	626620000
100	90	55	626622000

Core drill bit assortments



- HSS core drill set 3 pieces**
- Suitable for steel, cast steel, non-ferrous metals and alloys
- Core drills Ø 14/18/22 mm
30 mm working length, Weldon shank 19 mm (3/4")
including centering pin



Order no.
626623000







- HSS core drill set 6 pieces**
- Suitable for steel, cast steel, non-ferrous metals and alloys
- Core drill bits Ø 14/16/18/20/22/26 mm
30 mm working length, Weldon shank 19 mm (3/4")
including centering pin

626624000

*Self-service packaging





Centering pins		Order no.
	Centering pin for HSS short For HSS core drill bits with a 30 mm working length Diameter: 6.35 mm Overall length: 75 mm	626608000*
	Centering pin for HSS long and carbide For HSS core drill bits with a 55 mm working length For carbide core drill bits up to Ø 60 mm Diameter: 6.35 mm Overall length: 100 mm	626609000*
	Centering pin for carbide For carbide core drill bits Ø 70 - 100 mm Diameter: 8 mm Overall length: 120 mm	626610000*

Industrial holders		Order no.
	Industrial holder MK2 With automatic interior cooling For the MAG 50 For the B 32/3 only in conjunction with the reducing sleeve MK 3 / MK 2 (635143000) Drill spindle holder: Morse arbor MK 2 Tool holder: Weldon shaft 19 mm (3/4")	626602000*
	Industrial holder MK3 With manual interior cooling For the B 32/3 and carbide core drill Ø 70-100 mm Drill spindle holder: Morse arbor MK 3 Tool holder: Weldon shaft 32 mm (1 1/4")	626603000
	Quick change system Simple and fast change of core drill without additional tools With automatic interior cooling For the MAG 50 For the B 32/3 only in conjunction with the reducing sleeve MK 3 / MK 2 (635143000) Drill spindle holder: Morse arbor MK 2 Tool holder: Weldon shaft 19 mm (3/4")	626604000

Adapter		Order no.
	Adapter for Weldon to Fine Quick IN Incl. centering pin (overall length: 120 mm; Ø 6.35 mm) Drill spindle holder: Weldon shaft 19 mm (3/4") Tool holder: Fine QuickIN	626600000*
	Chuck adapter Weldon 19 mm (3/4") to 1/2" - 20 UNF Drill spindle holder: Weldon shaft 19 mm (3/4") Tool holder: 1/2" - 20 UNF	626611000*

Cooling lubricant		Order no.
	Universal cutting spray <ul style="list-style-type: none"> Extended service life for tools like e.g. core drill Greater cutting speeds thanks to optimum cooling properties Core drilling: use of cutting spray with overhead work, in horizontal position of MAG or when using the B 32/3 without automatic interior cooling 	626606000

*Self-service packaging

Stirrer paddles		Order no.
	Type RS-R3 right spiral – mixing action from bottom to top <ul style="list-style-type: none"> Ideal for heavy and viscous materials Mixing action from bottom to top, agitator screws into the material by itself, bottom ring protects the container Particularly suited for all types of mortar, cement and lime plaster, adhesive binders, screeds, tile adhesive, quartz-filled epoxy resins, thermal insulation plaster, concrete, bitumen thick coating, etc. 	
Diameter mm	Length mm	Maximum material quantity kg
120	590	15 - 25
140	590	25 - 40
160	590	30 - 60
		Shaft type
		M 14
		Order no.
		626734000*
		626735000*
		626736000*
	Type RS-R2 right spiral – mixing action from bottom to top <ul style="list-style-type: none"> Ideal for all sticky and viscous materials Mixing action from bottom to top, agitator screws into the material by itself, bottom ring protects the container Particularly suited for tile adhesive and construction adhesive, finished mortar and plaster, putties, screed, epoxy resin mixture, adhesive mortars etc. 	
Diameter mm	Length mm	Maximum material quantity kg
100	590	10 - 15
120	590	10 - 15
140	590	15 - 30
		Shaft type
		Hexagon 13 mm
		M 14
		M 14
		Order no.
		626737000*
		626738000*
		626739000*
	Type RS-L2 left spiral – mixing action from top to bottom <ul style="list-style-type: none"> Ideal for runny materials Mixing action from top to bottom, the spirals push the material from top to bottom, bottom ring protects the container Particularly suited for paint, varnish, base coats, slightly creamy plasters, thin coatings, paste, casting compounds, dispersion adhesives Stirrer cage geometry and spiral optimised for splash-free working of runny materials 	
Diameter mm	Length mm	Maximum material quantity kg
80	400	5 - 10
120	590	20 - 30
		Shaft type
		Hexagon 10 mm
		M 14
		Order no.
		626744000*
		626745000*
	Type RB 4, mixing without air pockets <ul style="list-style-type: none"> Ideal for all viscous materials which normally tend to cluster into lumps Impellers of the whisks generate a high vacuum and effectively prevent the addition of air to the mixture Particularly suited for self-levelling filler and levelling mixes, as well as adhesives and sealants, bitumen coatings, putty, epoxy resin coatings etc. ... 	
Diameter mm	Length mm	Maximum material quantity kg
120	590	15 - 25
		Shaft type
		M 14
		Order no.
		626741000*
	Type SR 12 paddles – mixing action from top to bottom <ul style="list-style-type: none"> Ideal for all liquid and self-levelling materials Mixing action from top to bottom, the spirals push the material from top to bottom, bottom ring protects the container Quick and homogenous mixing of runny materials Particularly suited for the preparation of thin bed mortar for bonding blocks 	
Diameter mm	Length mm	Maximum material quantity kg
120	590	20 - 40
150	590	40 - 65
		Shaft type
		M 14
		M 14
		Order no.
		626742000*
		626743000*

*Self-service packaging

Screwdriver bits with 1/4" (6.35 mm) hexagonal shank

Screwdriver bits, torsion

- Screwdriving bits made from molybdenum vanadium steel (S2 quality) for high durability and forced closure with the screws
- The torsion zone permits to equalise torque peaks, since it absorbs forces and vibrations during the screwdriving process. High force load possible; prevents from premature breakage.
- 1/4" hex drive

Bit size	Overall length mm	Sales unit	Order no.
Phillips screwdriver bits, torsion			
			
NEW			
1	25	3	628513000*
2	25	3	628514000*
3	25	3	628515000*
2	49	3	628516000*

Bit size	Overall length mm	Sales unit	Order no.
Pozidriv screwdriver bits, torsion			
			
NEW			
1	25	3	628517000*
2	25	3	628518000*
3	25	3	628519000*
2	25	3	628520000*

Bit size	Overall length mm	Sales unit	Order no.
Bits for Torx screws, Torsion			
			
NEW			
T10	25	3	628521000*
T15	25	3	628522000*
T20	25	3	628523000*
T25	25	3	628524000*
T30	25	3	628525000*
T40	25	3	628526000*
T50 for Power X3	35	2	625419000*
T10	89	1	628527000*
T15	89	1	628528000*
T20	89	1	628529000*
T25	89	1	628530000*
T30	89	1	628531000*
T40	89	1	628532000*

Screwdriver bits, diamond



- Screwdriving bits made from chrome vanadium steel (S2 quality) for high durability and forced closure with the screws
- Special diamond coating for extremely safe fit in the screw. Reduction of the "come out" effect, thus significantly reduced workload
- The torsion zone permits to equalise torque peaks, since it absorbs forces and vibrations during the screwdriving process. High force load possible; prevents from premature breakage.
- 1/4" hex drive

Bit size	Overall length mm	Sales unit	Order no.
Phillips screwdriver bits, diamond			
			
NEW			
1	25	3	628500000*
2	25	3	628501000*
3	25	3	628502000*



Bit size	Overall length mm	Sales unit	Order no.
Pozidriv screwdriver bits, diamond			
			
NEW			
1	25	3	628503000*
2	25	3	628504000*
3	25	3	628506000*

Bit size	Overall length mm	Sales unit	Order no.
Bits for Torx screws, diamond			
			
NEW			
T10	25	3	628507000*
T15	25	3	628508000*
T20	25	3	628509000*
T25	25	3	628510000*
T30	25	3	628511000*
T40	25	3	628512000*

Screwdriver bit sets





	Order no.
 Phillips bits Consisting of Phillips bits, PH 1, PH 2 and PH 3(1 each)	628537000*
 Pozidriv bits Consisting of Pozidriv bits, PZ 1, PZ 2 and PZ 3 (1 each)	628538000*
 Bits for Torx screws Consisting of 1 bit each for Torx screws size T15, T20 and T25	628539000*







Screwdriver bit assortments, impact-proof

	Order no.
 Bit box impact 29 Consisting of: Pozidriv bits, sizes 2, 3 (torsion bits, 1 each size), 29 mm long for Torx screws, one bit each of size T 15, 20, 25, 30, 40 (torsion bits); 29 mm long 1 Bit holder Ideal for powerful drill/screwdrivers and impact drivers and wrenches	628849000*
 Bit box impact 49 Consisting of: Pozidriv bits PZ, sizes 2, 3 (torsion bits, 1 each size), 49 mm long for Torx screws, one bit each of size T 15, 20, 25, 30, 40 (torsion bits); 49 mm long Ideal for powerful drill/screwdrivers and impact drivers and wrenches	628850000*







Accessory sets can be found in chapter 31, from page 288



Bit holders		Order no.
	Bit holder, magnetic With 1/4" (6.35 mm) hexagonal shank Magnetic bit holder with quick change function, for all standard screwdriver bits Overall length: 60 mm	628540000*
NEW		
	Bit holder, magnetic With 1/4" (6.35 mm) hexagonal shank Magnetic universal bit holder for all standard screwdriver bits Overall length: 52 mm	628541000*
NEW		
	Bit holder with permanent magnet With 1/4" (6.35 mm) hexagonal shank Bit holder with permanent magnet for all standard screwdriver bits Overall length: 52 mm	628542000*
NEW		
	Bit holders With 1/4" (6.35 mm) hexagonal shank Bit holder, non-magnetic with snap ring for all standard screwdriver bits Overall length: 52 mm	628543000*
NEW		



Adapter and extensions		Order no.
	Socket wrench extension 3/4" impact-proof Overall length: 150 mm	628828000*
NEW		
	Socket wrench extension 1/2" impact-proof Overall length 150 mm	628832000
	Adapter 1/4" to 1/2", impact-proof Adapter 1/4" male hexagon to 1/2" male square Overall length: 72 mm	628838000*
NEW		
	Connector 1/4" Overall length: 50 mm	628544000*
	Adapter 3/4" to 1/2", impact-proof Adapter with 3/4" internal square on the machine side and 1/2" hexagon recess for impact-proof tools with 3/4" shank	628829000
NEW		
	Adapter 1/2" to 1/4", 3 pieces, impact-proof Impact adapter 3 pieces (incl. safety ring and pin) with 1/2" internal square on the machine side and 1/4" hexagon recess for impact-proof tools with 1/4" shank	628837000*
NEW		

Hexagonal socket wrench inserts 1/4" (6.35 mm) hexagon

	<ul style="list-style-type: none"> For screwdrivers and impact drivers with 1/4" holder Magnetic and impact-proof Made from chrome-vanadium steel, matt satin 		
Holder	Overall length mm	Key width	Order no.
1/4" (6.35 mm) hexagonal shank	65	8 mm	628843000*
1/4" (6.35 mm) hexagonal shank	65	10 mm	628845000*
1/4" (6.35 mm) hexagonal shank	65	13 mm	628847000*

Socket wrench sets		Order no.
	Socket wrench set 1/2" (10 pieces) Consisting of 10 socket wrenches (10, 11, 12, 13, 15, 17, 19, 21, 22, 24 mm)	628831000
	Socket wrench set 1/2" (3 pieces) Consisting of 3 socket wrenches (17, 19, 21mm) For alloy wheel caps, long version	628833000
	Socket wrench set 3/4" (8 pieces) Consisting of 8 socket wrenches (21, 22, 24, 26, 27, 28, 30, 32 mm)	628834000
	Socket wrench set 1" (8 pieces) Consisting of 8 socket wrenches (24, 27, 30, 32, 33, 34, 36, 38mm) Deep version	628835000

Screw-type angle attachments		Order no.
	Screw-type angle attachment <ul style="list-style-type: none"> For inserting screws more easily into places difficult to reach Suitable for cordless screwdrivers up to a maximum of 14 Nm and a maximum of 400 rpm Width across corners only 30 mm Magnetic bit holder With 1/4" (6.35 mm) hexagonal shank Gears made of special steel Suitable for forward and reverse rotation Screw-type angle attachment with 105° inclination 	630442000*
	Screw-type angle attachment <ul style="list-style-type: none"> Screw-type angle attachment for professional use. Suitable for cordless screwdrivers up to a maximum of 57 Nm and a maximum of 2,000 rpm Width across corners only 50 mm Bit holder with quick-action coupling With 1/4" (6.35 mm) hexagonal shank Gears made of special steel Suitable for forward and reverse rotation Support handle adjustable to 12 positions with lockable push-button Screw-type angle attachment with 105° inclination For inserting screws more easily into places difficult to reach 	630463000*

Screwdriver magazine with accessories		Order no.
	Screwdriver magazine SM 5-55 <ul style="list-style-type: none"> Robust screwdriver magazine for Metabo drywall screwdriver For inserting screws accurately in quick succession Standard 50-screw strips can be used For affixing screws 25-55 mm in length, maximum screw head Ø of 9.5 mm and maximum shaft Ø 5 mm Precision adjustable screw depth Screwdriver magazine removable for single-screw application Standard equipment: 2 x bits PH 2 x 180 mm suitable for: SE 2500 (620044), SE 4000 (620045), SE 6000 (620046), SE 18 LTX 2500 (620047), SE 18 LTX 4000 (620048), SE 18 LTX 6000 (620049)	631618000
	2 Bits PH 2 / 180 mm <ul style="list-style-type: none"> Suitable for screwdriver magazine SM 5-55 Phillips bits Bit size: 2 Overall length: 180 mm Sales unit: 2	631582000

*Self-service packaging

Suitable for any application

- Extensive new range of circular saw blades for all applications
- Uniform differentiation thanks to colour coding system
- In "professional" and "classic" qualities



"professional"

- Maximum cutting quality
- Particularly long service life
- Low noise and reduced vibrations



"classic"

- Solid blade
- Good cutting results

cordless cut wood

- Maximum runtime for cordless saws thanks to extra-thin cutting width and steel blade thickness
- Increased number of cuts per battery pack charge
- In "professional" and "classic" qualities

power cut wood





- For quick, coarse and medium-fine cuts
- In "professional" and "classic" qualities

precision cut wood

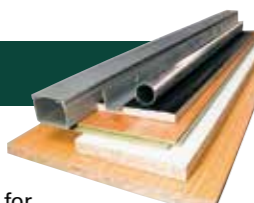

- For very good, clean cutting results for longitudinal or cross-cuts
- In "professional" and "classic" qualities

multi cut



- Universal use for demanding materials
- Perfect cutting results
- In "professional" and "classic" qualities

steel cut



- Universal use for cold cuts in metals
- Particularly suited for use in sheet steel, steel profiles and sandwich materials
- "Classic" quality

aluminium cut





- Perfect cuts in aluminium thanks to special tooth geometry
- "Professional" quality

fibercement cut





- Especially for use in cement and gypsum-bound fibre and chipboards
- Very long service life and high cutting quality thanks to PCD teeth
- "Professional" quality

laminat cut

- Perfect cuts in laminate thanks to special tooth geometry
- Reduction of vibration and noise thanks to laser ornaments
- "Professional" quality

Technical characteristics of the circular saw blades

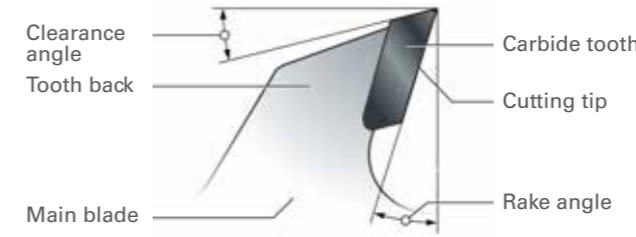

The rake angle
The rake angle influences the cut quality, feed and cutting forces. It always correlates to the desired entry and exit angles to the workpiece.

The size of the front rake angle depends on:

- The material to be processed (front rake angle decreasing: soft wood - hard wood - chip materials - non-ferrous metals)
- The respective cutting quality required on one or both edges



Positive and negative rake angle
Positive rake angle:

- Easy cutting action - fast cutting
- Cutting power in the direction of the workbench (hand-held circular saw)
- Workpiece edge: clean on the underside, without splinter guard poor on the upside

Negative rake angle:

- More difficult cutting process - higher cutting power required from machine
- Cutting force in the direction of the workpiece support (mitre saws)
- Workpiece edge on the upper side better than on the underside



The clearance angle
If the clearance angle is too low, chip removal by the next tooth is not possible. A large clearance angle facilitates large chip removal. This is necessary for greater feeds.

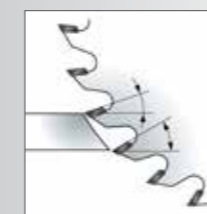

Entry and exit angles on the workpiece
In most cases, the exit angle is unfavourable as opposed to the entry angle. For this reason the "good side" should be positioned upside down.

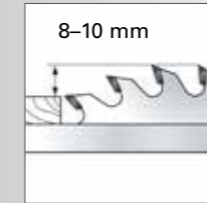

Saw blade projection
With increasing saw blade projection, the quality on the exit side decreases. It does not however improve on the entry side due to the lack of guidance effect. The ideal saw blade projection is between 8 and 10 mm.

Steel blade thickness

- Thinner blades are suited for thinner materials and require less power. Ideal for cordless applications.
- Thicker blades are particularly stable and are therefore suited for precise cuts in thicker materials on powerful saws.



Tooth shapes on the circular saw blades



WZ alternately bevel-ground tooth

- Exceptionally clean cuts in all softwoods and hardwoods, wood-fibre, laminate and plastic materials
- Easy to sharpen.
- With negative rake angle: Use on mitre saws



FZ flat tooth

- Ideal for fast and coarse lengthwise cuts in solid wood
- Simple to maintain



FZ/TZ flat/trapezoid tooth

- Ideal for aluminium, copper and brass facing, plastic, coated chipboard and MDF boards and other wooden materials
- Very clean cuts
- With negative rake angle: Use on mitre saws



FZ/FA flat tooth/chamfered flat tooth

- Used primarily for construction site and table saws, but also for high-output hand-held circular saws
- Perfectly suited for construction wood, plywood boards (also with nails and concrete residue), chipboards
- Extremely robust teeth



DZ/HZ roof/hollow tooth

- Ideal for boards coated on both sides
- Very precise and splinter-free cuts



PCD

- Diamond mounted for very long tool life
- PCD teeth exclusively in "fibercement cut" circular saw blades



SP/NV pointed tooth, KV wolf tooth

- Used for construction site saws and log cutting saws or high-performance table saws
- Tooth shape only with circular saw blades made from chrome-vanadium steel

Which circular saw blade is suited to which machine?

	Ø	Ø Bo		Ø	Ø Bo		Ø	Ø Bo		Ø	Ø Bo
AEG			DeWalt			Hitachi					
KS 55-2	165	20	DWE560	184	16	C6DA, FC6DA	160	20	5903 R, 5900/BR, SR 2300, DHS900Z	235	30
KS 66-2, KS 12-1, KS 15-1, BKS 18 BL	190	30	DCS373	140	20	C6MEY, C6 BUM/U3	165	20	5143 R	250	30
PS 216 L	216	30	DW 351	152	20	FC7SA, PSM-7, PSU-7, C 7BU2/7U2/7MFA, C7 BU3/ BUM/U3, C7U2	190	30	5103R, HS0600	270	30
TS 250 K; PS 254 L	254	30	DC 930KA/KB, DCS 931N/ NT, DWS 520 K/ KR, DWE 550, DCS 520NT/T2, DCS391, DCS520	165	20	C8U/FA, C8FC, CSU, CU8, PSM-8, PSU-8	210	30	LH1200FL, LH 1201 FL, LS1216LB	305	30
PS 305 DG	305	30	D23650, DW 365/65/2365K, DWE575K, DWE576K, DCS 575 T2/NT, DCS 576 T2/NT	190	30	C8FAFC/FS, C 8FSHE	216	30	5100 BR, 2712	315	30
Alko											
Pro 250 GK	250	20	DCS 7485	210	30	C 12 LCH, C 12 YA/YB, C 12 LSH, C12 RSH2	305	30	MS 1400	350	30
Pro-X, Holzmeister H/S/ NHS, Hobby, Basic, HS/3/4	315	30	DW 700/701/707/712/770/ 771/777, DCS 777 T2/N, DWS 773/774/777	216	30	PSU13	315	30	Milwaukee		
W 450/500	450	30	DW 383, D 23700	235	30				M12 CCS44		
W 50 Profil	500	30	DW125/1251/150/1501/1503/ 250/252/320/702/703/710/ 717/717XPS/720/742/743/ 743N/744/745/746/S778/ 744XP/745, DWS778, DCS 778 T2/N	250	30				M18 FMCS		
RM 60, W 60	600	30	1875, 2151, 2154, 2155, 1635-3L-4L, 21553 3L, DW1370/160DS/305/ 8001/8002/8003, 142 DS, 160 DS, 1635, DW 810, DW 721/721KN/722/725/ 726/8101/8012/8103	300	30				CS 55		
RM 70, R Z70, TWM 70, TWZ 70, W 70	700	30	DW704/705/706/708/716/ 716 E/718, D27105/27107/ 27107XPS/27111/27112/ 27113, DWS780, DHS 780 T2A	305	30				HD28 MS		
Atika											
KGSZ 210	210	30	D27400	315	30				SCS 65 Q, M18 CCS66, M18 FCS66, M18 BLCS66, M18 FCSRH66, M18 FCSG66		
Toptronic, PTK 250 S	250	30	DW1420S/1600S/729KN	350	30				CS 75		
KGSZ 305	305	30	C14, 1635, 6L, 2155, 6, 163546+62, 2155-4+6, C 6K/L, BK, DA 1635	400	30				MS 216 SB, M18 SMS216		
ATK 315H, BTA 90, HAT 315, HT 315	315	30							MS 3 C, MS 305 DB		
ABH 400, ABK 400, BTK 400, BTH 400	400	30							F18 FMS 254		
BTK 450, BTH 450, BTU 450, ABH 450, ABK 450, ATU, BVK 450	450	30							MS 305 DB		
ABH 500, ABK 500, BVK 500, BTK 500, BTH 500	500	30									
BWK 600	600	30									
T 250 N, T 250 ECO, TK 250	250	30									
Atlas Copco											
SGS 66 Q, K 66 SE	190	30									
HK 75	210	30									
K 55 S	160	20									
MS 3 C	250	30									
MS 305 DB	305	30									
Avola											
LH 315, TZV 315	315	30									
ZB 400, ZBV 400	400	30									
ZB 450, ZBV 450, IC 450	450	30									
ZB 500, ZBV 550	500	30									
KWK 600, RK 600	600	30									
KWK 700	700	30									
TZH 350	350	30									
BGU											
WK 600 W, WK 600/B, KS 600	600	30									
WK 780 W, WK 700 Z, WTK 710 EZ, KS 700	700	30									
RK 775, WK 700											
Bosch											
PKS 16 Multi	65	15									
GKS 12V-26, UniversalCirc 12	85	15									
PKS 40	130	16									
PKS 18 LI	150	16									
PKS 55A	160	20									
GKT 55 GCE, GKS 18V-57 G, GKS 18 V-Li, GKS 55+ G, GKS 55+ GCE	165	20									
GKS 190, GKS 55/55 CE, GKS 65/65, GCE/66/66, PKS 66, CE/68 BC, GKS 18V-68 C, GKS 18V-68 GC	190	30									
GKS 75 S	210	30									
GCM 800 SJ/8 SDE/8 SJL, PCM 8	216	30									
GKS 85 S	230	30									
GKS 85, GKS 85 G	235	30									
GCM 10 S/SD, PTS 10, GTS 10 J/ XC	254	30									
GCM 12, 12 GDL/SDE/JL, GTM 12 JL	305	30									

"Cordless cut wood" circular saw blades

"Cordless cut wood" circular saw blades, professional quality, for circular saws



NEW

- Maximum runtime for cordless saws thanks to extra thin steel blade thickness and cutting width
- Significantly more cuts per battery pack charge compared to standard saw blades with the same long tool life
- Particularly long tool life thanks to best carbide quality and finely-ground teeth
- Precise, low-noise and vibration-minimised cuts thanks to lasered expansion slots (and partially laser ornaments) as well as lasered steel blades made from sintered steel

Diameter x cutting width x bore mm	Material	Number of teeth	Tooth shape	Steel blade thickness mm	Rake angle	Suitable for	Packaging	Order no.
160 x 1,6 x 20 / 16	HW/CT	24	WZ	1,1	22°	KSAP 18, KSA 18 LTX	Cardboard box	628030000*
165 x 1,6 x 20	HW/CT	18	WZ	1,1	20°	KS 18 LTX 57 / KT 18 LTX 66 BL / KS 18 LTX 66 BL	Cardboard box	628294000*
165 x 1,6 x 20	HW/CT	36	WZ	1,1	15°	KS 18 LTX 57 / KT 18 LTX 66 BL / KS 18 LTX 66 BL	Cardboard box	628295000*

"Cordless cut wood" circular saw blades, professional quality, for semi-stationary circular saws



NEW

- Maximum runtime for cordless saws thanks to extra thin steel blade thickness and cutting width
- Significantly more cuts per battery pack charge compared to standard saw blades with the same long tool life
- Particularly long tool life thanks to best carbide quality and finely-ground teeth
- Precise, low-noise and vibration-minimised cuts thanks to lasered expansion slots (and partially laser ornaments) as well as lasered steel blades made from sintered steel
- Secondary holder for circular saw blades with Ø 216

Diameter x cutting width x bore mm	Material	Number of teeth	Tooth shape	Steel blade thickness mm	Rake angle	Suitable for	Packaging	Order no.
216 x 1,8 x 30	HW/CT	28	WZ	1,2	5° neg.	KS 18 LTX 216 / KGS 18 LTX 216	Cardboard box	628444000*
216 x 1,8 x 30	HW/CT	48	WZ	1,2	5° neg.	KS 18 LTX 216 / KGS 18 LTX 216	Cardboard box	628445000*

"Cordless cut wood" circular saw blades, classic quality, for circular saws



NEW

- Maximum runtime for cordless saws thanks to extra thin steel blade thickness and cutting width
- Significantly more cuts per battery pack charge compared to standard saw blades with the same long tool life

Diameter x cutting width x bore mm	Material	Number of teeth	Tooth shape	Steel blade thickness mm	Rake angle	Suitable for	Packaging	Order no.
165 x 1,6 x 20	HW/CT	18	WZ	1,0	20°	KS 18 LTX 57 / KT 18 LTX 66 BL / KS 18 LTX 66 BL	Cardboard box	628272000*
165 x 1,6 x 20	HW/CT	18	WZ	1,0	20°	KS 18 LTX 57 / KT 18 LTX 66 BL / KS 18 LTX 66 BL	Bliester	628650000*
165 x 1,6 x 20	HW/CT	36	WZ	1,0	15°	KS 18 LTX 57 / KT 18 LTX 66 BL / KS 18 LTX 66 BL	Cardboard box	628279000*
165 x 1,6 x 20	HW/CT	36	WZ	1,0	15°	KS 18 LTX 57 / KT 18 LTX 66 BL / KS 18 LTX 66 BL	Bliester	628660000*

Ø Diameter in mm
Ø Bo Bore diameter in mm

* Self-service packaging

"Cordless cut wood" circular saw blades, classic quality, for semi-stationary circular saws



- Maximum runtime for cordless saws thanks to extra thin steel blade thickness and cutting width
- Significantly more cuts per battery pack charge compared to standard saw blades with the same long tool life

NEW

Diameter x cutting width x bore mm	Material	Number of teeth	Tooth shape	Steel blade thickness mm	Rake angle	Suitable for	Packaging	Order no.
216 x 1,8 x 30	HW/CT	28	WZ	1,2	5°	KS 18 LTX 216 / KGS 18 LTX 216	Cardboard box	628284000*
216 x 1,8 x 30	HW/CT	28	WZ	1,2	5°	KS 18 LTX 216 / KGS 18 LTX 216	Blister	628665000*
216 x 1,8 x 30	HW/CT	40	WZ	1,2	5°	KS 18 LTX 216 / KGS 18 LTX 216	Cardboard box	628065000*
216 x 1,8 x 30	HW/CT	40	WZ	1,2	5°	KS 18 LTX 216 / KGS 18 LTX 216	Blister	628654000*

"Power cut wood" circular saw blades

"Power cut wood" circular saw blades, professional quality for circular saws



- For coarse and semi-fine cuts with continuous feed. Ideal for high feed rate / low power consumption machines
- Good cutting results for straight cuts in solid wood
- Partially suitable for construction wood with nails and concrete residue
- Particularly long tool life thanks to best carbide quality and finely-ground teeth
- Precise, low-noise and vibration-minimised cuts thanks to lasered expansion slots (and partially laser ornaments) as well as lasered steel blades made from sintered steel

Diameter x cutting width x bore mm	Material	Number of teeth	Tooth shape	Steel blade thickness mm	Rake angle	Suitable for	Packaging	Order no.
152 x 2,4 x 20	HW/CT	12	FZ	1,6	15°	Ks 0852 S	Cardboard box	628001000*
160 x 2,2 x 20	HW/CT	10	WZ	1,4	22°	KS 54 / KSE 55 Plus / KSE 55 Vario Plus / KS 55 / KS 55 FS / KS 55 FS	Cardboard box	628002000*
160 x 2,2 x 20	HW/CT	30	WZ	1,4	5°	KS 54 / KSE 55 Plus / KSE 55 Vario Plus / KS 55 / KS 55 FS	Cardboard box	628071000*
165 x 2,2 x 20	HW/CT	14	FZ/FA	1,4	10°	KS 18 LTX 57 / KT 18 LTX 66 BL / KS 18 LTX 66 BL	Cardboard box	NEW 628292000*
190 x 2,6 x 20	HW/CT	14	WZ	1,8	25°	Ks 1266 S / Ks 1468 S	Cardboard box	628004000*
190 x 2,2 x 30	HW/CT	14	WZ	1,4	25°	KS 66 / KS 66 Plus / KSE 68 Plus / KS 66 FS	Cardboard box	628005000*
190 x 2,2 x 30	HW/CT	16	FZ/FA	1,4	12°	KS 66 / KS 66 Plus / KSE 68 Plus / KS 66 FS	Cardboard box	628006000*
210 x 2,6 x 30	HW/CT	16	FZ	1,8	25°	Ks E 1678 S-Signal	Cardboard box	628007000*
230 x 2,6 x 30	HW/CT	18	FZ/FA	1,8	10°	KS 85	Cardboard box	628010000*
230 x 2,6 x 30	HW/CT	24	WZ	1,8	20°	KS 85	Cardboard box	628011000*
235 x 2,6 x 30	HW/CT	18	FZ/FA	1,8	10°	KS 85 FS	Cardboard box	NEW 628492000*
235 x 2,6 x 30	HW/CT	24	WZ	1,8	20°	KS 85 FS	Cardboard box	NEW 628493000*

"Power cut wood" circular saw blades, professional quality, for semi-stationary circular saws



- For coarse and semi-fine cuts with continuous feed. Ideal for high feed rate / low power consumption machines
- Good cutting results for straight cuts in solid wood
- Partially suitable for construction wood with nails and concrete residue
- Particularly long tool life thanks to best carbide quality and finely-ground teeth
- Precise, low-noise and vibration-minimised cuts thanks to lasered expansion slots (and partially laser ornaments) as well as lasered steel blades made from sintered steel
- Secondary holder for circular saw blades with Ø 216, 250, 254 and over 300 mm

Diameter x cutting width x bore mm	Material	Number of teeth	Tooth shape	Steel blade thickness mm	Rake angle	Suitable for	Packaging	Order no.
216 x 2,4 x 30	HW/CT	20	WZ	1,8	5° neg.	KS 216 M Lasercut / KGS 216 M / KGSV 216 M / KGSV 72 Xact / KGSV 72 Xact SYM	Cardboard box	628230000*
216 x 2,4 x 30	HW/CT	24	WZ	1,8	5° neg.	KS 216 M Lasercut / KGS 216 M / KGS 216 Plus / KGSV 216 / KGSV 72 Xact / KGSV 72 Xact SYM	Cardboard box	628009000*
250 x 2,8 x 30	HW/CT	24	WZ	2,0	25°	PKU 250 / PK 255 / PKF 255 / PKF 255 V8 / Multi 260 / Multi 310 / PK 250	Cardboard box	628012000*
250 x 2,8 x 30	HW/CT	24	WZ	2,0	3° neg.	KS 250, KGS 301 / KGS 303 / KGS 331	Cardboard box	628013000*
254 x 2,4 x 30	HW/CT	24	WZ	1,6	20°	TS 254 / TK 250 / TS 254 M	Cardboard box	628025000*
254 x 2,4 x 30	HW/CT	24	WZ	1,8	5° neg.	KS 254 Plus / KGS 254 M / KGS 254 Plus / KGS 254 I Plus	Cardboard box	628220000*
300 x 2,8 x 30	HW/CT	28	WZ	1,8	15°	PK 300 / PKV 300 G to 1996	Cardboard box	628014000*
315 x 2,8 x 30	HW/CT	20	FZ	1,8	22°	TKHS 315 / KGT 300	Cardboard box	628015000*
315 x 3,0 x 30	HW/CT	24	WZ	2,0	20°	TKHS 315	Cardboard box	628016000*
350 x 2,8 x 30	HW/CT	22	FZ	1,8	22°	TK 350 to 1983	Cardboard box	628017000*
400 x 3,5 x 30	HW/CT	28	FZ/FA	2,5	10°	BKS 400 Plus	Cardboard box	628018000*
450 x 3,5 x 30	HW/CT	32	FZ/FA	2,5	10°	BKS 450 Plus / BKH 450 Plus	Cardboard box	628020000*
600 x 3,8 x 30	HW/CT	36	WZ	2,8		BW 600	Cardboard box	628023000*
700 x 4,2 x 30	HW/CT	42	WZ	3,2		BW 750 / BW 700 to 1993	Cardboard box	628024000*

"Power cut wood" circular saw blades, classic quality, for circular saws



NEW

- For coarse and semi-fine cuts with continuous feed. Ideal for high feed rate / low power consumption machines
- Good cutting results for straight cuts in solid wood

Diameter x cutting width x bore mm	Material	Number of teeth	Tooth shape	Steel blade thickness mm	Rake angle	Suitable for	Packaging	Order no.
235 x 2,8 x 30	HW/CT	24	WZ	2,0	18°	KS 85 FS	Cardboard box	628677000*
235 x 2,8 x 30	HW/CT	24	WZ	2,0	18°	KS 85 FS	Blister	628678000*

* Self-service packaging

"Power cut wood" circular saw blades, classic quality, for semi-stationary circular saws



- Extremely robust and durable. Especially for use in construction wood with nails and concrete residues.
- For coarse and semi-fine cuts with continuous feed. Ideal for high feed rate / low power consumption machines
- Good cutting results for straight cuts in solid wood

NEW

Diameter x cutting width x bore mm	Material	Number of teeth	Tooth shape	Steel blade thickness mm	Rake angle	Suitable for	Packaging	Order no.
400 / 30 x 3,2	HW/CT	28	TZ	2,2	15°	BKS 400 Plus	Cardboard box	628647000*
450 / 30 x 3,5	HW/CT	32	TZ	2,5	15°	BKS 450 Plus / BKH 450 Plus	Cardboard box	628648000*
500 / 30 x 3,8	HW/CT	36	TZ	2,8	15°		Cardboard box	628649000*

"Power cut wood" chrome-vanadium circular saw blades, for semi-stationary circular saws



- For coarse and semi-fine cuts with continuous feed. Ideal for high feed rate / low power consumption machines
- Good cutting results for straight cuts in solid wood
- Partially suitable for construction wood with nails and concrete residue
- On coated wood or other composites, only coarse cut quality is possible

Diameter x cutting width x bore mm	Material	Number of teeth	Tooth shape	Steel blade thickness mm	Suitable for	Packaging	Order no.
315 x 1,8 x 30	CV	56	KV	1,8	TKHS 315	Cardboard box	628100000*
315 x 1,8 x 30	CV	80	NV	1,8	TKHS 315	Cardboard box	628101000*
350 x 1,8 x 30	CV	56	NV	1,8	TK 350 to 1983	Cardboard box	628102000*
400 x 2 x 30	CV	56	KV	2,0	BKS 400 Plus	Cardboard box	628105000*
450 x 2,2 x 30	CV	56	WZ	2,2	BKS 450 Plus / BKH 450 Plus	Cardboard box	628094000*
500 x 2,5 x 30	CV	56	KV	2,5	BW 500 to 1998	Cardboard box	628108000*
600 x 2,8 x 30	CV	56	KV	2,8	BW 600	Cardboard box	628109000*
700 x 2,8 x 30	CV	56	KV	2,8	BW 750 / BW 700 to 1993	Cardboard box	628110000*

"Precision cut wood" circular saw blades

"Precision cut wood" circular saw blades, professional quality, for circular saws



- Very wide range of uses in wood processing
- For very good, clean cutting results for longitudinal or cross-cuts in softwood and hardwood
- Perfectly suited for hard wood and plywood, untreated chipboards, coated or veneered, MDF, composite materials
- High power consumption so the saw must have a high performance motor
- Particularly long tool life thanks to best carbide quality and finely-ground teeth
- Precise, low-noise and vibration-minimised cuts thanks to lasered expansion slots (and partially laser ornaments) as well as lasered steel blades made from sintered steel

Diameter x cutting width x bore mm	Material	Number of teeth	Tooth shape	Steel blade thickness mm	Rake angle	Suitable for	Packaging	Order no.
160 x 2,2 x 20	HW/CT	24	WZ	1,4	20°	KS 54 / KSE 55 Plus / KSE 55 Vario Plus, KS 55 / KS 55 FS	Cardboard box	628031000*
160 x 2,2 x 20	HW/CT	42	WZ	1,4	15°	KS 54 / KSE 55 Plus / KSE 55 Vario Plus, KS 55 / KS 55 FS	Cardboard box	628072000*
165 x 2,2 x 20	HW/CT	24	WZ	1,4	20°	KS 18 LTX 57, KT 18 LTX 66 BL, KS 18 LTX 66 BL	Cardboard box	628290000* NEW
165 x 2,2 x 20	HW/CT	42	WZ	1,4	15°	KS 18 LTX 57, KT 18 LTX 66 BL, KS 18 LTX 66 BL	Cardboard box	628291000* NEW
190 x 2,6 x 20	HW/CT	48	WZ	1,8	10°	Ks 1266 S / Ks 1468 S	Cardboard box	628034000*

* Self-service packaging

Diameter x cutting width x bore mm	Material	Number of teeth	Tooth shape	Steel blade thickness mm	Rake angle	Suitable for	Packaging	Order no.
190 x 2,2 x 30	HW/CT	48	WZ	1,4	15°	KS 66 / KS 66 Plus / KSE 68 Plus / KS 66 FS	Cardboard box	628035000*
210 x 2,6 x 30	HW/CT	56	WZ	1,8	10°	Ks E 1678 S-Signal	Cardboard box	628040000*
230 x 2,6 x 30	HW/CT	56	WZ	1,8	15°	KS 85	Cardboard box	628044000*
235 x 2,6 x 30	HW/CT	44	WZ	1,8	15°	KS 85 FS	Cardboard box	628494000*

"Precision cut wood" circular saw blades, professional quality, for semi-stationary circular saws



- Very wide range of uses in wood processing
- For very good, clean cutting results for longitudinal or cross-cuts in softwood and hardwood
- Perfectly suited for hard wood and plywood, untreated chipboards, coated or veneered, MDF, composite materials
- High power consumption so the saw must have a high performance motor
- Particularly long tool life thanks to best carbide quality and finely-ground teeth
- Precise, low-noise and vibration-minimised cuts thanks to lasered expansion slots (and partially laser ornaments) as well as lasered steel blades made from sintered steel
- Secondary holder for circular saw blades with Ø 216, 250, 254 and over 300 mm

Diameter x cutting width x bore mm	Material	Number of teeth	Tooth shape	Steel blade thickness mm	Rake angle	Suitable for	Packaging	Order no.
210 x 2,4 x 30	HW/CT	40	WZ	1,8	3°	KS 210 / KGS 255 / PK 200 / UK 220	Cardboard box	628037000*
216 x 2,4 x 30	HW/CT	48	WZ	1,8	5° neg.	KS 216 M LaserCut / KGS 216 M / KGS 216 Plus / KGSV 216 M / KGSV 72 Xact / KGSV 72 Xact SYM	Cardboard box	628041000*
220 x 2,4 x 30	HW/CT	36	WZ	1,6	10°	UK 290 / UK 333 / Secanta	Cardboard box	628042000*
220 x 2,6 x 30	HW/CT	48	DZ/HZ	1,6	10°	UK 290 / UK 333 / Secanta	Cardboard box	628043000*
250 x 2,8 x 30	HW/CT	34	WZ	1,8	15°	KGT 500 / KGT 501 / KGT 550 / PKU 250 / PK 255 / PKF 255 / PKF 255 V8 / Multi 260 / Multi 310	Cardboard box	628045000*
250 x 2,8 x 30	HW/CT	42	WZ	1,8	15°	KGT 500 / KGT 501 / KGT 550 / PKU 250 / PK 255 / PKF 255 / PKF 255 V8 / Multi 260 / Multi 310 / PK 250	Cardboard box	628046000*
250 x 2,4 x 30	HW/CT	60	WZ	1,8	5° neg.	KS 250, KGS 301 / KGS 303 / KGS 331	Cardboard box	628048000*
250 x 2,8 x 30	HW/CT	60	WZ	1,8	15°	TS 250, PKU 250 / PK 255 / PKF 255 / PKF 255 V8 / Multi 260 / Multi 310 / PK 250	Cardboard box	628049000*
254 x 2,4 x 30	HW/CT	40	WZ	1,6	20°	TS 254, TK 250, TS 254 M	Cardboard box	628059000*
254 x 2,4 x 30	HW/CT	48	WZ	1,8	5° neg.	KS 254 Plus / KGS 254 M / KGS 254 Plus / KGS 254 I Plus	Cardboard box	628221000*
254 x 2,4 x 30	HW/CT	60	WZ	1,8	5° neg.	KS 254 Plus / KGS 254 M / KGS 254 Plus / KGS 254 I Plus	Cardboard box	628222000*
300 x 2,8 x 30	HW/CT	48	WZ	1,8	15°	PK 300 / PKV 300 G to 1996	Cardboard box	628051000*
300 x 2,8 x 30	HW/CT	72	WZ	1,8	10°	PK 300 / PKV 300 G to 1996	Cardboard box	628053000*
305 x 2,4 x 30	HW/CT	48	WZ	1,8	5° neg.	KS 305 Plus / KGS 305 / KS 305 M / KGS 305 M / KGT 305 M	Cardboard box	628227000*
305 x 2,4 x 30	HW/CT	60	WZ	1,8	5° neg.	KS 305 Plus / KGS 305 / KS 305 M / KGS 305 M / KGT 305 M	Cardboard box	628228000*
305 x 2,4 x 30	HW/CT	84	WZ	1,8	5° neg.	KS 305 Plus / KGS 305 / KS 305 M / KGS 305 M / KGT 305 M	Cardboard box	628229000*
315 x 2,4 x 30	HW/CT	48	WZ	1,8	5° neg.	KGS 315 Plus	Cardboard box	628224000*
315 x 2,4 x 30	HW/CT	84	WZ	1,8	5° neg.	KGS 315 Plus	Cardboard box	628225000*
315 x 2,8 x 30	HW/CT	48	WZ	1,8	15°	TKHS 315	Cardboard box	628056000*
315 x 2,8 x 30	HW/CT	48	WZ	1,8	0°	KGT 300 / TKHS 315	Cardboard box	628057000*
315 x 2,8 x 30	HW/CT	84	WZ	1,8	10°	KGT 300, TKHS 315	Cardboard box	628058000*

"Precision cut wood" circular saw blades, classic quality, for circular saws



- Very wide range of uses in wood processing
- For clean cutting results for ripping or cross cutting in softwood and hardwood
- Suitable for hard wood and plywood, untreated chipboards, coated or veneered, MDF, composite materials
- High power consumption so the saw must have a high performance motor

NEW

Diameter x cutting width x bore mm	Material	Number of teeth	Tooth shape	Steel blade thickness mm	Rake angle	Suitable for	Packaging	Order no.
160 x 2,2 x 20	HW/CT	36	WZ	1,4	10°	KS 55 / KS 55 FS / KS 54 / KSE 55 Plus / KSE 55 Vario Plus	Cardboard box	628278000*
160 x 2,2 x 20	HW/CT	36	WZ	1,4	10°	KS 55 / KS 55 FS / KS 54 / KSE 55 Plus / KSE 55 Vario Plus	Blister	628659000*
165 x 2,2 x 20	HW/CT	36	WZ	1,4	15°	KS 18 LTX 57 / KT 18 LTX 66 BL / KS 18 LTX 66 BL	Cardboard box	628281000*
165 x 2,2 x 20	HW/CT	36	WZ	1,4	15°	KS 18 LTX 57 / KT 18 LTX 66 BL / KS 18 LTX 66 BL	Blister	628662000*
165 x 1,8 x 20	HW/CT	42	WZ	1,2	5°	KS 18 LTX 57 / KT 18 LTX 66 BL / KS 18 LTX 66 BL	Cardboard box	628026000*
165 x 1,8 x 20	HW/CT	42	WZ	1,2	5°	KS 18 LTX 57 / KT 18 LTX 66 BL / KS 18 LTX 66 BL	Blister	628027000*
190 x 2,0 x 30	HW/CT	24	WZ	1,4	15°	KS 66 / KS 66 Plus / KSE 68 Plus / KS 66 FS	Cardboard box	628675000*
190 x 2,0 x 30	HW/CT	24	WZ	1,4	15°	KS 66 / KS 66 Plus / KSE 68 Plus / KS 66 FS	Blister	628676000*
190 x 2,2 x 30	HW/CT	48	WZ	1,4	15°	KS 66 / KS 66 Plus / KSE 68 Plus / KS 66 FS	Cardboard box	628283000*
190 x 2,2 x 30	HW/CT	48	WZ	1,4	15°	KS 66 / KS 66 Plus / KSE 68 Plus / KS 66 FS	Blister	628664000*
235 x 2,8 x 30	HW/CT	40	WZ	2,0	15°	KS 85 FS	Cardboard box	628679000*
235 x 2,8 x 30	HW/CT	40	WZ	2,0	15°	KS 85 FS	Blister	628680000*

"Precision cut wood" circular saw blades, classic quality, for semi-stationary circular saws



- Very wide range of uses in wood processing
- For clean cutting results for ripping or cross cutting in softwood and hardwood
- Suitable for hard wood and plywood, untreated chipboards, coated or veneered, MDF, composite materials
- High power consumption so the saw must have a high performance motor

Diameter x cutting width x bore mm	Material	Number of teeth	Tooth shape	Steel blade thickness mm	Rake angle	Suitable for	Packaging	Order no.
216 x 2,4 x 30	HW/CT	30	WZ	1,6	22°	TS 216 / TS 216 Floor	Cardboard box	628062000*
216 x 2,4 x 30	HW/CT	30	WZ	1,6	22°	TS 216 / TS 216 Floor	Blister	628653000*
216 x 2,4 x 30	HW/CT	40	WZ	1,8	5° neg.	KS 216 M Lasercut / KGS 216 M, KGSV 216 M / KGSV 72 Xact / KGSV 72 Xact SYM	Cardboard box	628060000*
216 x 2,4 x 30	HW/CT	40	WZ	1,8	5° neg.	KS 216 M Lasercut / KGS 216 M / KGSV 216 M / KGSV 72 Xact / KGSV 72 Xact SYM	Blister	628652000*
254 x 2,4 x 30	HW/CT	40	WZ	1,6	20°	TS 254 / TS 254 M	Cardboard box	628325000*
254 x 2,4 x 30	HW/CT	40	WZ	1,6	20°	TS 254 / TS 254 M	Blister	628326000*
254 x 2,4 x 30	HW/CT	48	WZ	1,8	5° neg.	KGS 254 M	Cardboard box	628061000*
254 x 2,4 x 30	HW/CT	48	WZ	1,8	5° neg.	KGS 254 M	Blister	628656000*
305 x 2,4 x 30	HW/CT	56	WZ	1,6	5° neg.	KS 305 M / KGS 305 M / KGT 305 M	Cardboard box	628064000*
305 x 2,4 x 30	HW/CT	56	WZ	1,6	5° neg.	KS 305 M / KGS 305 M / KGT 305 M	Blister	628657000*

Circular saw blades, "Multi Cut"

"Multi cut" circular saw blades, professional quality, for circular saws



- Universal use for demanding materials
- For the highest standards in cutting quality, e.g. for laminate, thin-walled plastic, aluminium, copper and bronze materials
- Ideally suited for many interior development applications
- Perfect cutting results, also for cross-cuts in solid wood, coarse, coated or veneered chipboards, MDF
- The circular saw must have a very high performance power
- Particularly long tool life thanks to best carbide quality and finely-ground teeth
- Precise, low-noise and vibration-minimised cuts thanks to lasered expansion slots (and partially laser ornaments) as well as lasered steel blades made from sintered steel

Diameter x cutting width x bore mm	Material	Number of teeth	Tooth shape	Steel blade thickness mm	Rake angle	Suitable for	Packaging	Order no.
150 x 2,4 x 20	HW/CT	36	WZ	1,6	10°	Ks 0852 S	Cardboard box	628000000*
152 x 2,4 x 20	HW/CT	54	FZ/TZ	1,6	5° neg.	Ks 0852 S	Cardboard box	628070000*
160 x 2,2 x 20	HW/CT	54	FZ/TZ	1,4	8°	KS 54 / KSE 55 Plus / KSE 55 Vario Plus / KS 55 / KS 55 FS	Cardboard box	628073000*
165 x 2,2 x 20	HW/CT	54	FZ/TZ	1,4	5°	KS 18 LTX 57 / KT 18 LTX 66 BL / KS 18 LTX 66 BL	Cardboard box	628293000*
190 x 2,2 x 30	HW/CT	36	WZ	1,4	5°	KS 66 / KS 66 Plus / KSE 68 Plus / KS 66 FS	Cardboard box	628075000*
190 x 2,6 x 20	HW/CT	54	FZ/TZ	1,8	5° neg.	Ks 1266 S / Ks 1468 S	Cardboard box	628076000*
190 x 2,2 x 30	HW/CT	56	FZ/TZ	1,4	8°	KS 66 / KS 66 Plus / KSE 68 Plus / KS 66 FS	Cardboard box	628077000*
230 x 2,6 x 30	HW/CT	60	WZ	1,8	5°	KS 85	Cardboard box	628085000*
235 x 2,4 x 30	HW/CT	60	FZ/TZ	1,8	5°	KS 85 FS	Cardboard box	628495000*

"Multi cut" circular saw blades, professional quality, for semi-stationary circular saws



- Universal use for demanding materials
- For the highest standards in cutting quality, e.g. for laminate, thin-walled plastic, aluminium, copper and bronze materials
- Ideally suited for many interior development applications
- Perfect cutting results, also for cross-cuts in solid wood, coarse, coated or veneered chipboards, MDF
- The circular saw must have a very high performance power
- Particularly long tool life thanks to best carbide quality and finely-ground teeth
- Precise, low-noise and vibration-minimised cuts thanks to lasered expansion slots (and partially laser ornaments) as well as lasered steel blades made from sintered steel
- Secondary holder for circular saw blades with Ø 216, 250, 254 and over 300 mm

Diameter x cutting width x bore mm	Material	Number of teeth	Tooth shape	Steel blade thickness mm	Rake angle	Suitable for	Packaging	Order no.
210 x 2,4 x 30	HW/CT	64	FZ/TZ	1,6	5° neg.	KS 210 / KGS 255	Cardboard box	628082000*
216 x 2,4 x 30	HW/CT	60	FZ/TZ	1,8	5° neg.	KS 216 M Lasercut / KGS 216 M / KGS 216 Plus / KGSV 216 M / KGSV 72 Xact / KGSV 72 Xact SYM	Cardboard box	628083000*
216 x 2,4 x 30	HW/CT	64	FZ/TZ	1,6	10°	TS 216 / TS 216 Floor	Cardboard box	628063000*
220 x 2,6 x 30	HW/CT	80	FZ/TZ	1,6	10°	UK 290 / UK 333 / Secanta	Cardboard box	628084000*
250 x 2,8 x 30	HW/CT	80	WZ	1,8	10°	KGT 500 / KGT 501 / KGT 550 / TS 250 / PKU 250 / PK 255 / PKF 255 / PKF 255 V8 / Multi 260 / Multi 310	Cardboard box	628087000*
250 x 2,8 x 30	HW/CT	80	FZ/TZ	2,0	5° neg.	KGS 301 / KGS 303 / KGS 331 / KGT 500 / KGT 501 / KGT 550 / TS 250 / PKU 250 / PK 255 / PKF 255 / PKF 255 V8 / Multi 260 / Multi 310	Cardboard box	628088000*
254 x 2,4 x 30	HW/CT	80	FZ/TZ	1,6	5°	TS 254 / TK 250 / TS 254 M	Cardboard box	628093000*
254 x 2,4 x 30	HW/CT	80	FZ/TZ	1,8	5° neg.	KS 254 Plus / KGS 254 M / KGS 254 Plus / KGS 254 I Plus	Cardboard box	628223000*

* Self-service packaging

Diameter x cutting width x bore mm	Material	Number of teeth	Tooth shape	Steel blade thickness mm	Rake angle	Suitable for	Packaging	Order no.
300 x 2,8 x 30	HW/CT	96	FZ/TZ	2,2	6° neg.	PK 300 / PKV 300 G to 1996	Cardboard box	628090000*
305 x 2,8 x 30	HW/CT	96	FZ/TZ	2,0	5° neg.	KGS 305 / KS 305 Plus / KS 305 M / KGS 305 M / KGT 305 M	Cardboard box	628091000*
315 x 2,4 x 30	HW/CT	96	FZ/TZ	1,8	5° neg.	KGS 315 Plus	Cardboard box	628226000*
315 x 2,8 x 30	HW/CT	96	FZ/TZ	2,0	5° neg.	KGS 315 Plus	Cardboard box	628092000*

"Multi cut" circular saw blades, classic quality, for circular saws



NEW

- Universal use for demanding materials
- For high standards in cutting quality, e.g. for laminate, thin-walled plastic, aluminium, copper and brass materials
- Suitable for many interior development applications
- Good cutting results, also for cross-cuts in solid wood, coarse, coated or veneered chipboards, MDF
- The circular saw must have a very high performance power

Diameter x cutting width x bore mm	Material	Number of teeth	Tooth shape	Steel blade thickness mm	Rake angle	Suitable for	Packaging	Order no.
160 x 2,2 x 20	HW/CT	42	FZ/TZ	1,4	5°	KS 55 / KS 55 FS	Cardboard box	628277000*
160 x 2,2 x 20	HW/CT	42	FZ/TZ	1,4	5°	KS 55 / KS 55 FS	Blister	628658000*
165 x 2,2 x 20	HW/CT	42	FZ/TZ	1,4	5°	KS 18 LTX 57 / KT 18 LTX 66 BL / KS 18 LTX 66 BL	Cardboard box	628280000*
165 x 2,2 x 20	HW/CT	42	FZ/TZ	1,4	5°	KS 18 LTX 57 / KT 18 LTX 66 BL / KS 18 LTX 66 BL	Blister	628661000*
190 x 2,2 x 30	HW/CT	54	FZ/TZ	1,4	5°	KS 66 / KS 66 Plus / KSE 68 Plus / KS 66 FS	Cardboard box	628282000*
190 x 2,2 x 30	HW/CT	54	FZ/TZ	1,4	5°	KS 66 / KS 66 Plus / KSE 68 Plus / KS 66 FS	Blister	628663000*

"Multi cut" circular saw blades, classic quality, for semi-stationary circular saws



NEW

- Universal use for demanding materials
- For high standards in cutting quality, e.g. for laminate, thin-walled plastic, aluminium, copper and brass materials
- Suitable for many interior development applications
- Good cutting results, also for cross-cuts in solid wood, coarse, coated or veneered chipboards, MDF
- The circular saw must have a very high performance power

Diameter x cutting width x bore mm	Material	Number of teeth	Tooth shape	Steel blade thickness mm	Rake angle	Suitable for	Packaging	Order no.
216 x 2,4 x 30	HW/CT	60	FZ/TZ	1,8	5° neg.	KGSV 216 M, KS 216 M Lasercut / KGS 216 M / KGSV 72 Xact / KGSV 72 Xact SYM	Cardboard box	628066000*
216 x 2,4 x 30	HW/CT	60	FZ/TZ	1,8	5° neg.	KGSV 216 M / KS 216 M Lasercut / KGS 216 M / KGSV 72 Xact / KGSV 72 Xact SYM	Blister	628655000*
254 x 2,6 x 30	HW/CT	60	FZ/TZ	1,8	5° neg.	KGS 254 M	Cardboard box	628285000*
254 x 2,6 x 30	HW/CT	60	FZ/TZ	1,8	5° neg.	KGS 254 M	Blister	628666000*
305 x 3,0 x 30	HW/CT	80	FZ/TZ	2,2	5° neg.	KS 305 M / KGS 305 M / KGS 305 / KGT 305 M	Cardboard box	628286000*
305 x 3,0 x 30	HW/CT	80	FZ/TZ	2,2	5° neg.	KS 305 M / KGS 305 M / KGS 305 / KGT 305 M	Blister	628667000*

"Steel cut" circular saw blades

"Steel cut" circular saw blades, classic quality, for circular saws



NEW

- Universal use for cold cuts in metals
- Particularly suited for use in sheet steel, steel profiles and sandwich materials
- Ø 165 mm: Fast, low-burr cuts thanks to extra thin steel blade for a high number of cuts per battery pack charge
- Fits all standard metal saws

Diameter x cutting width x bore mm	Material	Number of teeth	Tooth shape	Steel blade thickness mm	Rake angle	Suitable for	Packaging	Order no.
165 x 1,6 x 20	HW/CT	40	FZFA/FZFA	1,2	4°	MKS 18 LTX 58	Cardboard box	628273000*
165 x 1,6 x 20	HW/CT	40	FZFA/FZFA	1,2	4°	MKS 18 LTX 58	Blister	628651000*

"Steel cut" circular saw blades, classic quality, for semi-stationary circular saws



NEW

- Universal use for cold cuts in metals
- Particularly suited for use in sheet steel, steel profiles and sandwich materials
- Fits all standard metal saws

Diameter x cutting width x bore mm	Material	Number of teeth	Tooth shape	Steel blade thickness mm	Rake angle	Packaging	Order no.
305 x 2,6 x 25,4	HW/CT	60	FZFA/FZFA	2,2	4°	Cardboard box	628668000*
355 x 3,0 x 25,4	HW/CT	72	FZFA/FZFA	2,5	4°	Cardboard box	628669000*

"Aluminium cut" circular saw blades

"Aluminium cut" circular saw blades, professional quality, for circular saws



NEW

- Perfect cuts in aluminium thanks to special tooth geometry
- Ø 160 and 165 mm: Fast, low-burr cuts thanks to extra thin steel blade for high number of cuts per battery pack charge
- Particularly long tool life thanks to best carbide quality and finely-ground teeth
- Precise, low-noise and vibration-minimised cuts thanks to lasered expansion slots (and partially laser ornaments) as well as lasered steel blades made from sintered steel

Diameter x cutting width x bore mm	Material	Number of teeth	Tooth shape	Steel blade thickness mm	Rake angle	Suitable for	Packaging	Order no.
160 x 1,6 x 20	HW/CT	48	FZ/TZ	1,2	5° neg.	KS 18 LTX 57	Cardboard box	628288000*
165 x 1,6 x 20	HW/CT	48	FZ/TZ	1,2	5° neg.	MKS 18 LTX 58 / KS 18 LTX 57 / KT 18 LTX 66 BL / KS 18 LTX 66 BL	Cardboard box	628276000*
190 x 2,2 x 30	HW/CT	52	FZ/TZ	1,8	5° neg.	KS 66 / KS 66 Plus / KSE 68 Plus / KS 66 FS	Cardboard box	628296000*

* Self-service packaging

"Aluminium cut" circular saw blades, professional quality, for semi-stationary circular saws



NEW

- Perfect cuts in aluminium thanks to special tooth geometry
- Particularly long tool life thanks to best carbide quality and finely-ground teeth
- Precise, low-noise and vibration-minimised cuts thanks to lasered expansion slots (and partially laser ornaments) as well as lasered steel blades made from sintered steel
- Secondary holder for circular saw blades with Ø 216, 254 and 305

Diameter x cutting width x bore mm	Material	Number of teeth	Tooth shape	Steel blade thickness mm	Rake angle	Suitable for	Packaging	Order no.
216 x 2,2 x 30	HW/CT	58	FZ/TZ	1,8	5° neg.	KS 18 LTX 216 / KGS 18 LTX 216 / KGSV 72 Xact / KGSV 72 Xact SYM / KGSV 216 M / KS 216 M Lasercut / KGS 216 M / KGS 216 Plus	Cardboard box	628443000*
254 x 2,4 x 30	HW/CT	72	FZ/TZ	2,0	5° neg.	KS 254 Plus / KGS 254 M / KGS 254 Plus / KGS 254 I Plus	Cardboard box	628447000*
305 x 2,6 x 30	HW/CT	84	FZ/TZ	2,2	5° neg.	KS 305 M / KGS 305 M	Cardboard box	628448000*

"Fibercement cut" circular saw blades

"Fibercement cut" circular saw blades, professional quality, for circular saws



NEW

- Especially for use in cement and gypsum-bound chipboards and fibreboards
- Very long service life and high cutting quality thanks to PCD teeth (polycrystalline diamond) compared to carbide-tipped standard saw blades
- Low noise development with fast sawing progress at the same time

Diameter x cutting width x bore mm	Material	Number of teeth	Tooth shape	Steel blade thickness mm	Rake angle	Suitable for	Packaging	Order no.
160 x 2,2 x 20	PCD	4	FZ	1,6	5°	KS 55 / KS 55 FS / KS 54 / KSE 55 Plus / KSE 55 Vario Plus	Cardboard box	628287000*
165 x 2,2 x 20	PCD	4	FZ	1,6	5°	KS 18 LTX 57 / KT 18 LTX 66 BL / KS 18 LTX 66 BL	Cardboard box	628289000*
190 x 2,2 x 30	PCD	4	FZ	1,6	5°	KS 66 / KS 66 Plus / KSE 68 Plus / KS 66 FS	Cardboard box	628297000*

"Laminate cut" circular saw blades

"Laminate cut" circular saw blades, professional quality, for semi-stationary circular saws



NEW

- Precise, clean cuts in all types of laminate flooring thanks to specially developed tooth geometry
- Particularly long tool life thanks to best carbide quality and finely-ground teeth
- Precise, low-noise and vibration-minimised cuts thanks to lasered expansion slots (and partially laser ornaments) as well as lasered steel blades made from sintered steel
- Secondary holder for circular saw blades with Ø 216, 254

Diameter x cutting width x bore mm	Material	Number of teeth	Tooth shape	Steel blade thickness mm	Rake angle	Suitable for	Packaging	Order no.
216 x 2,4 x 30	HW/CT	60	FZ/TZ	1,8	0°	KS 18 LTX 216 / KGS 18 LTX 216 / KGSV 72 Xact / KGSV 72 Xact SYM / KGSV 216 M / KS 216 M Lasercut / KGS 216 M / KGS 216 Plus	Cardboard box	628442000*
254 x 2,6 x 30	HW/CT	66	FZ/TZ	2,0	0°	KS 254 Plus / KGS 254 M / KGS 254 Plus / KGS 254 I Plus	Cardboard box	628446000*

Reducing bushes for circular saw blades



	Order no.
Reducing bush ■ Ø 20 x 1.2 x 16 mm ■ For circular saw blades with a steel blade thickness of 1.25 mm - max. 1.6 mm	623545000*
Reducing bush ■ Ø 30 x 1.2 x 16 mm ■ For circular saw blades with a steel blade thickness of 1.25 mm - max. 1.6 mm	623546000*
Reducing bush ■ Ø 30 x 1.2 x 20 mm ■ For circular saw blades with a steel blade thickness of 1.25 mm - max. 1.6 mm	623547000*
Reducing bush ■ Ø 30 x 1.2 x 25 mm ■ For circular saw blades with a steel blade thickness of 1.25 mm - max. 1.6 mm	623548000*
Reducing bush ■ Ø 30 x 1.6 x 16 mm ■ For circular saw blades with a steel blade thickness of 1.65 mm - max. 2.2 mm	623549000*
Reducing bush ■ Ø 30 x 1.6 x 20 mm ■ For circular saw blades with a steel blade thickness of 1.65 mm - max. 2.2 mm	623550000*
Reducing bush ■ Ø 30 x 1.6 x 25 mm ■ For circular saw blades with a steel blade thickness of 1.65 mm - max. 2.2 mm	623551000*



Cross cutting rails and guide rails



Cross cutting rails KFS



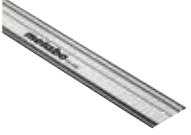
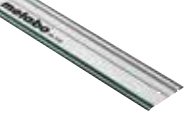

- Mobile, compact solution for angle-precise cross cuts directly at the application site, ideal on the roof or on mounted workpieces
- Can be coupled with the Metabo circular saws KS 18 LTX 66 BL, KS 18 LTX 57, KS 66 FS, KS 85 FS
- Angle cuts up to 60° click positions at standard angles
- The integrated return mechanism brings the saw back into the starting position after the cut
- Easy coupling with the circular saw thanks to quick closure
- Splinter protection reduces breakout when sawing
- Adhesive coating for safe, non-slip surface contact as well as protection of the workpiece surface

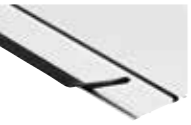
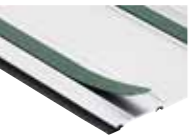

	Order no.
Cross cutting rail KFS 30 Overall length: 690 mm Cutting length: 300 mm Weight: 1,400 g	629015000*
Cross cutting rail KFS 44 Overall length: 834 mm Cutting length: 440 mm Weight: 1,640 g	629016000*
Cross cutting rail KFS 70 Overall length: 1,094 mm Cutting length: 700 mm Weight: 2,140 g	629017000*

* Self-service packaging



Guide rails FS		Order no.
<ul style="list-style-type: none"> For straight and secure guidance Splinter protection reduces breakout when sawing Adhesive coating for safe, non-slip surface contact as well as protection of the workpiece surface With bores to fix the rail to the workpiece and for hanging storage Can be extended in length with the second guide rail and FSV connector (accessory) Compatible with many circular saws of other manufacturers that are suited for use with guide rails (Hikoki, Festool, Bosch, Makita, Hilti and others) 		
	Guide rail FS 80 Suitable for Metabo hand-held circular saws Overall length: 80 cm	629010000*
	Guide rail FS 160 Overall length: 160 cm	629011000*
	Guide rail FS 160 With practical carry bag for safe storage and transport Overall length: 160 cm	629011700*
	Guide rail FS 250 Suitable for Metabo hand-held circular saws Overall length: 250 cm	629013000
	Guide rail FS 310 Overall length: 310 cm	629014000

Accessories for guide rails FS		Order no.
	Quick tensioning clamp FSSZ <ul style="list-style-type: none"> For quick and safe fixing of guide rails from Metabo and other manufacturers Solid hold even in case of vibrations Clamping height 160 mm For grooves 12 x 8 mm 	629021000*
	2 Tensioning clamps FSZ <ul style="list-style-type: none"> For safe fixing of guide rails from Metabo and other manufacturers 120 mm clamping height 	631031000*
	Connector FSV <ul style="list-style-type: none"> For the tool-free connection of two guide rails for particularly long cuts Can be pushed into the guide rail for storage Suitable for the Metabo guide rails FS 	629022000*
	Splinter protection FSS <ul style="list-style-type: none"> Reduces tears in the workpiece Roll with 3.5 m (as replacement) Suitable for the Metabo guide rails FS 	629023000*
	Sliding coating FSG <ul style="list-style-type: none"> For easy gliding on the guide rail Roll with 7 m (as replacement) 	629024000*

	Adhesive coating FSH <ul style="list-style-type: none"> For safe, non-slip hold as well as protection of the workpiece surface Roll with 7 m (as replacement) Suitable for the Metabo guide rails FS 	629025000*
	Mitre fence FSW <ul style="list-style-type: none"> For precise alignment of the guide rail on the workpiece Angle adjustable from -60° to +60° Suitable for the Metabo guide rails FS 	629026000*
	Bag FST <ul style="list-style-type: none"> Handy carry bag for safe storage and transport of the guide rail up to 160 cm Suitable for Metabo guide rails FS 160 	629020000
	Guide plate <ul style="list-style-type: none"> For use with the circular saws KSA 18 LTX, KSAP 18, KS 54 and KS 54 SP on the guide rail Complete guide plate with 2 mounted aluminium threaded bushes for the circular saws 	631019000
	Adapter <ul style="list-style-type: none"> For use with the KS 66 and KSE 68 Plus circular saws (old; order no. 600543) on the guide rail 	631020000

Guide rail 31213		Order no.
	Guide rail 31213 <ul style="list-style-type: none"> Guide rail made of sturdy, anodised aluminium extrusion Anti-slip backing provides safe and reliable support and protects the work piece surface against scratches Guide rule, adjustable to eliminate play suitable for: Metabo jigsaws, circular saws and router models OFE 738 and Of E 1229 Signal (when using the appropriate accessories; KS 55 FS, KSE 55 Vario Plus, KS 66 Plus, KSE 68 Plus can be used directly); also suitable for the CED 125 Plus dust extraction shroud in connection with an angle grinder Overall length: 1,500 mm 	631213000
	Connector <ul style="list-style-type: none"> For the trouble-free joining together of two precision guide rails Can only be used with guide rail 631213000 	631211000*

Other accessories for hand-held circular saws

Rip fence KT		Order no.
	Parallel guide / rip fence <ul style="list-style-type: none"> Double-guided aluminium parallel guide/rip fence for precise saw cut along the workpiece edge Adjustable on both sides by using scales on both guide rods Maximum workpiece width when working with parallel guide/rip fence: mounted right 185 mm, mounted left 300 mm Suitable for the cordless plunge cut circular saw KT 18 LTX 66 BL 	628029000*
NEW		
Sawdust ejection nozzle		Order no.
	Sawdust ejection nozzle <ul style="list-style-type: none"> Can be rotated For fitting the suction hose to the circular saw KS 54 and KSE 55 Plus 	630924000*

Dust bag



Dust bag

- Dust bag for working without vacuum cleaner
- Volume 1.5 l
- Suitable for circular saws KS 18 LTX 66 BL, KT 18 LTX 66 BL, KS 18 LTX 57, KS 66 FS, KS 85 FS

NEW

Order no. 628028000*

Suction hose



Suction hose Ø 27 mm

- Flexible and easy extension: extraction hose can be connected to a second one without additional connector
- Rubber connector (internal Ø 30 mm, outside Ø 35 mm)

Hose length: 3.5 m
 Hose-Ø, internal: 27 mm
 Hose-Ø, external: 33 mm
 Connection-Ø, external: 27 mm

Bayonet connection: yes
 Rotation compensation: machine side

Order no. 631938000



- Extensive range of jigsaw blades
- The right saw blade for all applications
- Concise subcategories: find the right saw blade fast
- Clear structure thanks to colour coding system

Features of the Metabo jigsaw blades

Colour coding system

The colour indicates for which material the saw blade is best suited.

wood	Wood
wood + metal	Wood with nails/metal elements
metal	Metal
carbide	*Carbide*: innovative carbide technology for excellent service life in wood and wood with nails/metal elements
expert	Special application in the field of building trade and renovation
expert carbide	Special applications in the field of building trade and renovation Very long service life thanks to carbide strip, welded-on carbide teeth or carbide mounting

Application lines

wood	wood + metal	metal	expert
»basic wood«	»universal wood + metal«	»basic metal«	»expert plastics«
»fast wood«	»carbide wood + metal«	»metal premium«	»expert plastics premium«*
»clean wood«		»metal sandwich«	»expert ceramics«*
»precision wood«		»universal metal«	»expert fiber + plaster«*
»fast wood premium«			»expert inox«*
»clean wood premium«			»expert aluminium«
»universal wood«			»expert soft materials«

*carbide

Steel blade material/saw blade teeth

- HCS** Carbon steel, for cutting soft wood, hardboards, plastics
- HSS** High yielding high-speed steel, suitable for metal, aluminium work
- BiM** Bi-metal is an especially flexible mix of HCS and HSS. The saw blades have a much higher service life than HCS and HSS and have proven their worth when there is risk of the shaft breaking
- HM/CT** Carbide: innovative carbide technology for excellent service life
Carbide strip or mounting for very long service life



- Teeth milled, offset for clearance gap**
A relatively rough cut, fast progress in cutting on hard and soft wood, aluminium, non-ferrous metals and plastics
- Teeth milled, waved for clearance gap**
A fine cut with straight tool guidance in hard and soft wood, aluminium, non-ferrous metals and plastics
- Teeth ground, offset for clearance gap**
Fast cutting in hard and soft wood
- Teeth ground, offset for clearance angle and clearance gap**
Fine and clean cut in wood and plastics

Shank forms

The jigsaw blades from Metabo are produced with all shank forms matching the jigsaws of other brand names.

Single-lug shank



U-shank



* Self-service packaging

Wood

Order no. (corresponds to Bosch type)		Material	Material to be processed	Soft wood	Hard wood	Chipboard/wood core plywood's	Plastics	Building/construction timber	Coated boards	Kitchen/worktops	Laminates	Wood + metal, wood + nails		
623631000 (T 119 B)	623646000 (T 119 BO)	623632000 (T 111 C)	HCS	For curved cuts	Fast, coarse	»basic wood«	»fast wood«	»clean wood«	»precision wood«	»fast wood premium«	»clean wood premium«	»universal wood«	»universal wood + metal«	»carbide wood + metal«
623633000 (T 144 D)	623921000 (T 144 D)	623649000 (T 244 D)	HCS	Universal, fast	Universal, fast	For curved cuts	For curved cuts	Fast, long	Extra long	For curved cuts	For curved cuts	For curved cuts	For curved cuts	For curved cuts
623654000 (T 301 CD)	623998000 (T 308 B)	623694000 (T 144 DP)	HCS	Very clean	Angle-precise	Angle precise, long	Angle-precise	Angle-precise, Extra long	Fast	Fast, long	Fast	Fast	Very clean	Universal, extra long life
623651000 (T 101 AO)	623634000 (T 101 B)	623969000* (T 101 B)	HCS	Clean	Clean	Clean								
623650000* (T 101 BR)	623635000 (T 101 D)	623923000* (T 101 D)	HCS											
623665000 (T 101 A)	623687000 (T 130 Riff)	623658000 (T 130 Riff)	BiM	Coarse	Fine	»expert fiber + plaster«	»expert inox«	»expert aluminium«	Fast	For curved cuts	Fast	Fast	Fast	Fast
623662000 (T 118 AHM)	623663000 (T 118 EHM)	623639000 (T 127 D)	HSS	Fast	For curved cuts	Fast								
623648000 (T 227 D)	623974000 (T 127 DF)	623641000 (T 113 A)	BIM	Fast	Fast	»expert soft materials«								
623670000 (T 301 CLF)	623999000 (T 308 BF)	623675000* (T 234 X)	HCS	Universal	Universal									
623949000 (T 111 HF)	623677000* (T 345 XF)	623677000* (T 367 XHM)	BiM	Universal	Universal									

01
02
03
04
05
06
07
08

Metal

Order no. (corresponds to Bosch type)		Material	Material to be processed	Steel sheets/ non-ferrous metals	Pipes/profiles	Sandwich materials	Plastics
623636000 (T 118 G)	623637000 (T 118 A)	623924000* (T 118 A)	HSS	For curved cuts	For curved cuts	Long	Long
623647000 (T 218 A)	623926000* (T 218 A)	623629000 (T 318 A)	HSS	Long			
623638000 (T 118 B)	623925000* (T 118 B)	623697000 (T 318 B)	HSS	Long			
623971000 (T 118 AF)	623950000* (T 118 AF)	623978000 (T 318 AF)	BiM	Long	Long	For curved cuts	
623604000 (T 718 BF)	623837000 (T 1018 AFP)	623676000* (T 123 XF)	BiM	Extra long	Extra long	Universal	
623670000 (T 118 EOF)	623973000 (T 118 BF)	623929000* (T 118 BF)	BiM	»metal sandwich«	»universal metal«		

Special applications

Order no. (corresponds to Bosch type)		Material	Material to be processed
623640000 (T 101 A)	623687000 (T 301 CHM)	HSS	»expert plastics«
623657000 (T 130 Riff)	623658000 (T 130 Riff)	HM	»expert ceramics«
623652000 (T 141 HM)	623671000 (T 341 HM)	Carbide, coated	»expert fiber + plaster«
623662000 (T 118 AHM)	623663000 (T 118 EHM)	HM	»expert inox«
623639000 (T 127 D)	623648000 (T 227 D)	HSS	»expert aluminium«
623641000 (T 113 A)	623684000 (T 313 AW)	BIM	»expert soft materials«

Legend

- *progressively toothed = Tooth pitch ascending suitable for both thin and thick materials
- **reversely toothed = clean cutting edges at the top, caution: deactivate the pendulum stroke!
- Highly suitable □ Only suitable under certain circumstances



Jigsaw blades with single-lug shank







"Basic wood" jigsaw blades

- Good cutting results with good tool life

Version	Material	Useable length mm	Thickness mm	Tooth pitch	Corresponds to Bosch type	Sales unit	Order no.
 Hard wood, soft wood, chipboards, wood-core plywood 2-15 mm, fibre boards 2-15 mm, plastics, insulating material							
Milled, wavy	HCS	51	1	2,0 mm/12 TPI	T 119 B	5	623631000*
 Hard wood, soft wood, chipboards, wood-core plywood 2-20 mm, fibre boards 2-20 mm, plastics, insulating material, especially for curved cuts							
Milled, wavy	HCS	51	1	2,0 mm/12 TPI	T 119 BO	5	623646000*
						25	623605000*
 Hard wood, soft wood, plastics 4-50 mm, for fast, rough cuts							
Milled, offset	HCS	74	1,25	3,0 mm/8 TPI	T 111 C	5	623632000*
						25	623606000*

"Fast wood" jigsaw blades

- Fast and straight cuts







Version	Material	Useable length mm	Thickness mm	Tooth pitch	Corresponds to Bosch type	Sales unit	Order no.
 Hard wood, soft wood, chipboards, wood-core plywood 5-50 mm, for quick cuts							
Ground, offset	HCS	74	1,25	4,0 mm/6 TPI	T 144 D	3	623964000*
						5	623633000*
						25	623690000*
						100	623712000
 Hard wood, soft wood, chipboards, wood-core plywood 5-50 mm, for quick cuts, saw blade with plunge tip							
Ground, offset	HCS	74	1,25	4-5,2 mm/6-5 TPI/ Progressive	T 144 D	5	623921000*
 Hard wood, soft wood, chipboards, wood-core plywood 5-50 mm, especially for curved cuts							
Ground, offset	HCS	74	1,25	4,0 mm/6 TPI	T 244 D	5	623649000*
						25	623607000*
 Hard wood, soft wood, chipboards, wood-core plywood 5-50 mm, especially for curved cuts, saw blade with plunge tip							
Ground, offset	HCS	74	1,25	4-5,2 mm/ 6-5 TPI/ Progressive	T 244 D	5	623960000*
 Hard wood, soft wood, chipboards, wood-core plywood 2-15 mm, fibre boards, for quick cuts							
Ground, offset	HCS	126	1,25	4,0 mm/6 TPI	T 344 D	5	623678000*
 Hard wood, soft wood, chipboards, wood-core plywood, fibre boards, construction wood, extra thick							
Ground, offset	HCS	155	1,5	4,0 mm/6 TPI	T 744 D	5	623603000*

"Clean wood" jigsaw blades

- Fast, clean and angle-precise





Version	Material	Useable length mm	Thickness mm	Tooth pitch	Corresponds to Bosch type	Sales unit	Order no.
 Soft wood, plywood, plastics 1.5-5 mm, especially for clean cuts, especially for curved cuts							
Clearance angle offset, pointed teeth	HCS	57	1,25	1,4 mm/18 TPI	T 101 AO	5	623651000*
						25	623624000*

*Self-service packaging

Version	Material	Useable length mm	Thickness mm	Tooth pitch	Corresponds to Bosch type	Sales unit	Order no.
 Hard wood, soft wood, chipboards, wood-core plywood, fibre boards, plastics 3-30 mm, for clean cuts							
Clearance angle offset, tooth ground	HCS	74	1,5	2,5 mm/10 TPI	T 101 B	3	623961000*
						5	623634000*
						25	623691000*
						100	623703000
 Hard wood, soft wood, chipboards, wood-core plywood, fibre boards, plastics 3-30 mm, for clean cuts, saw blade with plunge tip							
Clearance angle offset, tooth ground	HCS	74	1,5	2,7 mm/9 TPI	T 101 B	5	623969000*
 Hard wood, soft wood, chipboards, wood-core plywood, fibre boards, coated boards 3-30 mm, for clean cuts, Caution: deactivate the pendulum stroke!							
Clearance angle, tooth ground reverse serration	HCS	74	1,5	2,5 mm/10 TPI	T 101 BR	5	623650000*
						25	623608000*
 Hard wood, soft wood, chipboards, wood-core plywood 10-45 mm, fibre boards 10-45 mm, for clean cuts							
Clearance angle offset, tooth ground	HCS	74	1,5	4,0 mm/6 TPI	T 101 D	3	623962000*
						5	623635000*
						25	623609000*
						100	623704000
 Hard wood, soft wood, chipboards, wood-core plywood 10-45 mm, fibre boards 10-45 mm, for clean cuts, saw blade with plunge tip							
Clearance angle offset, tooth ground	HCS	74	1,5	4-5,2 mm/ 6-5 TPI/ Progressive	T 101 D	5	623923000*
 Hard wood, soft wood, chipboards, wood-core plywood 4-60 mm, fibre boards 4-60 mm, for clean cuts							
Clearance angle offset, tooth ground	HCS	91	1,5	3,0 mm/8 TPI	T 301 CD	5	623654000*
 Perfect on both sides, splinter-free cutting results, for fast cuts, soft wood, Attention: deactivate pendulum stroke!							
Clearance angle offset, tooth ground	HCS	93	1,5	2,2 mm/12 TPI	T 308 B	5	623998000*

"Precision wood" jigsaw blades

- Extremely robust thanks to extra thick saw blade
- Precise angle cuts

Version	Material	Useable length mm	Thickness mm	Tooth pitch	Corresponds to Bosch type	Sales unit	Order no.
 Hard wood, soft wood, doors, kitchen counters 5-50 mm, for precise angle cuts, extra thick, saw blade with plunge tip							
Ground, offset	HCS	74	1,7	4,0 mm/6 TPI	T 144 DP	5	623694000*
 Hard wood, soft wood, chipboards, wood-core plywood 5-100 mm, fibre boards 5-100 mm, for angle-precise cuts, extra thick							
Precision ground, tooth ground	HCS	104	1,7	4,0 mm/6 TPI	T 344 DP	5	623679000*
 Perfect, splinter-free cutting results on both sides, for fast cuts, soft wood, for angle-precise cuts, extra thick, saw blade with plunge tip							
Caution: deactivate the pendulum stroke!							
Ground, offset	HCS	91	1,7	2,2 mm/12 TPI	T 308 BP	5	623834000*
 Thick construction wood, soft wood (5-150 mm), wood-core plywood, fibre boards, for angle-precise cuts, extra thick							
Ground, offset	HCS	250	1,6	4,0 mm/6 TPI	T 1044 DP	3	623835000*





"Fast wood premium" jigsaw blades

- Fast and straight cuts with a very long service life

Version	Material	Useable length mm	Thickness mm	Tooth pitch	Corresponds to Bosch type	Sales unit	Order no.
 Hard wood, soft wood, coated boards 5-50 mm, for quick cuts							
Ground, offset	BiM	74	1,25	4,0 mm/6 TPI	T 144 DF	5	623976000*
 Hard wood, soft wood, coated boards 5-100 mm, for quick cuts							
Ground, offset	BiM	126	1,25	4,0 mm/6 TPI	T 344 DF	5	623980000*

"Clean wood premium" jigsaw blades

- Clean and precise cuts with a very long service life

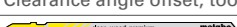
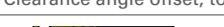
Version	Material	Useable length mm	Thickness mm	Tooth pitch	Corresponds to Bosch type	Sales unit	Order no.
 Especially for laminate, laminated flooring, hard wood, soft wood, coated boards, plywood, especially for curved cuts, for clean cuts							
Clearance angle offset, tooth ground, pointed teeth	BiM	57	1,25	1,4 mm/18 TPI	T 101 AOF	5	623695000*
 Especially for laminate, laminated flooring, hard wood, soft wood, coated boards, plastics 2-30 mm, for clean cuts							
Clearance angle offset, tooth ground, pointed teeth	BiM	74	1,25	1,7 mm/15 TPI	T 101 AIF	5	623948000*
 Hard wood, soft wood, laminated flooring, coated boards, plastics 3-30 mm, for clean cuts, saw blade with plunge tip							
Clearance angle offset, tooth ground	BiM	74	1,25	2,7 mm/9 TPI	T 101 BF	5	623975000*
 Especially for laminate, laminated flooring, kitchen counters 3-30 mm, coated boards, for clean cuts, Caution: deactivate the pendulum stroke!							
Clearance angle, tooth ground reverse serration	BiM	74	1,25	2,5 mm/10 TPI	T 101 BRF	5	623686000*
 Hard wood, soft wood, coated boards 4-60 mm							
Clearance angle offset, tooth ground	BiM	91	1,5	3,0 mm/8 TPI	T 301 CDF	5	623696000*
 Hard wood, soft wood, chipboards, plywood 5-80 mm, fibreglass boards 5-30 mm, for quick cuts							
Clearance angle offset, tooth ground	BiM	105	1,5	3,0 mm/8 TPI	T 301 CLF	5	623977000*
 Perfect on both sides, splinter-free cutting results, for fast cuts, hardwood. Attention: deactivate the pendulum stroke!							
Clearance angle offset, tooth ground	BiM	93	1,5	2,2 mm/12 TPI	T 308 BF	5	623999000*



"Universal wood" jigsaw blades

- Quick and clean in all wood thicknesses

Version	Material	Useable length mm	Thickness mm	Tooth pitch	Corresponds to Bosch type	Sales unit	Order no.
 Hard wood, soft wood, chipboards, wood-core plywood, fibre boards, for quick cuts							
Clearance angle offset, tooth ground	HCS	91	1,5	2,0-3,0 mm/12-8 TPI/ progressiv	T 234 X	5	623675000*
						25	623617000*

"Universal wood + metal" jigsaw blades

- Fast and clean into all wood strengths with metal elements

Version	Material	Useable length mm	Thickness mm	Tooth pitch	Corresponds to Bosch type	Sales unit	Order no.
 Wood, wood with nails, metal, non-ferrous metals, plastics							
Offset, milled	BiM	106	1,25	2,4-5,0 mm/10-5 TPI/ Progressive	T 345 XF	5	623677000*
						25	623621000*
 Hard wood, soft wood, wood with nails, non-ferrous metals, plastics							
Ground	BiM	90	1	2,5 mm/10 TPI	T 111 HF	5	623949000*









"Carbide wood + metal" jigsaw blades

- Welded-on carbide teeth for excellent service life
- Fast and clean cuts into the different wood and metal materials and in all material strengths

Version	Material	Useable length mm	Thickness mm	Tooth pitch	Corresponds to Bosch type	Sales unit	Order no.
 Carbide-tipped	HM	108	1	3,5-5 mm/7-5 TPI/ Progressive	T 367 XHM	3 NEW	623836000*

"Basic metal" jigsaw blades

- Good cutting results with good tool life





Version	Material	Useable length mm	Thickness mm	Tooth pitch	Corresponds to Bosch type	Sales unit	Order no.
 Steel sheets 0.5-1.5 mm, non-ferrous metals							
Milled, wavy	HSS	66	1	0,7 mm/36 TPI	T 118 G	5	623636000*
 Steel sheets 1-3 mm, non-ferrous metals							
Milled, wavy	HSS	51	1	1,2 mm/21 TPI	T 118 A	3	623965000*
						5	623637000*
						25	623692000*
 Steel sheets 1-3 mm, non-ferrous metals							
Milled, wavy	HSS	66	1	1,1-1,5 mm/23-17 TPI/progressive	T 118 A	5	623924000*
 Sheet steel 1-3 mm, non-ferrous metals, especially for curved cuts							
Milled, wavy	HSS	51	1	1,2 mm/21 TPI	T 218 A	5	623647000*
 Sheet steel 1-3 mm, non-ferrous metals, especially for curved cuts							
Milled, wavy	HSS	66	1	1,1-1,5 mm/ 23-17 TPI/progressive	T 218 A	5	623926000*
 Steel sheets 1-3 mm, non-ferrous metals, sandwich materials							
Milled, wavy	HSS	106	1	1,2 mm/21 TPI	T 318 A	5	623629000*
						25	623623000*
 Steel sheets 2.5-6 mm, non-ferrous metals							
Milled, wavy	HSS	51	1	2,0 mm/12 TPI	T 118 B	5	623638000*
						25	623618000*
 Steel sheets 2.5-6 mm, non-ferrous metals							
Milled, wavy	HSS	66	1	1,9-2,3 mm/ 13-11 TPI/progressive	T 118 B	5	623925000*
 Steel sheets 2.5-6 mm, non-ferrous metals							
Milled, wavy	HSS	106	1	2,0 mm/12 TPI	T 318 B	5	623697000*

*Self-service packaging

01
02
03
04
05
06
07
08
09
10
11
12
13
14
15
16

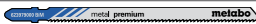

"Metal premium" jigsaw blades

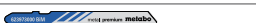
- Unbreakable with long service life

Version	Material	Useable length mm	Thickness mm	Tooth pitch	Corresponds to Bosch type	Sales unit	Order no.
 Steel sheets 1-3 mm, non-ferrous metals Milled, wavy	BiM	51	1	1,2 mm/21 TPI	T 118 AF	5	623971000*
 Steel sheets 1-3 mm, non-ferrous metals Milled, wavy	BiM	66	1	1,1-1,5 mm/ 23-17 TPI/progressive	T 118 AF	5	623950000*
 Steel sheets 1-3 mm, sandwich materials 2-65 mm, non-ferrous metals, Plexiglas Milled, wavy	BiM	106	1	1,1 mm/23 TPI	T 318 AF	5	623978000*
 Steel sheets 2.5-6 mm, sandwich materials 2-65 mm, non-ferrous metals, Plexiglas Milled, wavy	BiM	106	1	1,8 mm/14 TPI	T 318 BF	5	623979000*
 Sheet steel 1.5 - 4 mm, especially for curved cuts Milled, wavy	BiM	57	1,25	1,5 mm/17 TPI	T 118 EOF	5	623970000*
 Steel sheets 2.5-6 mm, non-ferrous metals Milled, wavy	BiM	51	1	2,0 mm/12 TPI	T 118 BF	5	623973000*
 Steel sheets 2.5-6 mm, non-ferrous metals Milled, wavy	BiM	66	1	1,9-2,3 mm/ 13-11 TPI/progressive	T 118 BF	5	623929000*

"Metal sandwich" jigsaw blades

- Especially for machining metal sandwich panels

Version	Material	Useable length mm	Thickness mm	Tooth pitch	Corresponds to Bosch type	Sales unit	Order no.
 Steel sheets 2.5-6 mm, sandwich materials 2-120 mm, non-ferrous metals, Plexiglas Milled, offset	BiM	150	1,25	2,0 mm/12 TPI	T 718 BF	5	623604000*
 Sandwich materials (<160 mm) Wavy, milled	BiM	220		1,1 mm/23 TPI	T 1018 AFP	5 NEW	623837000*

"Universal metal" jigsaw blades

- Quick and clean in all material thicknesses

Version	Material	Useable length mm	Thickness mm	Tooth pitch	Corresponds to Bosch type	Sales unit	Order no.
 Steel sheets 1.5-10 mm, non-ferrous metals to 30 mm Milled, offset	BiM	74	1	1,2-2,6mm/21-10 TPI/ Progressive	T 123 XF	5	623676000*
						25	623620000*

"Expert plastics" jigsaw blades

- For special applications: plastics
- Clean and straight cuts

Version	Material	Useable length mm	Thickness mm	Tooth pitch	Corresponds to Bosch type	Sales unit	Order no.
 Plexiglas, polycarbonate 2-20 mm, non-ferrous metals 2-10 mm Clearance angle offset, tooth ground	HSS	74	1,25	2,0 mm/12 TPI	T 101 A	5	623640000*



"Expert plastics premium" jigsaw blades

- For special applications: plastics
- Very long service life thanks to welded-on carbide teeth

Version	Material	Useable length mm	Thickness mm	Tooth pitch	Corresponds to Bosch type	Sales unit	Order no.
 Fibreglass reinforced plastics, Corian 4-60 mm Ground	HM	91	1,25	3,3 mm/7 TPI	T 301 CHM	3	623687000*



"Expert ceramics" jigsaw blades

- For special applications; ceramic materials, for example soft tiles
- Carbide coated for very long service life

Version	Material	Useable length mm	Thickness mm	Tooth pitch	Corresponds to Bosch type	Sales unit	Order no.
 Ceramic, glass, fibre glass reinforced plastics, cast iron Coarse	Carbide, coated	76	0,8	Grain size 30	T 130 Riff	1	623657000*
 Ceramic, glass, fibre glass reinforced plastics, cast iron Fine	Carbide, coated	76	0,8	Grain size 50	T 150 Riff	1	623658000*

"Expert fibre + plaster" jigsaw blades

- For special applications: gypsum plaster, cement materials
- Welded-on carbide teeth for excellent service life

Version	Material	Useable length mm	Thickness mm	Tooth pitch	Corresponds to Bosch type	Sales unit	Order no.
 Gypsum plaster, cement fibre board 5-50 mm, fibreglass reinforced plastics 5-20 mm Ground	HM	74	1,25	4,3 mm/6 TPI	T 141 HM	1	623652000*
 Gypsum plaster, cement fibre board 5-80 mm, fibreglass reinforced plastics 5-50 mm Ground	HM	106	1,25	4,3 mm/6 TPI	T 341 HM	1	623688000*
						3	623671000*

"Expert Inox" jigsaw blades



- For special applications: stainless steel, Inox

Version	Material	Useable length mm	Thickness mm	Tooth pitch	Corresponds to Bosch type	Sales unit	Order no.
 Stainless steel sheets (Inox) 1-2 mm, non-ferrous metals Ground	HM	57	1	1,1 mm/23 TPI	T 118 AHM	3	623662000*
 Stainless steel sheets (Inox) 2-4 mm, non-ferrous metals Ground	HM	57	1	1,4 mm/18 TPI	T 118 EHM	3	623663000*

*Self-service packaging

"Expert aluminium" jigsaw blades

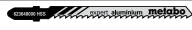
- For special applications: aluminium and NF metals





Version	Material	Useable length mm	Thickness mm	Tooth pitch	Corresponds to Bosch type	Sales unit	Order no.
 Aluminium 3-15 mm, non-ferrous metals 4-20 mm, plastics, for quick cuts							
Milled, offset	HSS	74	1	3,0 mm/8 TPI	T 127 D	5	623639000*
						25	623622000*
 Aluminium 3-15 mm, non-ferrous metals 4-20 mm, especially for curved cuts							
Milled, offset	HSS	74	1	3,0 mm/8 TPI	T 227 D	5	623648000*
 Aluminium 3-15 mm, non-ferrous metals 4-20 mm, plastics, for quick cuts, long service life							
Milled, offset	BiM	75	1	3,0 mm/8 TPI	T 127 DF	5	623974000*

"Expert soft materials" jigsaw blades

- For special applications: e.g. soft materials, carton
- Clean cuts with little effort thanks to blade edge

Version	Material	Useable length mm	Thickness mm	Tooth pitch	Corresponds to Bosch type	Sales unit	Order no.
 Polystyrene, cardboard, leather, rubber, carpet up to 50 mm							
Blades ground, straight	HCS	74	1,25	Blade edge	T 113 A	5	623641000*
 Polystyrene, cardboard, leather, rubber, carpet up to 50 mm							
Blades ground, wavy	HCS	126	1	Blade edge	T 313 AW	3	623684000*

Jigsaw blade assortments with single-lug shank

	Order no.
 <p>Jigsaw blade assortment 1</p> <ul style="list-style-type: none"> For wood and metal HCS saw blades/HSS saw blade <p>Consisting of 1 saw blade each: 623634000, 623633000, 623637000 Suitable material: wood, metal Number of parts: 3</p>	623968000*
 <p>Jigsaw blade assortment 2</p> <ul style="list-style-type: none"> For wood, metal and plastic HCS saw blades/HSS saw blade <p>Consisting of 1 saw blade each: 623633000, 623635000, 623632000, 623631000 and 623637000 Suitable material: wood, plastic, metal Number of parts: 5</p>	623645000*
 <p>Jigsaw blade assortment 3</p> <ul style="list-style-type: none"> For wood, metal and plastic HCS saw blades/HSS saw blades <p>Consisting of 2 jigsaw blades each 623634000, 623633000, 623646000, 623637000, 623638000 Material suitability: Wood, metal, plastics Number of parts: 10</p>	623600000*
 <p>Jigsaw blade assortment 4</p> <ul style="list-style-type: none"> For wood HCS saw blades <p>Consisting of 10 saw blades 623633000 and 623635000 and 5 saw blade 623649000 Suitable material: wood Number of parts: 25</p>	623698000*

Jigsaw blades with universal shank

"Basic wood" / U jigsaw blades

- Good cutting results with good tool life

Version	Material	Useable length mm	Thickness mm	Tooth pitch	Corresponds to Bosch type	Sales unit	Order no.
 Hard wood, soft wood, chipboards, wood-core plywood, fibre boards 5-50 mm, for clean cuts							
Milled, offset	HCS	74	1,25	3,0 mm/8 TPI	U 111 C	5	623945000*

"Fast wood" / U jigsaw blades

- Fast and straight cuts

Version	Material	Useable length mm	Thickness mm	Tooth pitch	Corresponds to Bosch type	Sales unit	Order no.
 Hard wood, soft wood, chipboards, wood-core plywood, fibre boards 5-50 mm							
Ground, offset	HCS	82	1,25	4,0 mm/6 TPI	U 144 D	5	623944000*

"Clean wood" / U jigsaw blades

- Fast, clean and angle-precise

Version	Material	Useable length mm	Thickness mm	Tooth pitch	Corresponds to Bosch type	Sales unit	Order no.
 Hard wood, soft wood, chipboards, wood-core plywood, fibre boards 10-45 mm, for clean cuts							
Clearance angle offset, tooth ground	HCS	82	1,25	2,5 mm/10 TPI	U 101 B	5	623943000*

Jigsaw blades "clean wood premium" / U

- Clean and precise cuts with a very long service life

Version	Material	Useable length mm	Thickness mm	Tooth pitch	Corresponds to Bosch type	Sales unit	Order no.
 Hard wood, soft wood, chipboards, wood-core plywood, fibre boards 3-30 mm, coated boards, for clean cuts							
Clearance angle offset, tooth ground	BiM	82	1,25	2,5 mm/10 TPI	U 101 BF	5	623905000*

"Universal wood + metal" / U jigsaw blades

- Fast and clean into all wood strengths with metal elements

Version	Material	Useable length mm	Thickness mm	Tooth pitch	Corresponds to Bosch type	Sales unit	Order no.
 Wood, wood with nails, metal, non-ferrous metals, plastics							
Milled, offset	BiM	107	1,25	2,4-5,0 mm/10-5 TPI Progressive	U 345 XF	5	623906000*

*Self-service packaging



01
02
03
04
05
06
07
08
09
10
11
12
13
14
15
16

"Basic metal" / U jigsaw blades











- Good cutting results with good tool life

Version	Material	Useable length mm	Thickness mm	Tooth pitch	Corresponds to Bosch type	Sales unit	Order no.
 Steel sheets 1-3 mm							
Milled, wavy	HSS	52	0,8	1,2 mm/21 TPI	U 118 A	5	623941000*
 Steel sheets, 2.5-6 mm,							
Milled, wavy	HSS	52	1	2,0 mm/12 TPI	U 118 B	5	623940000*

Other accessories for jigsaws

	Order no.
 <p>Plastic guard plate</p> <ul style="list-style-type: none"> ■ For fitting on the base plate of the jigsaw ■ The plastic universal guard plate for protecting all work piece surfaces ■ Guide rail adapter can be coupled on both sides, compatible with Metabo, Mafell and Bosch ■ Rubberised immersion aid for plunge cuts ■ Chip guard plates can be used <p>Suitable for machine: STE 140, STE 140 Plus, STEB 140, STEB 140 Plus, STA 18 LTX 140</p>	623595000*
 <p>Plastic guard plate with felt</p> <ul style="list-style-type: none"> ■ For fitting on the base plate of the jigsaw ■ The plastic felt guard plate prevents extremely sensitive work piece surfaces from scratches, incl. 3 replacement felts ■ Guide rail adapter can be coupled on both sides, compatible with Metabo, Mafell and Bosch ■ Rubberised immersion aid for plunge cuts ■ Chip guard plates can be used <p>Suitable for machine: STE 140, STE 140 Plus, STEB 140, STEB 140 Plus, STA 18 LTX 140</p>	623596000*
 <p>Plastic guard plate with fabric reinforced laminate insert</p> <ul style="list-style-type: none"> ■ For fitting on the base plate of the jigsaw ■ The durable plastic fabric reinforced laminate guard plate for highest sliding quality on wood or wood-like material surfaces ■ Guide rail adapter can be coupled on both sides, compatible with Metabo, Mafell and Bosch ■ Rubberised immersion aid for plunge cuts ■ Chip guard plates can be used <p>Suitable for machine: STE 140, STE 140 Plus, STEB 140, STEB 140 Plus, STA 18 LTX 140</p>	623597000*
 <p>Guard Plate</p> <ul style="list-style-type: none"> ■ For fitting on the base plate of the jigsaw ■ The guard plate protects sensitive work piece surfaces from scratches <p>Suitable for machine: STEB 70 Quick, STEB 80 Quick, STE 90 SCS, STE 100 SCS, STA 18 LTX, STE 100 Plus, STE 135, STE 135 Plus, STEB 135, STEB 135 Plus, STEB 65 Quick, STE 100 Quick, STA 18 LTX 100, STAB 18 LTX 100</p>	623664000*
 <p>Circle-cutting and parallel guide</p> <ul style="list-style-type: none"> ■ For cutting circles of Ø 100 to Ø 360 mm and for cutting parallel to an edge (maximum distance from the edge 210 mm). <p>Suitable for machine: STE 140, STE 140 Plus, STEB 140, STEB 140 Plus, STA 18 LTX 140, STEB 65 Quick, STE 100 Quick, STA 18 LTX 100, STAB 18 LTX 100</p>	623591000*
 <p>Circle-cutting and parallel guide</p> <ul style="list-style-type: none"> ■ For cutting circles of Ø 100 to Ø 360 mm and for cutting parallel to an edge (maximum distance from the edge 210 mm). <p>Suitable for machine: STE 100 Plus, STE 135, STE 135 Plus, STEB 135, STEB 135 Plus, STA 18 LTX, STEB 70 Quick, STEB 80 Quick, STE 90 SCS, STE 100 SCS</p>	631340000*

*Self-service packaging

	Order no.
 <p>Guide rail 31213</p> <ul style="list-style-type: none"> ■ Guide rail made of sturdy, anodised aluminium extrusion ■ Anti-slip backing provides safe and reliable support and protects the work piece surface against scratches ■ Guide rule, adjustable to eliminate play <p>suitable for: Metabo jigsaws, circular saws and router models OFE 738 and Of E 1229 Signal (when using the appropriate accessories; KS 55 FS, KSE 55 Vario Plus, KS 66 Plus, KSE 68 Plus can be used directly); also suitable for the CED 125 Plus dust extraction shroud in connection with an angle grinder Overall length: 1,500 mm</p>	631213000
 <p>Connector</p> <ul style="list-style-type: none"> ■ For the trouble-free joining together of two precision guide rails ■ Can only be used with guide rail 631213000 	631211000
 <p>2 Tensioning clamps FSZ</p> <ul style="list-style-type: none"> ■ For the attachment of the guide rails on the workpiece or the workbench 	631031000
 <p>Guiding device</p> <ul style="list-style-type: none"> ■ For using jigsaws in conjunction with the precision guide rail <p>Suitable for machine: STEB 70 Quick, STEB 80 Quick, STE 90 SCS, STE 100 SCS, STE 100 Plus, STE 135, STE 135 Plus, STEB 135, STEB 135 Plus, STA 18 LTX</p>	631249000
 <p>Lubricating / cooling stick</p> <ul style="list-style-type: none"> ■ Increase of durability with tools, for example, core drills, metal drill bits, BiM hole saws, router bits or saw blades 	623443000
 <p>3 Chip guard plates</p> <ul style="list-style-type: none"> ■ For splinter-free sawing with the jigsaw <p>Suitable for machine: STE 100 Plus, STE 135, STE 135 Plus, STEB 135, STEB 135 Plus</p>	623665000*
 <p>3 Chip guard plates</p> <ul style="list-style-type: none"> ■ For splinter-free sawing with the jigsaw <p>Suitable for machine: STEB 70 Quick, STEB 80 Quick, STE 90 SCS, STE 100 SCS, STA 18 LTX, ST 50 Pendix, STE 70, STE 80 Quick, STE 140, STE 140 Plus, STEB 140, STEB 140 Plus, STA 18 LTX 140, STEB 65 Quick, STE 100 Quick, STA 18 LTX 100, STAB 18 LTX 100</p>	631208000*
 <p>Extraction set</p> <ul style="list-style-type: none"> ■ Extraction set with corrugated end for safe connection to the Metabo all-purpose vacuum cleaner with suction hose Ø 27 mm and 35 mm. <p>Suitable for machine: STA 18 LTX 140</p>	623669000*
 <p>Extraction set</p> <ul style="list-style-type: none"> ■ Extraction set with corrugated end for safe connection to the Metabo all-purpose vacuum cleaner with suction hose Ø 27 mm and 35 mm <p>Suitable for machine: STE 140, STE 140 Plus, STEB 140, STEB 140 Plus</p>	623670000*
 <p>Suction hose Ø 27 mm</p> <ul style="list-style-type: none"> ■ Flexible and easy extension: extraction hose can be connected to a second one without additional connector ■ Rubber connector (internal Ø 30 mm, outside Ø 35 mm) <p>Hose length: 3.5 m Hose-Ø, internal: 27 mm Hose-Ø, external: 33 mm Connection-Ø, external: 27 mm</p> <p>Anti-static: no Conducts electricity: no Bayonet connection: yes Rotation compensation: machine side</p>	631938000
 <p>Suction hose Ø 27 mm</p> <ul style="list-style-type: none"> ■ Flexible and easy extension: extraction hose can be connected to a second one without additional connector ■ Rubber connector (internal Ø 30 mm, outside Ø 35 mm) <p>Hose length: 3.5 m Hose-Ø, internal: 27 mm Hose-Ø, external: 33 mm Connection-Ø, external: 27 mm</p> <p>Anti-static: yes Conducts electricity: no Bayonet connection: yes</p>	631939000

Metal

Order no. (corresponds to Bosch type)	Material	Material to be processed	Sheet metal	Pipes, profiles	Demolition and reconstruction work		
631129000 (S 918 AF)	BIM	For flush cuts	< 3,0 mm	< 100 mm	-		
631130000 (S 918 BF)			< 8,0 mm	< 175 mm	-		
631454000 (S 922 EF)			> 8,0 mm	< 250 mm	-		
631493000 (S 1122 EF)			For flush cuts	< 3,0 mm	< 100 mm	-	
631491000 (S 922 BF)				< 8,0 mm	< 175 mm	-	
631494000 (S 1122 BF)			For flush cuts	> 8,0 mm	< 250 mm	-	
628267000 (S 522 BF)				Short	-	-	
628268000 (S 522 EF)			Short	-	-	-	
626566000			BIM	Clean straight, precise	< 3,0 mm	< 100 mm	-
626567000					< 8,0 mm	< 175 mm	-
626568000	> 8,0 mm	< 250 mm			-		
626569000	Short	-			-		
628260000 (S 925 VF)	BIM	Extra long	< 3,0 mm	< 100 mm	-		
631991000 (S 1025 VF)			< 8,0 mm	< 175 mm	-		
628261000 (S 1125 VF)			> 8,0 mm	< 250 mm	-		
628263000 (S 1125 VF)			Clean straight, precise	< 3,0 mm	< 100 mm	-	
631909000 (S 1025 BF)				< 8,0 mm	< 175 mm	-	
628255000 (S 926 BEF)			Clean straight, precise	> 8,0 mm	< 250 mm	-	
628256000 (S 1126 BEF)				Short	-	-	
628257000 (S 926 CHF)			Short	-	-	-	
631989000 (T 1126 CHF)			Short	-	-	-	
631992000 (S 920 CF)			BIM	Extra thick, robust	< 3,0 mm	< 100 mm	-
631993000 (S 1120 CF)	< 8,0 mm	< 175 mm			-		
628258000 (S 1136 BEF)	BIM	Clean, straight, precise, high durability	< 3,0 mm	< 100 mm	-		
628269000 (S 1136 CHF)			< 8,0 mm	< 175 mm	-		
631914000 (S 123 XF)	BIM	Universal	< 3,0 mm	< 100 mm	-		
626556000 (S 522 EF)	HM	Straight, precise	< 8,0 mm	< 175 mm	-		
626557000 (S 1155 CHM)			> 8,0 mm	< 250 mm	-		

Wood

Order no. (corresponds to Bosch type)	Material	Material to be processed	Wood (dry), chipboard, plywood	Wood (damp), firewood, removal of branches	Plastics
628241000 (S 617 K)	HCS	For curved cuts, fast, coarse	< 100 mm	< 100 mm	< 100 mm
628242000 (S 1617 K)			< 190 mm	< 190 mm	< 190 mm
628244000 (S 1111 K)	HCS	Extra long, fast, coarse	< 250 mm	< 250 mm	< 250 mm
631470000 (S 644 D)			< 100 mm	< 100 mm	< 100 mm
631472000 (S 1344 D)	HCS	Fast, coarse	< 190 mm	< 190 mm	< 190 mm
631488000 (S 1531 L)			< 250 mm	< 250 mm	< 250 mm
631913000 (S 2345 X)	HCS	Universally progressively toothed	< 100 mm	< 100 mm	< 100 mm

Wood + Metal

Order no. (corresponds to Bosch type)	Material	Material to be processed	Wood, chipboards	Wood with nails/metal insert	Sheet metal	Pipes/profiles	Plastics/window frames	Pallet repairs	Demolition and reconstruction work		
631125000 (S 1211 H)	BIM (631125000 HCS)	Extra long	< 100 mm	< 100 mm	< 3,0 mm	< 100 mm	< 100 mm	-	-		
631492000 (S 922 VF)			< 175 mm	< 175 mm	< 8,0 mm	< 175 mm	< 175 mm	-	-		
631495000 (S 1122 VF)			< 250 mm	< 250 mm	> 8,0 mm	< 250 mm	< 250 mm	-	-		
631407000 (S 1222 VF)			Extra long	< 100 mm	< 100 mm	< 3,0 mm	< 100 mm	< 100 mm	-	-	
631932000 (S 1022 HF)				< 175 mm	< 175 mm	< 8,0 mm	< 175 mm	< 175 mm	-	-	
628265000 (S 511 DF)			Short	Especially for pallet repairs	< 100 mm	< 100 mm	< 3,0 mm	< 100 mm	< 100 mm	-	-
628266000 (S 522 BEF)				Short	< 175 mm	< 175 mm	< 8,0 mm	< 175 mm	< 175 mm	-	-
631925000 (S 610 DF)			BiM	Extra thick, robust, short	< 250 mm	< 250 mm	> 8,0 mm	< 250 mm	< 250 mm	-	-
631926000 (S 1156 XHM)					Extra thick, robust, long	< 100 mm	< 100 mm	< 100 mm	< 100 mm	< 100 mm	-
631984000 (S 611 VF)			BiM	Extra long	< 100 mm	< 100 mm	< 3,0 mm	< 100 mm	< 100 mm	-	-
631986000 (S 1111 VF)	< 175 mm	< 175 mm			< 8,0 mm	< 175 mm	< 175 mm	-	-		
631987000 (S 1411 VF)	< 250 mm	< 250 mm			> 8,0 mm	< 250 mm	< 250 mm	-	-		
631915000 (S 3456 XF)	BiM	Universally progressively toothed	< 100 mm	< 100 mm	< 3,0 mm	< 100 mm	< 100 mm	-	-		
626559000 (S 956 XHM)	HM	Clean straight, precise	< 175 mm	< 175 mm	< 8,0 mm	< 175 mm	< 175 mm	-	-		
626560000 (S 1156 XHM)			< 250 mm	< 250 mm	> 8,0 mm	< 250 mm	< 250 mm	-	-		

Special applications

Order no. (corresponds to Bosch type)	Material	Material to be processed	Stainless steel sheet (Inox)	Plastics, glass-fibre reinforced plastics	Cardboard, polystyrene, insulation materials	Gypsum plaster	Cast-iron pipes	Brickwork	Aerated concrete blocks, fibre-reinforced cement	Masonry, brickwork, porous concrete, sand-lime brick, cement board
631817000 (S 518 EHM)	HM		2-4 mm	-	-	-	< Ø 6"	< 100 mm	< 100 mm	< 150 mm
631818000 (S 1130 Riff)	HM Coated		-	-	-	-	< 6"	< 250 mm	< 250 mm	< 215 mm
626565000 (S 1050 RD)	RD Coated	Long service life	-	-	-	-	< 6"	< 350 mm	< 350 mm	< 365 mm
631137000 (S 641 HM)	HM	Short	-	-	-	-	< 6"	< 100 mm	< 100 mm	< 150 mm
631146000 (S 1241 HM)			Long	-	-	-	-	< 250 mm	< 250 mm	< 215 mm
631819000 (S 2041 HM)	HM	Extra long	-	-	-	-	< 6"	< 350 mm	< 350 mm	< 365 mm
631916000 (S 1543 HM)			-	-	-	-	-	< 100 mm	< 100 mm	< 150 mm
631917000 (S 1234 HM)	HM	Clean cuts, short version	-	-	-	-	< 6"	< 250 mm	< 250 mm	< 215 mm
631918000 (S 2243 HM)			Clean cuts	-	-	-	-	< 350 mm	< 350 mm	< 365 mm
628264000 (S 528 DF)	BiM	Clean cuts	-	-	-	-	< 6"	< 100 mm	< 100 mm	< 150 mm
631907000 (S 628 DF)			-	-	-	-	-	< 250 mm	< 250 mm	< 215 mm
626563000 (S 1213 AMP)	HCS	»expert fibre insulation«	-	-	-	-	< 6"	< 100 mm	< 100 mm	< 150 mm
631144000 (S 713 AW)	HCS	»expert soft materials«	-	-	-	-	< 6"	< 100 mm	< 100 mm	< 150 mm

Legend

*progressively toothed = Tooth pitch ascending suitable for both thin and thick materials
 ■ Highly suitable □ Only suitable under certain circumstances

- Extensive range of sabre saw blades
- The right saw blade for all applications
- Concise subcategories: find the right saw blade fast
- Clear structure thanks to colour coding system

Features of the Metabo sabre saw blades

Colour coding system

The colour indicates for which material the saw blade is best suited.

metal	Metal
wood + metal	Wood with nails/metal elements
wood	Wood
carbide	"Carbide": innovative carbide technology for excellent service life for demanding demolishing work in wood with nails/metal elements and straight cuts into metal e.g. high-strength steel, cast steel/grey cast
expert	Special applications in the field of building trade and renovation
expert carbide	Special applications in the field of building trade and renovation Very long service life thanks to carbide strip, welded-on carbide teeth or carbide mounting

Application lines

metal	wood & metal	wood	building materials/ expert for
»flexible metal«	»flexible wood+metal«	»fast wood«	»expert inox«*
»flexible fast metal«	»demolition wood+metal«	»precision wood«	»expert cast iron«*
»demolition metal«	»heavy wood+metal«	»universal wood«	»expert cast iron premium«**
»heavy metal«	»universal wood+metal«		»expert fiber plaster«*
»heavy metal premium«	»carbide wood+metal«		»expert brick«*
»universal metal«			»expert plaster«
»carbide metal«			»expert fibre insulation«
			»expert soft materials«

*carbide **RD

Steel blade material/saw blade teeth

HCS	Carbon steel, for cutting soft wood, hardboards, plastics
HSS	High yielding high-speed steel, suitable for metal, aluminium work
BiM	Bi-metal: particularly flexible mix of HCS and HSS. The saw blades have a much higher life expectancy than HCS and HSS and have proven their worth when there is risk of the shaft breaking
HM/CT	Carbide: innovative carbide technology for excellent service life Carbide strip or carbide mounting for a very long service life
RD	Diamond coating for a very long service life for special applications, e.g. cuts in cast pipes (also with cement lining), glassfibre-reinforced plastics, Epoxy and very abrasive materials

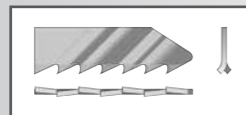

Teeth milled, offset for clearance gap
A relatively rough cut, fast progress in cutting on hard and soft wood, aluminium, non-ferrous metals and plastics



Teeth milled, waved for clearance gap
A fine cut with straight tool guidance in hard and soft wood, aluminium, non-ferrous metals and plastics

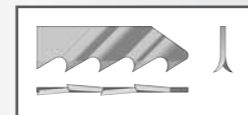

Teeth ground, offset for clearance gap
Fast cutting in hard and soft wood

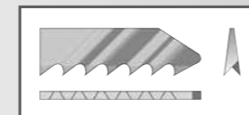

Teeth ground, offset for clearance angle and clearance gap
Fine and clean cut in wood and plastics

Shaft form

The sabre saw blades from Metabo are produced with a universal shank shape matching the sabre saws of standard brand names.



Sabre saw blades with 1/2" universal shank

"Flexible metal" sabre saw blades





- Unbreakable, flexible, sabre saw blades <1.0 mm thick

Version	Material finish	Overall length mm	Thickness mm	Tooth pitch	Corresponds to Bosch type	Sales unit	Order no.
Flexible metal							
Sheets 1-3 mm, profiles 5-100 mm							
Wavy, milled	BiM	150	0,9	1 mm/ 24 TPI	S 918 AF	2	631129000*
Flexible metal							
Sheets 2-8 mm, profiles 10-100 mm							
Wavy, milled	BiM	150	0,9	1,8 mm/ 14 TPI	S 918 BF	2	631130000*
Flexible metal							
Sheets 0.7-3 mm, profiles Ø 0.5-100 mm, profiles 0.5-100 mm							
Offset, milled	BiM	150	0,9	1,4 mm/ 18 TPI	S 922 EF	2	631080000*
						5	631454000*
						25	628251000*
Flexible metal							
Sheets 1.5-4 mm, profiles Ø 5-175 mm, profiles 5-175 mm for flush cuts							
Offset, milled	BiM	225	0,9	1,4 mm/ 18 TPI	S 1122 EF	2	631095000*
						5	631493000*
						25	628252000*
Flexible metal							
Sheets 3-8 mm, pipes, profiles Ø 10-100 mm							
Offset, milled	BiM	150	0,9	1,8 mm/ 14 TPI	S 922 BF	2	631093000*
						5	631491000*
						25	628253000*
						100	625491000
Flexible metal							
Sheets 3-8 mm, pipes, profiles Ø 10-175 mm, flush cuts							
Offset, milled	BiM	225	0,9	1,8 mm/ 14 TPI	S 1122 BF	2	631096000*
						5	631494000*
						25	628254000*
						100	625492000
Flexible metal							
Sheets 3-8 mm, profiles							
Offset, milled	BiM	100	0,9	2 mm/ 14 TPI	S 522 BF	5	628267000*
Flexible metal							
Sheets 0.7-3 mm, profiles							
Offset, milled	BiM	100	0,9	1,4 mm/ 18 TPI	S 522 EF	5	628268000*

*Self-service packaging



"Flexible fast metal" sabre saw blades

- Curved blade shape perfectly supports the orbital movement of the sabre saw and ensures best possible power transmission
- 30% higher cutting speed compared to straight saw blades
- More cuts - less frequent blade change: up to 25% longer service life of the saw blade

Version	Material finish	Overall length mm	Thickness mm	Tooth pitch	Corresponds to Bosch type	Sales unit	Order no.
 Sheet metal 1.5-4 mm, profiles Ø 0.5-100 mm, pipes. for fast cuts, metal	BiM	150	0,9	1,4 mm/18 TPI	-	5 NEW	626566000*
 Sheet metal 1.5-4 mm, profiles Ø 0.5-100 mm, pipes. for fast cuts, metal	BiM	225	0,9	1,4 mm/18 TPI	-	5 NEW	626567000*
 Sheet metal 3-8 mm, profiles Ø 0.5-100 mm, pipes. for fast cuts, metal	BiM	150	0,9	1,8 mm/14 TPI	-	5 NEW	626568000*
 Sheet metal 3-8 mm, profiles Ø 0.5-100 mm, pipes. for fast cuts, metal	BiM	225	0,9	1,8 mm/14 TPI	-	5 NEW	626569000*





"Demolition metal" sabre saw blades



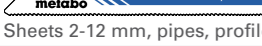

- Especially for metal removal work
- High stability and robustness thanks to extra thick saw blade thickness (1.6 mm)

Version	Material finish	Overall length mm	Thickness mm	Tooth pitch	Corresponds to Bosch type	Sales unit	Order no.
 Sheets 4-10 mm, pipes, profiles Ø 20-100 mm, for pipe cutting equipment, for breaking and renovation work, glass	BiM	150	1,6	2,5+3,2 mm/ 8+10 TPI	S 920 CF	5	631992000*
 Sheets 4-10 mm, pipes, profiles Ø 20-175 mm, for pipe cutting equipment, for breaking and renovation work, glass	BiM	225	1,6	2,5+3,2 mm / 8+10 TPI	S 1120 CF	5	631993000*

"Heavy metal" sabre saw blades

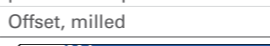

- Stable, precise, for tough applications, sabre saw blades >1.0 mm thick

Version	Material finish	Overall length mm	Thickness mm	Tooth pitch	Corresponds to Bosch type	Sales unit	Order no.
 Sheets 2-12 mm, pipes, profiles Ø 10-100 mm	BiM	150	1,25	1,8/2,6 mm/10/14 TPI	S 925 VF	5	628260000*
 Sheets 2-12 mm, pipes, profiles Ø 10-150 mm	BiM	200	1,25	1,8/2,6 mm/10/14 TPI	S 1025 VF	5	631991000*
 Sheets 2-12 mm, pipes, profiles Ø 10-175 mm	BiM	225	1,25	1,8/2,6 mm/10/14 TPI	S 1125 VF	5	628261000*
 Sheets 2-12 mm, pipes, profiles Ø 10-250 mm	BiM	300	1,25	1,8/2,6 mm/10/14 TPI	S 1225 VF	5	628263000*

Version	Material finish	Overall length mm	Thickness mm	Tooth pitch	Corresponds to Bosch type	Sales unit	Order no.
 Sheets 2-8 mm, pipes, profiles Ø 10-150 mm	BiM	200	1,25	1,8 mm/ 14 TPI	S 1025 BF	5	631909000*
 Sheets 3-8 mm, pipes, profiles Ø 20-100 mm, for pipe cutting equipment, for breaking and renovation work for straight, precise and particularly clean cuts	BiM	150	1,1	1,4+ 1,8 mm/14+18 TPI	S 926 BEF	5	628255000*
 Sheets 3-8 mm, pipes, profiles Ø 20-175 mm, for pipe cutting equipment, for breaking and renovation work for straight, precise and particularly clean cuts	BiM	225	1,1	1,4+1,8 mm/ 14+18 TPI	S 1126 BEF	5	628256000*
 Sheets 4-10 mm, pipes, profiles Ø 20-100 mm, for pipe cutting equipment, for breaking and renovation work for straight, precise and quick cuts	BiM	150	1,1	2,5+3,2 mm/ 8+10 TPI	S 926 CHF	5	628257000*
 Sheets 4-10 mm, pipes, profiles Ø 20-175 mm, for pipe cutting equipment, for breaking and renovation work for straight, precise and quick cuts	BiM	225	1,1	2,5+ 3,2 mm/ 8+10 TPI	S 1126 CHF	5	631989000*

"Heavy metal premium" sabre saw blades

- Higher cutting speed and longest tool life thanks to unique, as well as very aggressive and robust serration

Version	Material finish	Overall length mm	Thickness mm	Tooth pitch	Corresponds to Bosch type	Sales unit	Order no.
 Sheets 3-8 mm, pipes, profiles Ø 20-175 mm, for pipe cutting equipment, for straight, precise and particularly clean cuts with an extremely long service life	BiM	225	0,9	1,4+1,8 mm / 14+18 TPI	S 1136 BEF	2	628258000*
 Sheets 4-10 mm, pipes, profiles Ø 20-175 mm, for pipe cutting equipment, for straight, precise and quick cuts with an extremely long service life	BiM	225	1,1	2,5+3,2 mm / 8+10 TPI	S 1136 CHF	2	628269000*

"Universal metal" sabre saw blades

- Universal and quick in both thick and thin material

Version	Material finish	Overall length mm	Thickness mm	Tooth pitch	Corresponds to Bosch type	Sales unit	Order no.
 Sheets 1-8 mm, profiles Ø 5-100 mm	BiM	150	0,9	1,8-3,2 mm/8-14 TPI/ Progressive	S 123 XF	2	631911000*
						5	631914000*

*Self-service packaging

"Carbide metal" sabre saw blades

- Individually welded-on carbide teeth for excellent service life
- For accurate and straight cuts in metal, e.g. high-tensile steel, cast steel/grey cast
- 20x longer service life compared to bi-metal saw blades

Version	Material finish	Overall length mm	Thickness mm	Tooth pitch	Corresponds to Bosch type	Sales unit	Order no.
 Carbide-tipped	HM	150	1,25	3 mm/8 TPI	S 955 CHM	1 NEW	626556000*
 Carbide-tipped	HM	225	1,25	3 mm/8 TPI	S 1155 CHM	1 NEW	626557000*



"Flexible wood + metal" sabre saw blades

- Unbreakable, flexible, sabre saw blades <1.0 mm thick

Version	Material finish	Overall length mm	Thickness mm	Tooth pitch	Corresponds to Bosch type	Sales unit	Order no.
 Wood, wood with nails, non-ferrous metals, plastics Offset, milled	HCS	300	0,9	2,5 mm/ 10 TPI	S 1211 H	2	631125000*
 Wood, wood with nails, metal inserts Ø 5-100 mm, sheets, pipes, profiles 3-10 mm, plastics 3-100 mm Offset, milled	BiM	150	0,9	1,8-2,6 mm/ 10-14 TPI	S 922 VF	2 5 25	631094000* 631492000* 628246000*
 Wood, wood with nails, metal inserts Ø 5-175 mm, sheets, pipes, profiles 3-10 mm, plastics 3-175 mm Offset, milled	BiM	225	0,9	1,8-2,6 mm/ 10-14 TPI	S 1122 VF	2 5 25 100	631097000* 631495000* 628247000* 625494000
 Wood, wood with nails, metal inserts Ø 5-250 mm, sheets, pipes, profiles 3-10 mm, plastics 3-250 mm Offset, milled	BiM	300	0,9	1,8-2,6 mm/ 10-14 TPI	S 1222 VF	2 5 25	631098000* 631407000* 628248000*
 Wood, wood with nails, metal inserts Ø 5-150 mm, pallets, sheets, pipes, profiles 3-12 mm, plastics 3-150 mm Offset, milled	BiM	200	0,9	2,5 mm/ 10 TPI	S 1022 HF	5 200	631932000* 625497000
 Wood, wood with nails, wood, plastics, plywood Offset, milled	BiM	100	0,9	4,0 mm/6 TPI	S 511 DF	5	628265000*
 wood, metal, plastics Offset, milled	BiM	100	0,9	1,4 /1,8 mm/14/18 TPI	S 522 BEF	5	628266000*



"Demolition wood + metal" sabre saw blades

- Especially for demolition work in wood with steel elements or nails
- High stability and robustness thanks to extra thick saw blade thickness (1.6 mm)

Version	Material finish	Overall length mm	Thickness mm	Tooth pitch	Corresponds to Bosch type	Sales unit	Order no.
 Wood, wood with nails, metal inserts Ø 10-100 mm, plastics, for breaking and renovation work Offset, milled	BiM	150	1,6	4,3 mm/ 6 TPI	S 610 DF	5	631925000*
 Wood, wood with nails, metal inserts Ø 10-175 mm, plastics, for breaking and renovation work Offset, milled	BiM	225	1,6	4,3 mm/ 6 TPI	S 1110 DF	5	631926000*

"Heavy wood + metal" sabre saw blades

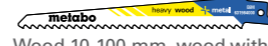
- Fast, stable, for tough applications, sabre saw blades >1.0 mm thick

Version	Material finish	Overall length mm	Thickness mm	Tooth pitch	Corresponds to Bosch type	Sales unit	Order no.
 Wood 10-100 mm, wood with nails, plastics, window frames, specially designed for plunge cuts Offset, milled	BiM	150	1,25	3,2/5,1 mm/5/8 TPI	S 611VF	5 25 100	631984000* 628250000* 628259000*
 Wood, wood with nails, plastics, plywood 10-175 mm Offset, milled	BiM	225	1,25	3,2/5,1 mm/5/8 TPI	S 1111 VF	5	631986000*
 Wood, wood with nails, plastics, plywood 10-250 mm Offset, milled	BiM	300	1,25	3,2/5,1 mm/5/8 TPI	S 1411 VF	5	631987000*



"Universal wood + metal" sabre saw blades

- Universal and quick in all materials

Version	Material finish	Overall length mm	Thickness mm	Tooth pitch	Corresponds to Bosch type	Sales unit	Order no.
 Wood, wood with nails, metal inserts Ø 5-150 mm, sheets, pipes, profiles 3-18 mm, plastics 5-150 mm Offset, milled	BiM	200	1,25	2,1-4,3 mm/6-12 TPI/ Progressive	S 3456 XF	2 5	631912000* 631915000*

"Carbide wood + metal" sabre saw blades



- Individually welded-on carbide teeth for excellent service life
- Ideal for very demanding demolition work e.g. wood with nails or metal elements
- 20x longer service life compared to bi-metal saw blades

Version	Material finish	Overall length mm	Thickness mm	Tooth pitch	Corresponds to Bosch type	Sales unit	Order no.
 Carbide-tipped	HM	150	1,25	3-4 mm/6-8 TPI	S 956 XHM	1 NEW	626559000*
 Carbide-tipped	HM	225	1,25	3-4 mm/6-8 TPI	S 1156 XHM	1 NEW	626560000*

*Self-service packaging

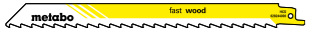

"Fast wood" sabre saw blades

- For tough applications on the construction site and in the garden

Version	Material finish	Overall length mm	Thickness mm	Tooth pitch	Corresponds to Bosch type	Sales unit	Order no.
 Wood (also when damp) 6-100 mm, removal of branches, for fast, rough cuts, specially designed for curved cuts							
Offset, milled	HCS	150	1,25	8,5 mm/ 3 TPI	S 617 K	5	628241000*
 Wood (also when damp) 10-250 mm, removal of branches, for fast, rough cuts							
Offset, milled	HCS	300	1,25	8,5 mm/ 3 TPI	S 1617 K	5	628242000*
 Wood (also when damp) 15-190 mm, firewood, for fast, rough cuts							
Offset, milled	HCS	225	1,25	8,5 mm/ 3 TPI	S 1111 K	5	628244000*

"Precision wood" sabre saw blades

- For professional applications on the construction site and in the garden

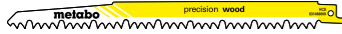
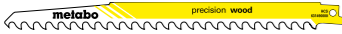
Version	Material finish	Overall length mm	Thickness mm	Tooth pitch	Corresponds to Bosch type	Sales unit	Order no.
 Wood 6-100 mm, chipboard 6-60 mm, plywood, plastics, specially designed for plunge cuts							
Side set, ground	HCS	150	1,25	4,0 mm/ 6 TPI	S 644 D	2	631120000*
						5	631470000*
						100	631458000*
 Wood 10-250 mm, chipboard 10-100 mm, plywood, plastics							
Side set, ground	HCS	300	1,25	4,0 mm/ 6 TPI	S 1344 D	2	631122000*
						5	631472000*
 Wood (also damp) 15-190 mm, firewood, removal of branches							
side set, ground, carbide-coated	HCS	240	1,5	5,0 mm/ 5 TPI	S 1531 L	2	631139000*
						5	631488000*
						25	628245000*
 Wood (also moist) 15-100 mm, firewood 15-90 mm							
side set, ground, carbide-coated	HCS	240	1,5	8,5 mm/ 3 TPI	S 1542 K	2	631141000*
						5	631490000*

"Universal wood" sabre saw blades

- Universal and quick in both thick and thin material

Version	Material finish	Overall length mm	Thickness mm	Tooth pitch	Corresponds to Bosch type	Sales unit	Order no.
 Wood (also damp) 6-150 mm, chipboard 6-60 mm, plywood, plastics, specially designed for plunge cuts							
Side set, ground	HCS	200	1,25	2,5-4,3 mm/6-10 TPI/ Progressive	S 2345 X	2	631910000*
						5	631913000*

"Expert Inox" sabre saw blades

- Excellent service life and robustness thanks to carbide toothed strip
- Ideal for cuts in stainless steel thanks to particularly finely ground carbide teeth

Version	Material finish	Overall length mm	Thickness mm	Tooth pitch	Corresponds to Bosch type	Sales unit	Order no.
 Stainless steel sheets (Inox) 2-4 mm, stainless steel profiles 2-50 mm, plastic (glass fibre reinforced plastic)							
HM strip, ground	HM	115	1,25	1,4 mm/ 18 TPI	S 522 EHM	2	631817000*

"Expert cast iron" sabre saw blades

- Very long tool life thanks to carbide coating (grit 30)
- Especially for use in cast steel pipes, brickwork, glassfibre-reinforced plastic and epoxy

Version	Material finish	Overall length mm	Thickness mm	Tooth pitch	Corresponds to Bosch type	Sales unit	Order no.
 Cast steel pipe Ø max. 6", stone, plastic (glass fibre reinforced plastic)							
	Carbide, coated	225	1,25	Grain size 30	S 1130 Riff	2	631818000*



"Expert cast iron premium" sabre saw blades

- Excellent tool life thanks to diamond coating (grit 50)
- Especially for use in cast pipes (also with cement lining), glassfibre-reinforced plastics, epoxy and very abrasive materials

Version	Material finish	Overall length mm	Thickness mm	Tooth pitch	Corresponds to Bosch type	Sales unit	Order no.
 Cast iron, pipes, metal, glassfibre-reinforced plastics, glass-fibre reinforced plastics							
	RD, coated	200	1	Grain size 50	S 1050 RD	2	NEW 626565000*



"Expert fibre plaster" sabre saw blades

- Individually welded-on carbide teeth for excellent service life
- Especially for use in porous concrete, brickwork, fibre-reinforced cement and glassfibre-reinforced plastic

Version	Material finish	Overall length mm	Thickness mm	Tooth pitch	Corresponds to Bosch type	Sales unit	Order no.
 Aerated concrete 6-100 mm, stone 6-100 mm, fibre cement, glass fibre reinforced plastic							
Carbide-tipped, side-set	HM	150	1,25	4,3 mm/ 6 TPI	S 641 HM	1	631137000*
 Porous concrete, brickwork 10-250 mm, fibre cement, glass fibre reinforced plastic							
Carbide-tipped, side-set	HM	300	1,5	8,5 mm/ 3 TPI	S 1241 HM	1	631146000*
 Porous concrete, brickwork 20-350 mm, fibre cement, glass fibre reinforced plastic							
Carbide-tipped, side-set	HM	400	1,5	12,7 mm/ 2 TPI	S 2041 HM	1	631819000*



"Expert brick" sabre saw blades

- Individually welded-on carbide teeth for excellent service life
- Especially for use in masonry, clinker, porous concrete and cement composite boards

Version	Material finish	Overall length mm	Thickness mm	Tooth pitch	Corresponds to Bosch type	Sales unit	Order no.
 Masonry, brickwork, porous concrete, cement board, for material thicknesses <150 mm	HM	240	1,5	12,7 mm/ 2 TPI	S 1543 HM	1	631916000*
 Masonry, brickwork, porous concrete, cement board, for material thicknesses <215 mm	HM	305	1,5	12,7 mm/ 2 TPI	S 1243 HM	1	631917000*
 Masonry, brickwork, porous concrete, cement board, for material thicknesses <365 mm	HM	455	1,5	12,7 mm/ 2 TPI	S 2243 HM	1	631918000*

"Expert plaster" sabre saw blades

- Especially for use in special materials such as gypsum plaster
- Splinter-free curved cuts thanks to finely ground teeth

Version	Material finish	Overall length mm	Thickness mm	Tooth pitch	Corresponds to Bosch type	Sales unit	Order no.
 Gypsum plaster, for clean cuts	BiM	100	0,9	4,2 mm/ 6 TPI	S 528 DF	5	628264000*
 Gypsum plaster 8-100 mm, for clean cuts	BiM	150	1,25	4,3 mm/ 6 TPI	S 628 DF	5	631907000*

"Expert fibre insulation" sabre saw blades

- Especially for use in special materials such as mineral wool, foams (EPS/PUR), Styrodur, polystyrene, leather, rubber, paper, carpet
- Fast and clean cuts thanks to blade edge with double serrated edge

Version	Material finish	Overall length mm	Thickness mm	Tooth pitch	Corresponds to Bosch type	Sales unit	Order no.
 Insulation material, rubber, cardboard, styropor, carpets	HCS	300	1,27	Blade edge	S 1213 AWP	NEW	626563000*



"Expert soft materials" sabre saw blades

- Especially for use in special materials such as cardboard, polystyrene, insulating material
- Splinter-free cutting results thanks to serrated blade edge

Version	Material finish	Overall length mm	Thickness mm	Tooth pitch	Corresponds to Bosch type	Sales unit	Order no.
 Cardboard, polystyrene, insulation materials	HCS	150	1	Blade edge	S 713 AW	2	631144000*





Saw blades for wood

- Clean plunge cuts in wood
- Convex row of teeth for easy starting and clean cutting results
- Plunge saw blade with lasered depth scale for precise immersion depths

Holder	Material	Length mm	Width mm	Tooth pitch	Sales unit	Order no.
 Soft wood	HCS	45	32	1,3 mm/20 TPI	1	626950000*
					5	626951000*
 Coated boards, laminated flooring, for clean cuts	BiM	45	32	1,8 mm/14 TPI	1	626956000*
					1	626946000*
 Soft wood	HCS	60	32	1,4 mm/18 TPI	1	NEW 626946000*
					1	

Saw blades for wood and metal

- High-quality Bi-metal serration for long service life and high cutting quality
- Plunge saw blade with lasered depth scale for precise immersion depths



Holder	Material	Length mm	Width mm	Diameter	Tooth pitch	Sales unit	Order no.
 Soft wood, hard wood, wood with nails, coated boards, plastic	BiM	30	20	-	1,3 mm/20 TPI	1	626952000*
						5	626954000*
 Soft wood, hard wood, wood with nails, coated boards, plastic	BiM	45	32	-	1,3 mm/20 TPI	1	626953000*
						5	626954000*
 Soft wood, hard wood, wood with nails, coated boards, plastic	BiM	35	65	-	1,3 mm/20 TPI	1	626955000*
						1	626960000*
 Soft wood, hard wood, wood with nails, coated boards, plastic, profiles	BiM	-	-	85	1,3 mm/20 TPI	1	626960000*
						1	626945000*
 Soft wood, hard wood, wood with nails, coated boards, plastic	BiM	60	32	-	1,3 mm/20TPI	1	NEW 626945000*
						1	

*Self-service packaging

*Self-service packaging

Saw blades for metal

- High-quality serration for long service life and high cutting quality
- Plunge saw blade with lasered depth scale for precise immersion depths

	Holder	Material	Length mm	Width mm	Tooth pitch	Sales unit	Order no.
Copper profiles, aluminium profiles, NF metal coated materials, nails	 STARLOCK	BiM	45	32	1,3 mm/20 TPI	1	626957000*
						5	626958000*
Metal, stainless steel, hardened screws and nails	 STARLOCK	HM	35	32	1,3 mm/20 TPI	1	626959000*
Metal, stainless steel, hardened screws and nails	 STARLOCK PLUS	HM	50	32	1,3 mm/20 TPI	1	NEW 626948000*





Scraper

- Durable HCS blade for universal use

	Holder	Material	Length mm	Width mm	Tooth pitch	Sales unit	Order no.
Tile adhesive, carpets, carpet adhesive	 STARLOCK		25	52		1	626961000*



Accessories for special applications "Expert"

- High-quality carbide coating for high material removal and long service life

	Holder	Material	Diameter mm	Tooth pitch	Sales unit	Order no.
Remove tile grooves, putty, tile adhesive, carpet adhesive	 STARLOCK	Carbide, coated	85	Riff 30	1	626962000*
For clean cuts, especially for plunge cuts, glassfibre-reinforced plastics, fibreboards, gypsum plaster, metal, stainless steel	 STARLOCK PLUS	HM		1,3 mm/20 TPI	1	NEW 626947000*
For straight, precise and especially clean cuts, fibreboards, glassfibre-reinforced plastics, gypsum plaster, plastics, cement fibreboards	 STARLOCK PLUS	Carbide, coated		Riff 40	1	NEW 626949000*
Putty, tile adhesive, carpet adhesive, mortar, rough wood removal	 STARLOCK	Carbide, coated	78	Riff 30	1	626963000*

*Self-service packaging

Assortments for multi-tools

	Order no.
 <p>Tiler's set</p> <ul style="list-style-type: none"> ■ Tiler's set for varied renovation and conversion applications, such as removal of mortar or tile adhesive, removal of grout in wall and floor tiles, cutting of smaller cut-outs in soft wall tiles ■ Set comprising: 1 x carbide segment saw blade 85 mm (tiles), 1 x carbide triangular sanding pad 78 mm (tiles), 1 x scraper rigid 52 mm HCS, 1 x plunge saw blade 32 mm BiM (metal) <p>STARLOCK</p>	626419000*
 <p>Interior finishing set</p> <ul style="list-style-type: none"> ■ Interior finishing set for varied floor and installation applications, such as cutting of laminate/parquet, shortening door frames at floor level, plunge cuts in coated boards, wood, cutting of apertures in furniture elements ■ Set comprising: 1 x plunge saw blade 32 mm HCS (wood), 1 x segment saw blade 85 mm BiM (wood + metal), 1 x scraper rigid 52 mm HCS, 1 x plunge saw blade 32 mm BiM (metal) <p>STARLOCK</p>	626420000*

Hook and loop sanding sheets for wood and metal, »professional« series



- High-quality sanding paper with semi-open coarseness and high removal of material for a homogenous finish
- For veneers, solid wood, polyester, steel and stainless steel sheets, non-ferrous metals, light alloys
- For sanding veneered cabinet fronts and sides, sanding furniture covered with veneers with hot-melt type adhesive edges, decorative sanding of stainless steel sheets, sanding-based repair work, and deburring cut sheet metal

	Dimensions mm	Grit	Sales unit	Order no.
	93 x 93	P 40	5	624940000*
	93 x 93	P 60	5	624941000*
	93 x 93	P 80	5	624942000*
	93 x 93	P 100	5	624943000*
	93 x 93	P 120	5	624944000*
	93 x 93	P 180	5	624945000*
	93 x 93	P 240	5	624946000*
	93 x 93	P 320	5	624947000*
	93 x 93	P 40	25	624980000
	93 x 93	P 60	25	624981000
	93 x 93	P 80	25	624982000
	93 x 93	P 100	25	624983000
	93 x 93	P 120	25	624984000
	93 x 93	P 180	25	624985000
	93 x 93	P 240	25	624986000
	93 x 93	P 320	25	624987000
	Assortment (10 x P 60, 10 x P 80, 5 x P 120)		25	624988000

Hook and loop sanding sheets for paints and lacquers, »professional« series



- High-quality sanding paper with semi-open coarseness and high removal of material
- Suitable for working with paints and lacquers of all types and filler compounds
- For deburring, cleaning veneers, solid woods, plywood, and lacquers, deburring furniture veneer

	Dimensions mm	Grit	Sales unit	Order no.
	93 x 93	P 40	25	625681000
	93 x 93	P 60	25	625682000
	93 x 93	P 80	25	625683000
	93 x 93	P 120	25	625685000
	93 x 93	P 180	25	625686000
	93 x 93	P 240	25	625687000
	93 x 93	P 320	25	625688000

*Self-service packaging

Hook and loop abrasive nylon web, corundum abrasive



- Used for structuring wood (applying a rustic appearance), for removing rust from metal and for sanding paints (tarnishing)

Grit	Order no.
P 100	624958000*
P 280	624959000*

Additional accessories for multi-tools



Triangular sanding plate

- Perforated hook and loop sanding pad
- Quick, easy change of the sanding sheets
- For multi-tool .Dimension from corner to corner: 93 mm
- OIS compatible

Order no.
626421000*



"Starlock" triangular sanding plate

- Low-dust working thanks to special extraction opening
- Quick, easy change of the sanding sheets
- For multi-tool .Dimension from corner to corner: 93 mm

Order no.
626944000*

NEW

STARLOCK

Additional accessories for multi-tools



Set depth guide + extraction nozzle for MT 18 LTX BL QSL

- Depth guide for precise working depth and working near edges: easy and fast installation, angle adjustable
- Extraction nozzle for the dust extraction: can be used on both sides of the machine

Order no.
626943000*

NEW

Band saw blades

Band saw blades for wood and plastic

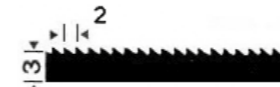

A2 Helical tooth for small radii
Wood, plastic, fine sawing attachment required



A4 Helical tooth for curved cuts
Wood, plastic



A6 Peg tooth for curved cuts
Wood, plastic



A6 Helical tooth for straight cuts
Wood, plastic



A6 Helical tooth for straight cuts
Wood, plastic

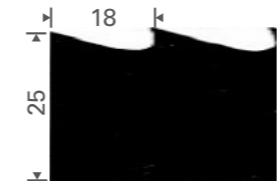

A18 Helical tooth for straight cuts
Firewood

Band saw blades for metal and foam materials



A2 Rake tooth for universal cuts
Aluminium, copper, brass, foam materials



14TPI **14/18 TPI** **18TPI** Rake tooth for universal cuts
Aluminium, copper, brass, steel

Designation of the band saw blades

Example:

Top edge induction hardened.
2240 x 6 x 0,5/A - 4 (14 TPI)

Top edge induction hardened. = tooth tip induction hardened
Carbon steel with induction hardened tooth tips;
very economical thanks to high useful life

2240 = band length mm
6 = band width mm
0,5 = band thickness mm
A - 4 = clearance of tooth tips mm
14 TPI = A2 = number of teeth per inch unit
1,3 TPI = A18 = number of teeth per inch unit

Band saw blades for wood and plastic



- Carbon steel with induction hardened teeth
- Very economical due to its long useable working life

Dimensions mm	Tooth pitch	Material suitability	Suitable for	Order no.
1.505 x 6 x 0,36	A4 helical tooth	Wood, plastics, aluminium, especially for curved cuts	BS 230 up to 2001	0909040817*
1.505 x 12 x 0,36	A6 peg tooth	Wood, plastics, aluminium	BS 230 up to 2001	0909040825*
1.712 x 6 x 0,36	A4 helical tooth	Wood, plastics, aluminium, especially for curved cuts	BAS 260 Swift	0909057175*
1.712 x 12 x 0,36	A6 peg tooth	Wood, plastics, aluminium	BAS 260 Swift	0909057183*
1.810 x 6 x 0,35	A4 helical tooth	for curved cuts (curves), wood, wood-like materials, plastics	BS 5370, BS 5378	627641000*
1.810 x 10 x 0,35	A6 peg tooth	for curved cuts with larger radius, wood, wood-like materials, plastics	BS 5370, BS 5378	627642000*
1.810 x 13 x 0,35	A6 peg tooth	for long, straight cuts, wood, wood-like materials, plastics	BS 5370, BS 5378	627643000*
2.225 x 3 x 0,65	A2 helical tooth	Wood, plastics, especially for curved cuts, for circular cuts with fine sawing equipment	BAS 380	0909060257*
2.225 x 6 x 0,36	A4 helical tooth	Wood, plastics, especially for curved cuts	BAS 380	0909060265*
2.225 x 9 x 0,36	A6 peg tooth	Wood, plastics	BAS 380	0909060273*
2.225 x 13 x 0,36	A6 peg tooth	Wood, plastics, for straight and clean cuts	BAS 380	0909060281*
2.230 x 3,5 x 0,65	A2 helical tooth	for curved cuts (curves), wood, wood-like materials, plastics	Bs 0633	630852000*
2.230 x 6 x 0,65	A4 helical tooth	for long, straight cuts, for curved cuts with larger radius, wood, wood-like materials, plastics	Bs 0633	630850000*
2.230 x 12,5 x 0,65	A6 peg tooth	for long, straight cuts, wood, wood-like materials, plastics	Bs 0633	630851000*
2.230 x 15 x 0,8	A6 peg tooth	for long, straight cuts, wood, wood-like materials, plastics	Bs 0633	630855000*
2.240 x 6 x 0,5	A4 helical tooth	Wood, plastics, especially for curved cuts	BAS 317 Precision	0909029252*
2.240 x 12 x 0,5	A6 peg tooth	Wood, plastics	BAS 317 Precision	0909029244*
2.240 x 15 x 0,5	A6 peg tooth	Wood, plastics, for straight and clean cuts	BAS 317 Precision	0909029260*
2.240 x 15 x 0,5	A2 rake tooth	Wood, plastics, aluminium	BAS 317 Precision	0909029279*
3.380 x 6 x 0,5	A4 helical tooth	Wood, plastics, especially for curved cuts	BAS 505 G, BAS 505 Precision	0909029180*
3.380 x 15 x 0,5	A6 peg tooth	Wood, plastics	BAS 505 G, BAS 505 Precision	0909029171*
3.380 x 25 x 0,5	A6 peg tooth	Wood, plastics, for straight and clean cuts	BAS 505 G, BAS 505 Precision	0909000416*
3.380 x 25 x 0,5	A18 peg tooth	Wood, firewood	BAS 505 G, BAS 505 Precision	0909000424*
3.380 x 15 x 0,5	A2 rake tooth	Wood, plastics	BAS 505 G, BAS 505 Precision	0909029210*

Band saw blades for metal



- Carbon steel with induction hardened teeth
- Very economical due to its long useable working life

Dimensions mm	Tooth pitch	Material suitability	Suitable for	Order no.
835 x 13 x 0,5	14 TPI	Metal, profiles, plastics, foams	MBS 18 LTX 2.5	626427000
835 x 13 x 0,5	18 TPI	Metal, profiles, plastics, foams	MBS 18 LTX 2.5	626428000
835 x 13 x 0,5	14/18 TPI	Metal, profiles, plastics, foams	MBS 18 LTX 2.5	626429000
1.067 x 5 x 0,65	A2 rake tooth	NF metals, plastics, aluminium, wood	BS 150 E up to 1998	0909052939*
1.505 x 12 x 0,36	A2 rake tooth	NF metals, plastics, wood	BS 230 up to 2001	0909040841*
1.712 x 12 x 0,36	A2 rake tooth	NF metals, plastics, aluminium, wood	BAS 260 Swift	0909057191*
1.810 x 6 x 0,35	24 TPI	for straight and clean cuts, aluminium, aluminium profiles, NF metals	BS 5370, BS 5378	627644000*
2.230 x 3 x 0,65	18 TPI	Profiles, sheet steel	Bs 0633	630853000*
2.230 x 10 x 0,65	4 TPI	Aluminium, NF metals	Bs 0633	630854000*
2.230 x 13 x 0,65	14 TPI	Metal	Bs 0633	630858000*
3.380 x 13 x 0,65	14 TPI	NF metals coated materials, plastics	BAS 505 G	0909029228*

Machine stand



- Machine stand UMS**
- For ideal working height and stability
 - Can be folded up compactly
 - Compensation in height with adjustable stand
 - Ready mounted
- Height of work bench: 83 cm
Weight: 12 kg
Maximum weight load: 250 kg
Support surface 57 x 60 cm
Suitable for: KS 216 M Lasercut, KGS 216 M, KGS 254 M, KGS 216 Plus, KGS 254 Plus / KGS 254 I Plus, KGS 315 Plus, KS 254 Plus, KS 305 Plus, KS 305 M, KGT 300, KGT 305 M, BAS 260 Swift, BAS 261 Precision, DH 330

Order no.

631317000

Circle cutting attachments



- Circle cutting attachment**
- For circular cuts or tapered cuts (with inclined table)
 - Diameter from 120 to 280 mm
- Band saw blade 6 mm required for curve sawing
Suitable for: BAS 315 / 316, BAS 316 G, BAS 317 Precision, BAS 450, BAS 500, BAS 505 G, BAS 600, BAS 505 Precision, BAS 260 Swift

Order no.

0909031249*



- Circle cutting attachment**
- Max. passage height:
BAS 261 Precision: 30 mm
BAS 318 Precision: 105 mm
- For circular cuts or tapered cuts (with inclined table)
Band saw blade 6 mm required for curve sawing
Suitable for: BAS 261 Precision, BAS 318 Precision

631327000

Belt sanding attachment



- Belt sanding attachment**
- For regrinding surfaces and curved sawing cuts
Suitable for: BAS 318 Precision

Order no.

631333000

Cloth Sanding Belts





Grit	Dimensions mm	Sales unit	Suitable for	Order no.
P 80	20 x 2.205	3	BAS 380	0909060303*
P 80	20 x 2.240	3	BAS 315 / 316, BAS 316 G, BAS 317 Precision, BAS 318 Precision	0909030528*
P 120	20 x 2.240	3	BAS 315 / 316, BAS 316 G, BAS 317 Precision, BAS 318 Precision	0909030536*
P 80	25 x 3.380	3	BAS 450, BAS 500, BAS 505 G, BAS 600, BAS 505 Precision	0909030544*
P 120	25 x 3.380	3	BAS 450, BAS 500, BAS 505 G, BAS 600, BAS 505 Precision	0909030552*



Hook and Loop Sanding Sheets



Grit	Diameter mm	Sales unit	Suitable for	Order no.
P 60	200	5	BAS 380	0909060338*
P 80	200	5	BAS 380	0909060346*
P 100	200	5	BAS 380	0909060354*

Accessories for circular saws

Stands		Order no.
	<p>TSU Stand</p> <ul style="list-style-type: none"> For ideal working height and stability Foldable <p>Weight: 5.9 kg Max. load with attached machine: 125 kg (machine + work-piece) Suitable for: TS 254 M</p>	629003000
NEW		
	<p>Machine stand UMS</p> <ul style="list-style-type: none"> For ideal working height and stability Can be folded up compactly Compensation in height with adjustable stand Ready mounted <p>Height of work bench: 83 cm Weight: 12 kg Maximum weight load: 250 kg Support surface 57 x 60 cm Suitable for: KS 216 M Lasercut, KGS 216 M, KGS 254 M, KGS 216 Plus, KGS 254 Plus / KGS 254 I Plus, KGS 315 Plus, KS 254 Plus, KS 305 Plus, KS 305 M, KGT 300, KGT 305 M, BAS 260 Swift, BAS 261 Precision, DH 330, KGSV 72 Xact / KGSV 72 Xact SYM</p>	631317000

Sliding Table		Order no.
	<p>TKHS sliding table</p> <ul style="list-style-type: none"> Enables exact cuts, even on larger workpieces Precise sliding table on 6 ball bearings Complete with fence guide, swivels 90-45° Fence pointer for precise repeated cuts <p>Suitable for: TKHS 315, TKHS 315 C, TKHS 315 M Maximum cutting width 90°/45°: 640 mm/930 mm Overall length: 1,270 mm Support weight: 24 kg</p>	0910058967
	<p>Sliding table TS</p> <ul style="list-style-type: none"> Clean and precise cutting results Smooth guidance via four castors Including fence guide <p>Suitable for: TS 254, TS 254 M, TS 36-18 LTX BL 254, TS 36 LTX BL 254, TS 216, TS 216 Floor Table size: 300 x 185 mm Overall length: 1,092 mm</p>	628900000
NEW		

Chip extraction adapter nozzle		Order no.
	<p>Chip extraction adapter nozzle BKS</p> <ul style="list-style-type: none"> For connecting the site saws to a chip and dust extraction unit <p>Extraction nozzle Ø: 100 mm Suitable for: BKS 400, BKS 400 Plus, BKS 450, BKS 450 Plus</p>	0910008749

Stands for mitre saws: ideal for the construction site and the workshop.

All Metabo mitre saws, as well as all standard models of renowned manufacturers, can be mounted on the light and robust KSU 401, and KSU 251 stands, quickly and without tools. Thanks to the trolley function, which Metabo designed for construction sites and staircases, the large handles and the ability to fold the legs with one only hand, has optimised the stands for transport. Even with the saw mounted, the stands can be folded with just a few hand movements and can be comfortably pulled to and from the workplace. They are extremely robust and stable and are suitable both for use on construction sites as well as in the workshop.

Robust and light design
with max. weight load in central part of 250 kg

Extendable workpiece supports
up to 400 cm with rollers and folding guide for precise cutting in series

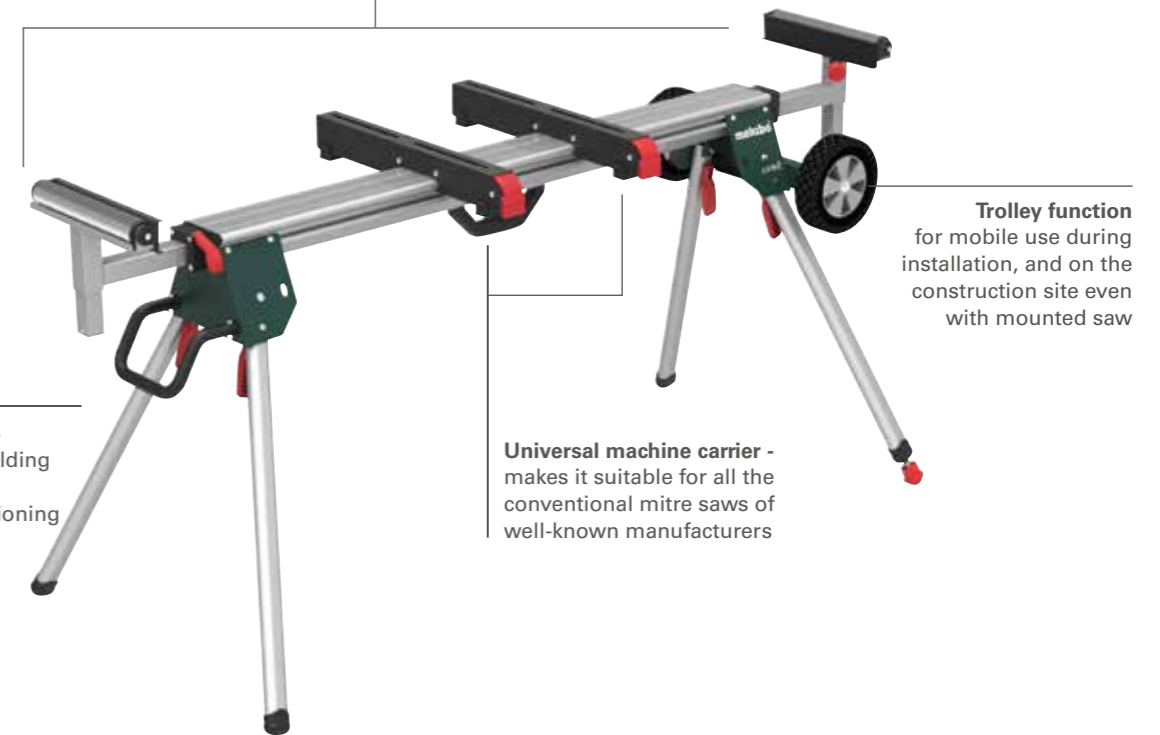

Quickly ready to use
thanks to lockable folding legs and adjustment option for safe positioning

Universal machine carrier - makes it suitable for all the conventional mitre saws of well-known manufacturers

Trolley function
for mobile use during installation, and on the construction site even with mounted saw

KSU 401



KSU 251:
Compact design for easy transport









Trolley function
for comfortable transport even with the saw mounted



Folding function by actuating lever
for quick, single-handed folding and unfolding

Special accessories for mitre saws

	Order no.
 <p>Stand for mitre saws KSU 251 Mobile</p> <ul style="list-style-type: none"> Particularly robust stand for mitre saws with trolley function for mobile use also with mounted saw Extendable workpiece supports with rollers and folding guide for precise cutting in series Double supported table width extension for heavy workpieces Compensation in height with adjustable feet Simple folding mechanism; can be folded even with the saw in place Space-saving storage position Including machine carrier (installation without tools) makes it suitable for all the conventional mitre saws of well-known manufacturers <p>Overall length: 121 cm – 240 cm Height of workpiece supports: 86cm Maximum weight load in central part: 180 kg Weight: 31 kg</p>	629007000
 <p>KSU 251 Stand for mitre saws</p> <ul style="list-style-type: none"> Light and robust stand for mitre saws with trolley function for mobile use also with mounted saw Quickly ready to use thanks to lockable folding legs and adjustment option for safe positioning Extendable workpiece supports with rollers and folding guide for precise cutting in series Including machine carrier (installation without tools) makes it suitable for all the conventional mitre saws of well-known manufacturers Overall length: 127 cm – 250 cm Height of workpiece supports: 92 cm - 99 cm Maximum weight load in central part: 250 kg Weight: 23 kg 	629005000
 <p>Stand for mitre saws KSU 100</p> <ul style="list-style-type: none"> Light and robust stand for mitre saws Quickly ready to use thanks to lockable folding legs Extendable workpiece supports with rollers and folding guide for precise cutting in series (available as accessory) Machine carrier (installation without tools) makes it suitable for all the conventional mitre saws of well-known manufacturers Including 1 pair of machine carriers (629008000) Overall length: 100 cm Maximum weight load in central part: 250 kg Weight: 16 kg 	629004000
 <p>KSU 401 Stand for mitre saws</p> <ul style="list-style-type: none"> Light and robust stand for mitre saws with trolley function for mobile use also with the saw mounted Quickly ready to use thanks to lockable folding legs and adjustment option for safe positioning Extendable workpiece supports with rollers and folding guide for precise cutting in series Machine carrier (installation without tools) makes it suitable for all the conventional mitre saws of well-known manufacturers Including 1 pair of machine carriers (629008000) Overall length: 168 cm - 400 cm Height of workpiece supports: 92 cm - 99 cm Maximum weight load in central part: 250 kg Weight: 25 kg 	629006000
 <p>Machine carrier KSU 100/251/401</p> <ul style="list-style-type: none"> For the easy and safe installation of tall standard mitre saws of renowned manufacturers on the machine stands KSU 251 and KSU 401 Contents: 2 pieces 	629008000
 <p>Workpiece support KSU 100</p> <ul style="list-style-type: none"> 1 extendable workpiece support with rolls and foldable guide for precise cuts in series Can be used left or right 	629009000

Accessories for planing machines

Disposable reversible planer blades



- For all soft woods

Dimensions mm	Suitable for	Sales unit	Order no.
260 x 18,6 x 1	HC 260 C, HC 260 M, HC 260 K	2	0911030713*
260	ADH 260	2	630468000

HSS planer blade



- For all soft woods and hard woods
- Regrindable
- 18% tungsten = increased tool life

Dimensions mm	Suitable for	Sales unit	Order no.
260 x 20 x 2,5	Multi 260	2	0920054030*
260 x 20 x 3	HC 260 C, HC 260 M, HC 260 K	2	0911030721*
263 x 24,5 x 3	HC 260 E / ES up to construction year 1989	2	0911030748*
304 x 25 x 3	HC 300	2	0911060167*
310 x 20 x 2,5	Multi 310	2	0920054048*
310 x 20 x 3	HC 333 G	2	0911053179*
310 x 30 x 3	HC 314 up to construction year 1999	4	0911016362*
320 x 25 x 3	HC 320 up to construction year 1999	3	0911014220*
334 x 16 x 2	DH 330 up to construction year 2005	2	0911062119*
332 x 12 x 1,5	DH 330 as of year of construction 2006, DH 316	2	0911063549*
410 x 25 x 3	HC 410 G	3	0911050390*
260	ADH 260	2	630467000
260	ADH 1626	2	630545000

Carbide planer blade



- For all hard woods, especially exotic woods, laminated wood, hard paper, fabric reinforced laminates
- Panel materials and plastics
- Regrindable, long tool life

Dimensions mm	Suitable for	Sales unit	Order no.
260 x 20 x 3	HC 260 C, HC 260 M, HC 260 K	2	0911030730*

Planer blade and retaining strip conversion set



Dimensions mm	Suitable for	Sales unit	Order no.
260	HC 260 C, HC 260 M	2	0911030845

Wheel sets



- Wheel set**
- For easy transportation
- Suitable for: HC 260 C, HC 260 M

Order no.
0911003783

General accessories for woodworking

Roller stands



Roller stand RS 420
 ■ For supporting long workpieces when sawing, moulding/routing, planing and drilling
 ■ Sturdy, height-adjustable and foldable
 With smooth-rolling rollers with a high load capacity
 Width: 400 mm
 Base weight: 100 kg
 Height: 640 - 1,015 mm

Order no.
0910053353

Spray for maintenance and care



Spray for maintenance and care
 ■ Ideal for maintenance and care of wood processing machines
 ■ Contains silicone, prevents saw dust from sticking, e.g. to threaded rods or sliding bearings
 ■ Increases the sliding quality of the workpieces on the machine table
 ■ High cleaning capacity
 Contents: 400 ml

Order no.
0911018691*

Lubricant

- To help the wood glide well on the dressing plate and the thickness table



Waxilit - lubricant
 Weight: 70 g

Order no.
0911001071



Waxilit - lubricant
 Weight: 1,000 g

Order no.
4313062258

Abrasive media: high removal and durable

Proven quality for professional use: for processing surfaces like wood, metal, paint, stone.
 Also suitable for sanders of all common makes.

Structure and purpose

The sanding compound
 carries the abrasive grain and transmits the cutting forces. In addition to high strength and low elongation, the abrasive backing must have a flexibility adapted to the respective grinding process.

- Carriers are
- Highly compressed papers of various thicknesses.
 - Fabric based on polyester and cotton of various strengths.
 - Vulcanized fibre as a strong and tear-proof base is the base material for the (Vulcan) fibre disc.

The abrasive grain
 is the actual cutting tool. It penetrates the material being processed and removes the surface. The abrasive grain is anchored on to the grain-holding medium. High hardness, toughness and a sharp edged geometry are the most important attributes of the abrasive grain.

- Abrasive grain types are
- Corundum (aluminium oxide) as a hard, slightly brittle grain for the processing of metal, wood, varnish, etc.
 - Silicon carbide as a hard, sharp-edged abrasive grain for the processing of lacquer, wood, ceramic, glass and rubber etc.
 - Zirconia Alumina as a tough and fine crystalline combination of aluminium oxide and aluminium zircon for the processing of metal and non-rusting materials.

The bonding agent
 anchors the abrasive grain in the sanding compound carrier and supports it against the forces generated by the removal of the surface.

- Bonding agents are
- Phenolic resins and partially synthetic resins for sufficient support

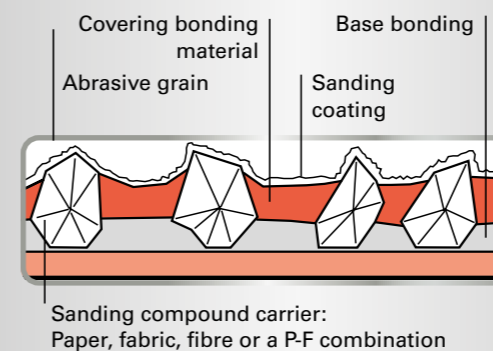

The quality of Metabo sanding media



- e.g. for random orbital sanders:
Wood + metal »professional«
E-paper, pink aluminium oxide, resin bonded
 ■ High-quality sanding paper with high coarseness and high removal of material
 ■ For best results when sanding wood and metal for professional use

Application:
 For veneers, solid wood, polyester, steel and stainless steel sheets, non-ferrous metals, light alloys



- For example, for orbital sanders:
Wood »classic«
A/B paper, aluminium oxide, resin/glue bond
 ■ High-quality sanding paper with semi-open coarseness

Application:
 For wood generally, solid wood, veneers, plastic, acrylic glass, lacquer, spatula, fillers, e.g. for deburring, cleaning of plywood, veneer, solid wood, lacquered surfaces, deburring of veneered furniture edges



- For example, for triangular base-plate sanders:
Paint »professional«
B/C paper, pink grade corundum, stearate-coated, resin bonded
 ■ High-quality sanding paper with semi-open coarseness and high removal of material
 ■ The special stearate coating ensures a long service life by not clogging the sanding medium

Application:
 For best results when sanding off paint, lacquer, body-filler on wood or metal on professional application

*Self-service packaging

17
18
19
20
21
22
23
24
25
26
27
28
29
30
31
32

Accessories for random orbital sander

Hook and loop backing pad

	Diameter mm	Hardness	Version	Suitable for	Order no.
	80	Medium-hard	Perforated	SX E 400	624064000*
	122	Medium	Perforated	FSX 200 Intec	625658000*
	122	Medium-hard	Perforated	SX E 125	631224000*
	125	Soft	Multi-hole	SXE 325 Intec, SX E 425, SXE 425 TurboTec	631220000*
	125	Medium-hard	Multi-hole	SXE 3125	624739000*
	150	Soft	Multi-hole	SXE 450 TurboTec	631156000*
	150	Medium-hard	Perforated (6 or 8 holes)	SXE 450 TurboTec	631150000*
	125	Medium-hard	Multi-hole	SXE 150-2.5 BL, SXE 150-5.0 BL	630264000*
	150	Medium-hard	Multi-hole	SXE 150-2.5 BL, SXE 150-5.0 BL	630259000*
	125	Medium-hard	Multi-hole	SXE 425 TurboTec, SXE 3125, SXA 18 LTX 125 BL, PowerMaxx SXA 12-125 BL	630261000*
	150	Medium-hard	Multi-hole	SXE 450 TurboTec, SXE 3150	630262000*
	150	Medium-hard	Perforated (6 or 8 holes)	SXE 3150	624740000*

*Self-service packaging

Hook and loop intermediate discs



- Hook and loop intermediate disc for particularly soft delicate working, for sanding of curved surfaces and contours, has damping element between sanding paper and sanding pad

	Diameter mm	Hardness	Version	Suitable for	Order no.
	80	Soft	Perforated	SX E 400	624061000*
	125	Soft	Unperforated	SX E 425, SXE 325 Intec, FSX 200 Intec, SXE 425 TurboTec, SXE 3125	631216000*
	150	Soft	Unperforated	SXE 3150, SX E 450 Duo, SXE 450 TurboTec, SXE 3150	624037000*
	150	Soft	Multi-hole	SXE 150-2.5 BL, SXE 150-5.0 BL	630260000*
	125	Soft	Multi-hole	SXE 150-2.5 BL, SXE 150-5.0 BL	630263000*

Hook and loop sanding sheets for wood and metal, »professional« series





- High-quality sanding paper with semi-open coarseness and high removal of material for a homogenous finish
- For veneers, solid wood, polyester, steel and stainless steel sheets, non-ferrous metals, alloys
- e.g. for sanding veneered cabinet fronts and sides, sanding furniture covered with liners with hot-melt type adhesive edges, decorative sanding of stainless steel sheets, sanding-based repair work, and deburring cut sheet metal

	Diameter mm	Grit	Sales unit	Order no.
	Hook and loop sanding sheets Ø 80 mm, 6 holes			
	80	P 40	10	624041000*
	80	P 60	10	624042000*
	80	P 80	10	624043000*
	80	P 100	10	624044000*
	80	P 120	10	624045000*
	80	P 180	10	624046000*
	80	P 240	10	624047000*
	80	P 320	10	624048000*
	80	P 40	25	624051000
	80	P 60	25	624052000
	80	P 80	25	624053000
	80	P 100	25	624054000
	80	P 120	25	624055000
	80	P 180	25	624056000
	80	P 240	25	624057000
	80	P 320	25	624058000
	80	P 400	25	624059000

Diameter mm	Grit	Sales unit	Order no.
 Hook and loop sanding sheets Ø 125 mm, 8 holes			
125	P 40	5	631226000*
125	P 60	5	631227000*
125	P 80	5	631228000*
125	P 120	5	631229000*
125	P 180	5	631230000*
125	P 240	5	631231000*
125	P 320	5	631236000*
125	P 40	25	631584000
125	P 60	25	631585000
125	P 80	25	631586000
125	P 120	25	631587000
125	P 180	25	631588000
125	P 240	25	631589000
125	P 320	25	631596000
125	P 400	25	631597000
 Hook and loop sanding sheets Ø 125 mm, "multi-hole"			
125	P 40	50	626848000
125	P 60	50	626849000
125	P 80	50	626850000
125	P 100	50	626851000
125	P 120	50	626852000
125	P 180	50	626853000
125	P 240	50	626854000
125	P 320	50	626855000
125	P 400	50	626856000
 Hook and loop sanding sheets Ø 150 mm, 6 holes			
150	P 40	5	624001000*
150	P 60	5	624002000*
150	P 80	5	624003000*
150	P 100	5	624004000*
150	P 120	5	624005000*
150	P 180	5	624006000*
150	P 240	5	624007000*
150	P 320	5	624008000*
150	P 40	25	624019000
150	P 60	25	624020000
150	P 80	25	624021000
150	P 100	25	624022000
150	P 120	25	624023000
150	P 180	25	624024000
150	P 240	25	624025000
150	P 320	25	624026000
150	P 400	25	624027000

Diameter mm	Grit	Sales unit	Order no.
 Hook and loop sanding sheets Ø 150 mm, "multi-hole"			
150	P 40	50	626674000
150	P 60	50	626675000
150	P 80	50	626676000
150	P 100	50	626677000
150	P 120	50	626678000
150	P 180	50	626679000
150	P 240	50	626680000
150	P 320	50	626681000
150	P 400	50	626682000

Assortment of sanding sheets for wood and metal, »professional« series

	Order no.
 25 Hook and loop sanding sheets Assortment (10 x P 60, 10 x P 80, 5 x P 120) Diameter: 80 mm Version: perforated (6 holes) Sales unit: 25	624060000
 6 Hook and loop sanding sheets Assortment (2 x P 60, 2 x P 120, 2 x P 240) Diameter: 125 mm Version: perforated (8 holes) Sales unit: 6	631232000*
 25 Hook and loop sanding sheets Assortment (10 x P 60, 10 x P 80, 5 x P 120) Diameter: 125 mm Version: perforated (8 holes) Sales unit: 25	631583000
 25 Hook and loop sanding sheets Assortment (10 x P 60, 10 x P 80, 5 x P 120) Diameter: 150 mm Version: perforated (6 holes) Sales unit: 25	624066000*
 Metaloc sanding media set "multi-hole" Metaloc includes 50 x P 80 (626676000), 50 x P 120 (626678000), 50 x P 180 (626679000) Diameter: 150 mm Version: multi-hole Sales unit: 150	626756000

*Self-service packaging

Hook and loop sanding sheets for paints and lacquers, »professional« series

- High-quality sanding paper with semi-open coarseness and high removal of material
- Suitable for working with paints and lacquers of all types and filler compounds
- e.g. for deburring, cleaning veneers, solid woods, plywood, and lacquers, deburring furniture veneer

Diameter mm	Grit	Sales unit	Order no.
Hook and loop sanding sheets Ø 80 mm, 6 holes			
80	P 40	25	624081000
80	P 60	25	624082000
80	P 80	25	624083000
80	P 100	25	624084000
80	P 120	25	624085000
80	P 180	25	624086000
80	P 240	25	624087000
80	P 320	25	624088000
Hook and loop sanding sheets Ø 125 mm, 8 holes			
125	P 40	25	625726000
125	P 60	25	625727000
125	P 80	25	625728000
125	P 120	25	625730000
125	P 180	25	625731000
125	P 240	25	625732000
125	P 320	25	625733000
125	P 400	25	625734000
Hook and loop sanding sheets Ø 125 mm, "multi-hole"			
125	P 40	50	626857000
125	P 60	50	626858000
125	P 80	50	626859000
125	P 100	50	626860000
125	P 120	50	626861000
125	P 180	50	626862000
125	P 240	50	626863000
125	P 320	50	626864000
125	P 400	50	626865000
Hook and loop sanding sheets Ø 150 mm, 6 holes			
150	P 40	25	624028000
150	P 60	25	624029000
150	P 80	25	624030000
150	P 100	25	624031000
150	P 120	25	624032000
150	P 180	25	624033000
150	P 240	25	624034000
150	P 320	25	624035000
150	P 400	25	624036000

Diameter mm	Grit	Sales unit	Order no.
Hook and loop sanding sheets Ø 150 mm, "multi-hole"			
150	P 40	50	626683000
150	P 60	50	626684000
150	P 80	50	626685000
150	P 100	50	626686000
150	P 120	50	626687000
150	P 180	50	626688000
150	P 240	50	626689000
150	P 320	50	626690000
150	P 400	50	626691000

Sanding sheet assortments for paints and lacquers, »professional« series

Order no.
626755000

Metaloc sanding media set "multi-hole"

- Corundum abrasive, stearate-coated
- For metal, filler compound, paints, filler

Metaloc includes 50 x P 80 (626685000), 50 x P 120 (626687000), 50 x P 180 (626688000)
 Diameter: 150 mm
 Version: multi-hole
 Sales unit: 150

Hook and loop polishing sponges

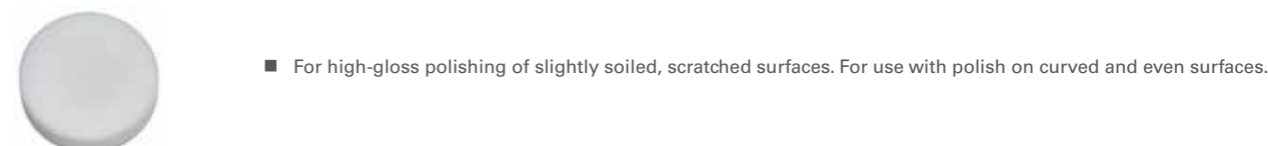

Diameter mm	Thickness mm	Sales unit	Order no.
80	20	1	624092000*
130	20	1	631222000*
160	20	1	631233000*

Hook and loop lambswool polishing discs







Diameter mm	Sales unit	Order no.
85	1	624063000*
160	1	631217000*
130	1	631223000*

*Self-service packaging

Accessories for sanders

Sanding sheets wood and metal, »professional« series



- High-quality sanding paper with semi-open coarseness and high removal of material
- For veneers, solid wood, polyester, steel and stainless steel sheets, non-ferrous metals, alloys
- For sanding veneered cabinet fronts and sides, sanding furniture covered with liners with hot-melt type adhesive edges, decorative sanding of stainless steel sheets, sanding-based repair work, and deburring cut sheet metal etc.

	Dimensions mm	Grit	Sales unit	Order no.
	Hook and loop sanding sheets 80 x 133 mm, 16 holes, with hook and loop			
NEW				
	80 x 133	P40	10	635190000
	80 x 133	P60	10	635191000
	80 x 133	P80	10	635192000
	80 x 133	P100	10	635193000
	80 x 133	P120	10	635194000
	80 x 133	P180	10	635195000
	80 x 133	P240	10	635196000
	Hook and loop sanding sheets 93 x 185 mm, 8 holes, with hook and loop			
	93 x 185	P 40	10	625765000*
	93 x 185	P 60	10	625766000*
	93 x 185	P 80	10	625767000*
	93 x 185	P 100	10	625768000*
	93 x 185	P 120	10	625769000*
	93 x 185	P 180	10	625770000*
	93 x 185	P 240	10	625771000*
	Sanding sheets 93 x 230 mm, 8 holes, for clamping			
	93 x 230	P 40	10	624480000*
	93 x 230	P 60	10	624481000*
	93 x 230	P 80	10	624482000*
	93 x 230	P 100	10	624483000*
	93 x 230	P 120	10	624484000*
	93 x 230	P 180	10	624485000*
	93 x 230	P 240	10	624486000*
	Hook and loop sanding sheets 103 x 115 mm, 6 holes, with hook and loop			
	103 x 115	P 40	10	625619000*
	103 x 115	P 60	10	625620000*
	103 x 115	P 80	10	625621000*
	103 x 115	P 100	10	625622000*
	103 x 115	P 120	10	625623000*
	103 x 115	P 180	10	625624000*
	103 x 115	P 240	10	625625000*
	Hook and loop sanding sheets 115 x 230 mm, 14 holes, with hook and loop			
	115 x 230	P 40	10	625786000*
	115 x 230	P 60	10	625787000*
	115 x 230	P 80	10	625788000*
	115 x 230	P 120	10	625790000*
	115 x 230	P 180	10	625791000*
	115 x 230	P 240	10	625792000*
	115 x 230	P 320	10	625793000*

*Self-service packaging

	Dimensions mm	Grit	Sales unit	Order no.
	Sanding sheets 115 x 280 mm, 14 holes, for clamping			
	115 x 280	P 40	10	624491000*
	115 x 280	P 60	10	624492000*
	115 x 280	P 80	10	624493000*
	115 x 280	P 120	10	624495000*
	115 x 280	P 180	10	624496000*
	115 x 280	P 240	10	624497000*

Assortment of sanding sheets for wood and metal, »professional« series

	Order no.
	624490000*
	625774000*
	625795000*

Sanding sheets for wood, »classic« series

- High-quality sanding paper with semi-open coarseness
- For all woods, solid wood, veneers, plastics, acrylics, lacquers, putty, filling compounds
- For deburring, cleaning of plywood, veneers, solid woods, lacquers and deburring furniture veneer etc.



	Dimensions mm	Grit	Sales unit	Order no.
	Sanding sheets 93 x 230 mm, 8 holes, for clamping			
	93 x 230	P 40	10	624826000*
	93 x 230	P 60	10	624827000*
	93 x 230	P 80	10	624828000*
	93 x 230	P 120	10	624830000*
	93 x 230	P 180	10	624831000*
	93 x 230	P 240	10	624832000*

Sanding sheets for paints and lacquers, »professional« series





- High-quality sanding paper with semi-open coarseness and high removal of material
- Suitable for working with paints and lacquers of all types and filler compounds
- For deburring, cleaning of plywood, veneers, solid woods, lacquers and deburring furniture veneer etc.

	Dimensions mm	Grit	Sales unit	Order no.
	Hook and loop sanding sheets 80 x 133 mm, 16 holes, with hook and loop			
NEW				
	80 x 133	P 40	10	635197000
	80 x 133	P 60	10	635198000
	80 x 133	P 80	10	635199000
	80 x 133	P 120	10	635201000
	80 x 133	P 180	10	635202000
	80 x 133	P 240	10	635203000

*Self-service packaging



Dimensions mm	Grit	Sales unit	Order no.
Hook and loop sanding sheets 93 x 185 mm, 8 holes, with hook and loop			
			
93 x 185	P 40	25	625881000
93 x 185	P 60	25	625882000
93 x 185	P 80	25	625883000
93 x 185	P 120	25	625885000
93 x 185	P 180	25	625886000
93 x 185	P 240	25	625887000
93 x 185	P 320	25	625888000
Hook and loop sanding sheets 103 x 115 mm, 6 holes, with hook and loop			
			
103 x 115	P 80	10	625641000*
103 x 115	P 120	10	625643000*
103 x 115	P 180	10	625644000*
103 x 115	P 240	10	625645000*
103 x 115	P 320	10	625646000*
Hook and loop sanding sheets 115 x 230 mm, 14 holes, with hook and loop			
			
115 x 230	P 40	25	625891000
115 x 230	P 60	25	625892000
115 x 230	P 80	25	625893000
115 x 230	P 100	25	625894000
115 x 230	P 120	25	625895000
115 x 230	P 180	25	625896000
115 x 230	P 240	25	625897000
115 x 230	P 320	25	625898000

Perforated hook and loop sanding pads

	Order no.
 NEW	
Sanding plate 80 x 133 mm <ul style="list-style-type: none"> Perforated, hook and loop sanding pads for PowerMaxx SRA 12 BL (as spare) Particularly effective extraction in combination with the textile dust bag (631369000) compact Quick change system of the sanding pad 	635204000*
	
Sanding plate 92 x 184 mm <ul style="list-style-type: none"> Perforated, hook and loop sanding pads for SR 2185 / SRE 3185 (as spare) 	624729000*
	
Sanding plate 112 x 230 mm <ul style="list-style-type: none"> Perforated, hook and loop sanding pad for SRE 4351 TurboTec (as spare) 	624737000*
	
Sanding plate 93 x 185 mm <ul style="list-style-type: none"> Perforated, hook and loop sanding pad for SRE 4350 TurboTec (as spare) 	624738000*
	
Sanding plate perforated 114 x 102 mm <ul style="list-style-type: none"> Perforated, hook and loop sanding pad FSR 200 Intec (as spare) 	625657000*

Hook and loop sanding sheets

Sanding sheets 230 x 280 mm



Dimensions mm	Grit	Sales unit / packing unit	Order no.
Sanding sheets 230 x 280 mm for lacquers, fillers, plastics, professional series			
			
NEW			
230 x 280	P 80	1/50	628600000
230 x 280	P 120	1/50	628602000
230 x 280	P 180	1/50	628603000
230 x 280	P 240	1/50	628604000
230 x 280	P 320	1/50	628605000
230 x 280	P 400	1/50	628606000
230 x 280	P 600	1/50	628607000
230 x 280	P 1200	1/50	628608000
Sanding sheets 230 x 280 mm for wood and paint, professional series			
			
NEW			
230 x 280	P 40	1/50	628609000
230 x 280	P 60	1/50	628610000
230 x 280	P 80	1/50	628611000
230 x 280	P 100	1/50	628612000
230 x 280	P 120	1/50	628613000
230 x 280	P 180	1/50	628615000
230 x 280	P 240	1/50	628617000
Sanding sheets 230 x 280 mm for metal, NF metals, professional series			
			
NEW			
230 x 280	P 40	1/50	628620000
230 x 280	P 60	1/50	628621000
230 x 280	P 80	1/50	628622000
230 x 280	P 100	1/50	628623000
230 x 280	P 120	1/50	628624000
230 x 280	P 180	1/50	628626000
230 x 280	P 220	1/50	628627000
230 x 280	P 240	1/50	628628000
230 x 280	P 320	1/50	628630000

*Self-service packaging

Accessories for multi sanders

Hook and loop sanding sheets for wood, »professional« series

- High-quality sanding paper with semi-open coarseness
- For all woods, solid wood, veneers, plastics, acrylics, lacquers, putty, filling compounds
- For deburring, cleaning of plywood, veneers, solid woods, lacquers and deburring furniture veneer etc.

Dimensions mm	Grit	Sales unit	Order no.
 <p>Hook and loop sanding sheets 100 x 150 mm, 9 holes</p>			
			NEW
100 x 150	P 40	10	635205000
100 x 150	P 60	10	635206000
100 x 150	P 80	10	635207000
100 x 150	P 100	10	635208000
100 x 150	P 120	10	635209000
100 x 150	P 180	10	635210000
100 x 150	P 240	10	635211000
 <p>Hook and loop sanding sheets 100 x 150 mm, 11 holes, 2 pieces</p>			
100 x 150	P 40	10	625603000*
100 x 150	P 60	10	625604000*
100 x 150	P 80	10	625605000*
100 x 150	P 100	10	625606000*
100 x 150	P 120	10	625607000*
100 x 150	P 180	10	625608000*
100 x 150	P 240	10	625609000*
Assortment (2 each of P 60, P 80, P 120, P 180 and P 240)			625610000*

Hook and loop sanding sheets for paints and lacquers, »professional« series



- High-quality sanding paper with semi-open coarseness and high removal of material
- Suitable for working with paints and lacquers of all types and filler compounds
- For deburring, cleaning veneers, solid woods, plywood, lacquers and deburring furniture veneer etc.

Dimensions mm	Grit	Sales unit	Order no.
 <p>Hook and loop sanding sheets 100 x 150 mm, 9 holes</p>			
			NEW
100 x 150	P 40	10	635212000
100 x 150	P 60	10	635213000
100 x 150	P 80	10	635214000
100 x 150	P 120	10	635216000
100 x 150	P 180	10	635217000
100 x 150	P 240	10	635218000

*Self-service packaging

Dimensions mm	Grit	Sales unit	Order no.
 <p>Hook and loop sanding sheets 100 x 150 mm, 11 holes, 2 pieces</p>			
100 x 150	P 40	10	625611000*
100 x 150	P 60	10	625612000*
100 x 150	P 80	10	625613000*
100 x 150	P 100	10	625614000*
100 x 150	P 120	10	625615000*
100 x 150	P 180	10	625616000*
100 x 150	P 240	10	625617000*
Assortment (2 each of P 40, P 80, P 120, P 180 and P 240)			625618000*

Sanding pads with hook and loop

Order no.	
635219000*	
 <p>Sanding pad, perforated</p> <ul style="list-style-type: none"> ■ Sanding pad for PowerMaxx SMA 12 BL (as spare) ■ Particularly effective extraction in combination with the textile dust bag (631369000) compact ■ Quick change system of the sanding pad <p>Dimensions: 100 x 150 mm</p>	
625600000*	
 <p>Sanding pad, perforated</p> <p>Sanding pad for FMS 200 Intec (as spare)</p> <p>Dimensions: 147 x 100 mm</p>	



Extraction Accessories for Random Orbital Sanders/Orbital Sanders/Multi Sanders



Dust bag holders



Order no.	
631289000*	
 <p>Dust bag holder, complete</p> <p>As spare, with 1 dust bag</p> <p>suitable for orbital sanders / multi sanders: Sr 356, Sr E 357, Sr 358, Sr E 359</p> <p>suitable for random orbital sanders: SX E 425, SX E 425 XL, SX E 450 Duo</p>	

Dust bags (paper)

Order no.	
631286000*	
 <p>Dust bag</p> <p>Without dust bag holder 631385000, as spare, pack of 5</p> <p>suitable for orbital sanders / multi sanders: Sr 226, Sr E 227, Sr 216, Sr E 217, Sr 326, Sr E 327, Sr 328, Sr E 329</p> <p>suitable for random orbital sanders: SX E 125</p>	
631288000*	
 <p>Dust bag</p> <p>Without dust bag holder 631289000, as spare, pack of 5</p> <p>suitable for orbital sanders / multi sanders: Sr 356, Sr E 357, Sr 358, Sr E 359</p> <p>suitable for random orbital sanders: SX E 425, SX E 425 XL, SX E 450 Duo</p>	

Dust bags		Order no.
	Textile dust bag With connector, for the Metabo orbital sanders with dust extraction. Can be used in place of the dust bag holder supplied suitable for orbital sanders / multi sanders: Sr 226, Sr E 227, Sr 216, Sr E 217, Sr 326, Sr E 327, Sr 328, Sr E 329 suitable for random orbital sanders: SX E 125	631235000*
	Textile dust bags Easy to empty textile dust bag for working without extraction facilities suitable for orbital sanders / multi sanders: SR 2185, SRE 3185 suitable for random orbital sanders: SXE 3125, SXE 3150	631287000*
	Textile dust bag compact Wear-resistant and very long service life thanks to high-grade polyester fleece Easy emptying thanks to zipper and spring system (tapping out) Suitable for power tools with an extraction connection with outer diameter of 28 mm Suitable for power tools with an extraction connection with inner diameter of 35 mm	631369000*

Dust collector cartridges		Order no.
	Dust collection cartridge With pleated filter 631980000, can be cleaned several times suitable for random orbital sanders: SXE 425 TurboTec, SXE 450 TurboTec	625599000*
	Dust collection cartridge Dust collector cartridge including dust filter 625602000 suitable for orbital sanders / multi sanders: FMS 200 Intec, FSR 200 Intec suitable for random orbital sanders: FSX 200 Intec	625601000*
	Dust collection cartridge With pleated filter 631980000, can be cleaned several times Included in scope of delivery for SR 10-23 Intec / SXE 325 Intec suitable for orbital sanders / multi sanders: SR 10-23, SR 10-23 Intec, SR 20-23, SR 180 suitable for random orbital sanders: SXE 325 Intec	631981000

Pleated filter		Order no.
	Pleated filter Pleated filter, polyester, for dust collector cartridge 625601000 suitable for orbital sanders / multi sanders: FMS 200 Intec, FSR 200 Intec suitable for random orbital sanders: FSX 200 Intec	625602000*
	Pleated filter Polyester (as spare), for the dust collector cartridges 631981000, 625599000, 625598000 suitable for orbital sanders / multi sanders: SR 10-23, SR 10-23 Intec, SR 20-23, SRE 4350 TurboTec, SRE 4351 TurboTec, SR 180 suitable for random orbital sanders: SXE 425 TurboTec, SXE 450 TurboTec	631980000*

Connector		Order no.
	Connector ■ Connector Ø 35 mm for connection to a normal vacuum cleaner suitable for orbital sanders / multi sanders: FMS 200 Intec, FSR 200 Intec suitable for random orbital sanders: FSX 200 Intec	626996000*

*Self-service packaging

Hook and loop sanding sheets for triangular base-plate sanders and multi-tool

Hook and loop sanding sheets for wood and metal, »professional« series

- High-quality sanding paper with semi-open coarseness and high removal of material for a homogenous finish
- For veneers, solid wood, polyester, steel and stainless steel sheets, non-ferrous metals, alloys
- For sanding veneered cabinet fronts and sides, sanding furniture covered with veneers with hot-melt type adhesive edges, decorative sanding of stainless steel sheets, sanding-based repair work, and deburring cut sheet metal

Dimensions mm	Grit	Sales unit	Order no.
			
Hook and loop sanding sheets 93 x 93 mm, 6 holes			
93 x 93	P 40	5	624940000*
93 x 93	P 60	5	624941000*
93 x 93	P 80	5	624942000*
93 x 93	P 100	5	624943000*
93 x 93	P 120	5	624944000*
93 x 93	P 180	5	624945000*
93 x 93	P 240	5	624946000*
93 x 93	P 320	5	624947000*
93 x 93	P 40	25	624980000
93 x 93	P 60	25	624981000
93 x 93	P 80	25	624982000
93 x 93	P 100	25	624983000
93 x 93	P 120	25	624984000
93 x 93	P 180	25	624985000
93 x 93	P 240	25	624986000
93 x 93	P 320	25	624987000
Assortment (10 x P 60, 10 x P 80, 5 x P 120)			624988000

Hook and loop sanding sheets for paints and lacquers, »professional« series

- High-quality sanding paper with semi-open coarseness and high removal of material
- Suitable for working with paints and lacquers of all types and filler compounds
- For deburring, cleaning veneers, solid woods, plywood, and lacquers, deburring furniture veneer

Dimensions mm	Grit	Sales unit	Order no.
			
Hook and loop sanding sheets 93 x 93 mm, 6 holes			
93 x 93	P 40	25	625681000
93 x 93	P 60	25	625682000
93 x 93	P 80	25	625683000
93 x 93	P 120	25	625685000
93 x 93	P 180	25	625686000
93 x 93	P 240	25	625687000
93 x 93	P 320	25	625688000

Hook and loop abrasive nylon web, corundum abrasive





- Used for structuring wood (applying a rustic appearance), for removing rust from metal and for sanding paints (tarnishing)

Grit	Order no.
P 100	624958000*
P 280	624959000*

Accessories for triangular base-plate sanders

Perforated hook and loop sanding pads

	Order no.
 <p>Perforated hook and loop sanding pad For the triangular base-plate sanders DS E 170 and DS E 180 (as spare) Dimension from corner to corner: 93 mm</p>	624970000*
 <p>Perforated hook and loop sanding pad For the triangular base-plate sanders DSE 280, DSE 300 and DSE 300 Intec (as spare) Dimension from corner to corner: 90 mm</p>	624992000*



Special lamellar base-plate

	Order no.
 <p>Special lamellar base-plate For triangular base-plate sander DSE 170/ 180/ 280/ 300. Hook and loop at the bottom side. The self-adhesive hook and loop liner supplied can be fitted to the top of this base-plate so that hook and loop sanding sheets can be fitted for top and bottom sanding of louvres.</p>	624971000*

Self-adhesive hook and loop liner

	Order no.
 <p>Self-adhesive liner Self-adhesive hook and loop liner (as spare for special lamellar base-plate 624971000)</p>	624972000*



Accessories for dust extraction

	Order no.
 <p>10 Dust filters For the dust collector cartridge 624993000 of the DSE 300 Intec and the DSE 280 Intec</p>	624995000*
 <p>Extraction nozzles For external dust extraction for the DSE 300/ DSE 300 Intec and the DSE 280 Intec</p>	624994000*
 <p>Adapter 30/35 mm For connecting the suction hose with connector Ø 35 mm to an extraction nozzle Ø 30 mm</p>	624996000

Accessories for belt sanders

Sanding belts for wood and metal, »professional« series

- High-quality sanding paper with high coarseness, high removal of material
- For veneers, solid wood, polyester, steel and stainless steel sheets, non-ferrous metals, alloys
- For sanding veneered cabinet fronts and sides, sanding furniture covered with liners with hot-melt type adhesive edges, sanding-based repair work, and deburring cut sheet metal etc.



	Dimensions mm	Grit	Sales unit	Order no.
Sanding belts 75 x 533 mm				
	75 x 533	P 40	3	631001000*
	75 x 533	P 60	3	631002000*
	75 x 533	P 80	3	631003000*
	75 x 533	P 100	3	631004000*
	75 x 533	P 120	3	631005000*
	75 x 533	P 180	3	631006000*
	75 x 533	P 240	3	631007000*
	75 x 533	P 320	3	631008000*
	75 x 533	P 40	10	625929000*
	75 x 533	P 60	10	625930000*
	75 x 533	P 80	10	625931000*
	75 x 533	P 100	10	625932000*
	75 x 533	P 120	10	625933000*
Sanding belts 75 x 575 mm				
	75 x 575	P 40	3	625940000*
	75 x 575	P 60	3	625941000*
	75 x 575	P 80	3	625942000*
	75 x 575	P 120	3	625944000*
Sanding belts 180 x 1550 mm				
	180 x 1.550	P 60	2	631190000
	180 x 1.550	P 80	2	631191000
	180 x 1.550	P 100	2	631192000
	180 x 1.550	P 150	2	631193000
	180 x 1.550	P 80	2	631195000 ¹

¹with fabric base

Assortment of sanding belts for wood and metal, »professional« series

	Order no.
 <p>3 Sanding belts Assortment (each 1 x P60, P80, P100) Dimensions: 75 x 533 mm</p>	625928000*

Bases for sanding belts

	Order no.
 <p>Bases for sanding belts Made from graphite-coated fabric; suitable for Ba E 1075 Sales unit: 2</p>	631034000*
 <p>Bases for sanding belts Made from graphite-coated fabric; granular version; Dimensions 84 x 160 mm; suitable for BAE 75 Sales unit: 2</p>	631114000*

*Self-service packaging

Long-neck sanders: which grinding media for which application?

	Hook and loop sanding sheets, »professional«, multi-perforation	Hook and loop sanding sheets, »professional«, stearate coated	Abrasive Mesh	Hook and loop sanding sheets, »professional«, SiC	Nylon web	Sanding pad, soft, Ø 225 mm order no. 626662000	Sanding pad, hard, Ø 225 mm order no. 626661000
Area of application							
Sanding of compound seams	■	■	■			■	■
	P40 - P120	P40 - P120	P80 - P120			for soft filler compound	for hard filler compound
Sand full-surface filled areas	■	□	□			■	■
	P80 - P180	P80 - P180	P80 - P120			for soft filler compound	for hard filler compound
Surface fine polish (high-quality reworking)	■	■				■	■
	P180 - P220	P180 - P220					
Removal of wall paper residue	■	■	□			■	■
	P100 - P180	P100 - P180	P100				
Spot sanding / sanding of old paint layers	□	■	■				■
	P40 - P100	P40 - P100	P80 - P120				
Spot sanding of base coat	■	■	■				■
	P80 - P100	P80 - P100	P80				
Spot sanding of insulation boards (e.g. Styrofoam)/ joints				■			■
				P16			
Spot sanding of surfaces with wallpaper (woodchip)				■			■
				P16			
Spot sanding of old paint layers prior to applying a new layer					■	■	■
					A100 - A180		

□ Well suited ■ Highly suitable

Accessories for long-neck grinders

Hook and loop sanding sheets, »professional« series

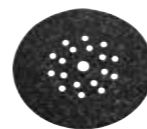

- High-quality silicone carbide sanding paper for spot sanding and roughing of surfaces such as styrofoam boards for thermal insulation, as well as for woodchip for faster absorption of liquids when removing wallpaper.

Diameter mm	Grit	Sales unit	Order no.
225	P 16	10	626640000*

Hook and loop sanding sheets for filler, paints and lacquers, »professional« series



- High-quality sanding paper with very open coarseness and high removal of material. From grit 150 stearate-coated
- Especially for processing fillings in drywall construction, and for paint, varnish.

Diameter mm	Grit	Sales unit	Order no.
225	P 40	25	626641000*
225	P 60	25	626642000*
225	P 80	25	626643000*
225	P 100	25	626644000*
225	P 120	25	626645000*
225	P 150	25	626646000*
225	P 180	25	626647000*
225	P 220	25	626648000*

Hook and loop sanding sheets with multi-perforation for filler, paints and lacquers, »professional« series



- High-quality sanding paper, full-surface perforated, with high removal of material
- Particularly effective extraction thanks to the full-surface perforation and special hook and loop layer for low-dust working
- Minimized clogging of the grinding media, providing greater material removal and longer tool life.
- Especially for processing fillings in drywall construction, and for paint, varnish.

Diameter mm	Grit	Sales unit	Order no.
225	P 40	25	626649000
225	P 60	25	626650000
225	P 80	25	626651000
225	P 100	25	626652000
225	P 120	25	626653000
225	P 150	25	626654000
225	P 180	25	626655000
225	P 220	25	626656000

Nylon webs



- Suitable for spot-grinding, roughening, degreasing and matting of surfaces
- Particularly suited for spot sanding of glazed wooden surfaces e.g. glazed slot and spring board connections.

Diameter mm	Grit	Sales unit	Order no.
225	A 100	10	626659000
225	A 280	10	626660000

Abrasive mesh for long-neck sanders



- Especially for processing fillers in drywall construction
- Suitable for pliable areas that are not yet completely set.

Diameter mm	Grit	Sales unit	Order no.
225	P 80	25	626657000*
225	P 100	25	626658000*
225	P 120	25	626666000*

Further accessories for long-neck sanders



- Sanding pad hard**
- Particularly suited for high material removal.
- Diameter: 225 mm
Hardness: hard
Version: perforated (18 holes)

Order no.
626661000*



- Sanding pad**
- Very soft, flexible sanding pad, particularly suited for curved, uneven surfaces
 - Standard version of the long-neck grinder
- Diameter: 225 mm
Hardness: very soft
Version: perforated (18 holes)

Order no.
626662000*



- Replacement brush rim**
- Replacement brush rim long-neck sander

Order no.
626663000*



- Flexible shaft**
- Replacement shaft as contained in the scope of delivery
 - Simple, quick and tool-free exchangeable shaft easily changed on site if needed

Order no.
626664000*



- Extension**
- Provides a machine length of 2.1 m
 - Installation without tools
 - Easy and safe storage in the machine case
 - Length: 550 mm

Order no.
626665000*

Accessories for routers

Collets for OFE 738, Of E 1229 Signal, FME 737



Collet bore	Version	Order no.
3 mm	hexagon	631947000*
6 mm	hexagon	631945000*
6 mm	double flat	630820000
8 mm	double flat	630833000
8 mm	hexagon	631946000*
1/8" (3,18 mm)	hexagon	631948000*
1/4" (6,35 mm)	double flat	630821000
1/4" (6,35 mm)	hexagon	631949000

For Of E 1812



Collet bore	Version	Order no.
8 mm	hexagon	631567000

Accessories for routers OFE 738 and Of E 1229 Signal



- Parallel guide**
- Parallel guide/rip fence with fine adjustment for routers OFE 738 and Of E 1229 Signal (supplied as standard)

Order no.
631507000



- Circle-cutting centering pin**
- For using in the parallel guide/rip fence of routers OFE 738 and Of E 1229 Signal, for milling circular grooves and similar work

Order no.
631504000



- Intermediate plate**
- For fixing on the base plate of routers OFE 738 and Of E 1229 Signal, especially suited for trimming edging strips flush with edges

Order no.
631503000



- Circle-cutting guide**
- For cutting out round openings, moulding/routing circular grooves, rounding off corners, etc., maximum circle diameter 350 mm

Order no.
631505000

Template followers





- For engraving text etc. using a template clamped on to the workpiece

Diameter mm	Order no.
9	630105000
11	630106000
17	630118000
24	630119000
27	630120000
30	630121000

*Self-service packaging

*Self-service packaging

Guide rail		Order no.
	<p>Guide rail</p> <ul style="list-style-type: none"> ■ Guide rail made of sturdy, anodised aluminium extrusion ■ Anti-slip backing provides safe and reliable support and protects the work piece surface against scratches ■ Guide rule, adjustable to eliminate play <p>suitable for: Metabo jigsaws, circular saws and router models OFE 738 and Of E 1229 Signal (when using the appropriate accessories; KS 55 FS, KSE 55 Vario Plus, KS 66 Plus, KSE 68 Plus can be used directly); also suitable for the CED 125 Plus dust extraction shroud in connection with an angle grinder Overall length: 1,500 mm</p>	631213000

Router guide		Order no.
	<p>Router guide</p> <ul style="list-style-type: none"> ■ Enables moulding/routing with routers OFE 738 and Of E 1229 Signal along the precision guide rails <p>For these tasks the 631503000 intermediate plate must be fitted to the router's base plate</p>	631248000

Other accessories for the router and grinder motor

Moulding/routing attachment		Order no.
	<p>Moulding/routing attachment</p> <ul style="list-style-type: none"> ■ With this moulding/routing attachment, router and grinder motor FME 737 can be converted into a router 	631501000

Flexible shafts		Order no.
	<p>Flexible shaft 27609</p> <ul style="list-style-type: none"> ■ Suitable for speeds of 20,000 to 30,000 rpm ■ Bearing-mounted at both ends ■ For router bits, mounted points, flap wheels etc. with 6 mm shaft diameter. Interchangeable collet for accessories with 3 mm shaft diameter available as accessory (630715000) ■ 6 mm driving shaft for fixing the flexible shaft in the collet bore of the drive machine. If the collet bore of the drive machine has a different dimension than 6 mm, the collet of the drive machine must be changed. 6 mm collet available as accessory (631945000) <p>suitable for routers: FME 737 suitable for die grinders: G 400, GE 710 Compact, GE 710 Plus, GA 18 LTX Length: 1.3 m Driving shaft: 6 mm Collet bore: 6 mm Weight: 0.8 kg</p>	627609000*

		Order no.
	<p>Flexible shaft 30980</p> <ul style="list-style-type: none"> ■ Suitable for speeds of 7,500 to 30,000 rpm ■ Bearing-mounted at both ends ■ For router bits, mounted points, flap wheels etc. with 8 mm shaft diameter. Interchangeable collet for accessories with 6 mm shaft diameter (630977000) and 3 mm shaft diameter (630976000) available as accessory ■ 8 mm driving shaft for fixing the flexible shaft in the collet bore of the drive machine. If the collet bore of the drive machine has a different dimension than 8 mm, the collet of the drive machine must be changed. 6 mm collet available as accessory (631945000) <p>suitable for routers: FME 737 suitable for die grinders: G 400, GE 710 Compact, GE 710 Plus, GE 950 G Plus, GA 18 LTX Length: 1.3 m Driving shaft: 8 mm Collet bore: 8 mm Weight: 0.8 kg</p>	630980000*

Collets for flexible shafts		Order no.
	<p>Collets for flexible shaft 630980000</p> <ul style="list-style-type: none"> ■ To attach the carbide router bits, mounted points etc. to the flexible shaft 	
	3 mm	630976000
	6 mm	630977000
	8 mm	630979000

	<p>Collets for flexible shaft 627609000</p> <ul style="list-style-type: none"> ■ For fixing the carbide router bits, mounted points, etc. on the flexible shaft 	
	6 mm	630714000
	3 mm	630715000

Clamping stand		Order no.
	<p>Clamping stand</p> <ul style="list-style-type: none"> ■ For safe clamping of drills and impact drills as well as die grinders and the motor of the router when working with flexible shafts. Aperture Ø 43 mm. The clamp (627107000) serves for the secure fixing 	627354000*

Clamp		Order no.
	<p>Clamp</p> <ul style="list-style-type: none"> ■ For the secure fixing on a work table 	627107000*

*Self-service packaging

Accessories for paint remover

Reversible carbide blades



- High-quality carbide for long tool life and uniform grinding result

Sales unit	Order no.
4	631720000*
10	631660000*

Suction hose



Suction hose Ø 27 mm

- Flexible and easy extension: extraction hose can be connected to a second one without additional connector
 - Rubber connector (internal Ø 30 mm, outside Ø 35 mm)
- Hose length: 3.5 m Anti-static: no
 Hose-Ø, internal: 27 mm Conducts electricity: no
 Hose-Ø, external: 33 mm Bayonet connection: yes
 Connection-Ø, external: 27 mm Rotating adapter: machine side

Order no.
631938000

Planer accessory

Reversible carbide planer blade



Reversible carbide planer blade

- Consisting of 2 reversible carbide planer blades
- Suitable for: HO 18 LTX 20-82, HO 26-82, HO 0882

Order no.
630282000*



Reversible carbide planer blade

- Consisting of 10 reversible carbide planer blades
- Suitable for: HO 18 LTX 20-82, HO 26-82, HO 0882

Order no.
630272000

Additional accessories for planers



Stand for planer

- For stationary use of the planer (as surface planer)
- Clamp 627107000 for fastening the stand securely on a workbench
- Suitable for: HO 0882

Order no.
631599000*



Clamp

- For the secure fixing on a work table

Order no.
627107000*

Which connection option for which handheld power tool?

	Mains-powered vacuum cleaner			Cordless vacuum cleaner			
	ASA 32 L ASA 25 L PC1) ASA 30 L PC Innox1) ASR 25 L SC ASR 25 M SC	ASR 50 L SC ASR 50 M SC ASR 35 L ACP ASR 35 M ACP ASR 35 H ACP		AS 18 L PC AS 18 L PC Compact AS 18 HEPA PC Compact ASR 36-18 BL 25 M SC			
Suction hose diameter	Ø 27 mm		Ø 32 mm	Ø 35 mm			
Hose length	3,5 m	3,5 m	3,5 m	2,5 m	3,2 m	4,0 m	4,0 m
Order no.	631938000	631939000	631337000	631752000	631362000	631370000	630344000
	antistatic			antistatic 630177000 conducts electricity			
	without adapter			with 624996000			
Adapters and connectors							
Long-neck sanders							
LSV 5-225 Comfort, LSV 5-225	■						
Cordless circular saws/plunge cut circular saw							
KS 18 LTX 57, KS 18 LTX 66 BL, KT 18 LTX 66 BL	■						
Circular saws							
KSE 55 Vario Plus, KS 55, KS 55 FS, KS 85 FS / KS 66 FS	■/□						
Jigsaws/cordless jigsaw							
STA 18 LTX 100, STAB 18 LTX 100 STE 140 Plus, STEB 140 Plus STA 18 LTX 140, STEB 65 Quick, STE 100 Quick STEB 70 Quick, STEB 80 Quick	■						
Sanding tools/cordless sanding tools							
DSE 280 Intec, DSE 300 Intec	with adapter 624994000						
FMS 200 Intec, FSR 200 Intec, FSX 200 Intec	■						
SRE 3185, SR 2185, SXE 3125, SXE 3150	■						
SX E 400	■						
SXE 425 TurboTec, SXE 450 TurboTec, SXA 18 LTX 125 BL	■						
SXE 150-2.5 BL, SXE 150-5.0 BL	■						
SRE 4350 TurboTec, SRE 4351 TurboTec	■						
Multi-tools							
MT 18 LTX, MT 18 LTX BL QSL, MT 400 Quick	■						
Belt sanders							
BAE 75	■						
Diamond cutting systems and extraction shrouds							
T 13 - 125 CED, TEPB 19-180 RT CED, TE 24-230 MVT CED	■/□						
CED 125, CED 125 Plus, CED 125 Clip	■/□						
Guard Ø 180 mm, Ø 230 mm	■/□						
Routers and planers							
HO 18 LTX 20-82, HO 26-82, LF 724 S, OFE 738, OFE 1229 Signal	■/□						
Wall chasers							
MFE 65							
MFE 40	■						
Renovation machines and extraction shroud							
RSEV 17-125, RESV 19-125 RT, RFEV 19-125 RT, Absaughaube GED 125	■/□						

1) only compatible with hose 631337000 ■ Connection possible without adapter
 □ Connection possible via an optional coupling bush (order no. 630796000)













Extraction possibility when drilling

- For all drills, combination and multi hammers as well as drills and impact drills
- Vacuum cleaner adapter for extracting the drill dust directly from the drilled hole
- Auto-suction on almost all surfaces

	DDE 14 For drill bits from Ø 4-14 mm Connection Ø 37 mm external / Ø 32 mm internal	Order no. 630829000		DDE 72 For drill bits and core bits from Ø 6-72 mm Connection Ø 37 mm external / Ø 32 mm internal	Order no. 631343000
--	--	------------------------	--	--	------------------------







*Self-service packaging





Which connection option for which wood processing tool?

	Mains-powered vacuum cleaner						Cordless vacuum cleaner		Chip and dust extraction units		
	ASA 32 L ASA 25 L PC ¹⁾ ASA 30 L PC Inox ¹⁾ ASA 25 L SC		ASR 50 L SC ASR 50 M SC ASR 35 L, M, H ACP				AS 18 L PC AS 18 L PC Compact AS 18 HEPA PC Compact ASR 36-18 BL 25 M SC				
Diameter	Ø 27 mm		Ø 32 mm		Ø 35 mm		Ø 58 mm		Ø 100 mm		
Length	3,5 m	3,5 m	3,5 m	2,5 m	3,2 m	4,0 m	3 m		2,5 m ²⁾	5 m	10 m
Order no.	631938000	631939000	631337000	631752000	631362000	631370000	630312000		7854112915	7854115035	
											
Adapters and connectors	without adapter		with suction adapter 0910059955	with adapter 630316000	with suction adapter 0910031260	without adapter		with suction adapter Multi 0910058010	with suction adapter 0910031260	with suction adapter Multi 0910058010	with universal adapter 0913031288
Mitre saws	KS 18 LTX 216 KGS 18 LTX 216 KS 216 M Lasercut KGS 216 M KGSV 216 M KGS 254 M KGS 305 M KS 305 M		KGSV 72 Xact KGSV 72 Xact SYM		KGS 254 Plus KGS 254 I Plus KGS 315 Plus		KGT 305 M				
Table saws	TS 36-18 LTX BL 254 TS 216 TS 254 TS 254 M		TKHS 315 C TKHS 315 M		Planer thicknessers			Band saws			
	HC 260 C DH 330		BAS 261 Precision BAS 318 Precision								

■ Connection possible without adapter
□ Connection possibility via optionally available coupling bush (order no. 630796000)
¹⁾ only compatible with hose 631337000
²⁾ only available in the scope of delivery, available as spare part





Suction hoses

	Order no.
	631938000
<p>Suction hose Ø 27 mm</p> <ul style="list-style-type: none"> Flexible and easy extension: extraction hose can be connected to a second one without additional connector Rubber connector (internal Ø 30 mm, outside Ø 35 mm) <p>Hose length: 3.5 m Anti-static: no Hose-Ø, internal: 27 mm Conducts electricity: no Hose-Ø, external: 33 mm Bayonet connection: yes Connection-Ø, external: 27 mm Rotating adapter: machine side</p>	
	631939000
<p>Suction hose Ø 27 mm</p> <ul style="list-style-type: none"> Flexible and easy extension: extraction hose can be connected to a second one without additional connector Rubber connector (internal Ø 30 mm, outside Ø 35 mm) <p>Hose length: 3.5 m Anti-static: yes Hose-Ø, internal: 27 mm Conducts electricity: no Hose-Ø, external: 33 mm Bayonet connection: yes Connection-Ø, external: 27 mm Rotating adapter: no</p>	
	631337000
<p>Suction hose Ø 32 mm</p> <ul style="list-style-type: none"> With coupling bush with shunt air opening Standard equipment for ASA 25 L PC and ASA 30 L PC Inox <p>Hose length: 3.5 m Anti-static: no Hose-Ø, internal: 32 mm Conducts electricity: no Hose-Ø, external: 40 mm Bayonet connection: no Connection-Ø, external: 27 mm Rotating adapter: on both sides</p>	
	630176000
<p>Stretch suction hose Ø 32mm</p> <ul style="list-style-type: none"> Standard equipment for AS 18 L PC aspirator, suitable for all standard vacuum cleaners from the competition Stretch suction hose for comfortable handling and maximum freedom of movement when vacuuming Stretch suction hose with a length of 0.7 to 3.5 m <p>Hose length: 0.7 - 3.5 m Anti-static: no Hose-Ø, internal: 32 mm Conducts electricity: no Hose-Ø, external: 40 mm Bayonet connection: no Connection-Ø, external: 27 mm Rotating adapter: on both sides</p>	
	631751000
<p>Suction hose Ø 35 mm</p> <ul style="list-style-type: none"> With swivel joint and bayonet connector Standard equipment for AS 20 L <p>Hose Length: 1.75 m Anti-static: no Hose-Ø, internal: 38 mm Conducts electricity: no Hose-Ø, external: 45 mm Bayonet connection: yes Connection-Ø, external: 27 mm Rotating adapter: on both sides</p>	
	631752000
<p>Suction hose Ø 35 mm</p> <ul style="list-style-type: none"> With swivel joint and bayonet connector <p>Hose Length: 2.5 m Anti-static: no Hose-Ø, internal: 38 mm Conducts electricity: no Hose-Ø, external: 45 mm Bayonet connection: yes Connection-Ø, external: 27 mm Rotating adapter: on both sides</p>	
	631362000
<p>Suction hose Ø 35 mm</p> <ul style="list-style-type: none"> Flexible and easy extension: extraction hose can be connected to a second one without additional connector With swivel joint Standard equipment for ASA 32 L, ASR 50 L SC, ASR 25 L SC <p>Hose length: 3.5 m Anti-static: no Hose-Ø, internal: 38 mm Conducts electricity: no Hose-Ø, external: 45 mm Bayonet connection: no Connection-Ø, external: 27 mm Rotating adapter: on both sides</p>	





	Order no.
 <p>Suction hose for MFE, Ø 35 mm</p> <ul style="list-style-type: none"> When using a second suction hose, the dust extraction device can be placed at a distance of up to 8 m from the work area With bayonet fitting for connection to the extraction nozzle of wall chasers MFE 30, MFX 65 and MFE 65 <p>Hose length: 4 m Anti-static: no Hose-Ø, internal: 33 mm Conducts electricity: no Hose-Ø, external: 40 mm Bayonet connection: yes Connection-Ø, external: 58 mm Rotating adapter: on both sides</p>	630344000
 <p>Suction hose Ø 35 mm</p> <ul style="list-style-type: none"> Flexible and easy extension: extraction hose can be connected to a second one without additional connector Standard equipment for ASA 50 M SC <p>Hose length: 4 m Anti-static: yes Hose-Ø, internal: 38 mm Conducts electricity: no Hose-Ø, external: 45 mm Bayonet connection: yes Connection-Ø, external: 27 mm Rotating adapter: on both sides</p>	631370000
 <p>Suction hose Ø 58 mm</p> <ul style="list-style-type: none"> When using a second suction hose, the dust extraction device can be placed at a distance of up to 6 m from the work area <p>Hose length: 3 m Anti-static: no Hose-Ø, internal: 47 mm Conducts electricity: no Hose-Ø, external: 58 mm Bayonet connection: no Connection-Ø, external: 58 mm</p>	630312000
 <p>Suction hose Ø 35 mm</p> <ul style="list-style-type: none"> Suction hose electroconductive Flexible and easy extension: extraction hose can be connected to a second one without additional connector Standard equipment for ASR 36-18 BL 25 M SC <p>Hose length: 4 m Anti-static: no Hose-Ø, internal: 38 mm Conducts electricity: yes Hose-Ø, external: 45 mm Bayonet connection: yes Connection-Ø, external: 27 mm Rotating adapter: on both sides</p>	630177000

NEW





Adapter

	Order no.
 <p>Handle adapter</p> <ul style="list-style-type: none"> As handle, for attaching between the suction hoses and the suction pipes Standard equipment for ASR 2025, ASR 2050 and SHR 2050 M 	630317000
 <p>Reducing sleeve Ø 58/35 mm</p>	631364000
 <p>Adapter Ø 30/35 mm</p> <ul style="list-style-type: none"> For connecting the suction hose with connector Ø 35 mm to an extraction nozzle Ø 30 mm 	624996000
 <p>Adapter Ø 35/58 mm</p> <ul style="list-style-type: none"> For connecting the suction hoses with connection Ø 35 mm to an extraction nozzle Ø 58 mm. Adapter is part of the dust extraction set 630828000. 	630316000*
 <p>Coupling bush internal Ø 40 mm / external Ø 45 mm</p> <ul style="list-style-type: none"> Particularly suited for coarse dirt, as well as tools with high generation of dust Suitable for power tools with an extraction connection with outer diameter of 40 mm Conducts electricity <p>Material: plastic External-Ø: 45 mm Internal Ø, 40 mm</p>	630796000*



*Self-service packaging

	Order no.
 <p>Coupling bush internal Ø 28 mm / external Ø 35 mm</p> <ul style="list-style-type: none"> Universal connection bush for most hand-held power tools. Standard connection bush of the Metabo suction hoses. Conducts electricity; with non-slip internal corrugation Suitable for power tools with an extraction connection with inner diameter of 35 mm Suitable for power tools with an extraction connection with outer diameter of 28 mm <p>Material: plastic External-Ø: 35 mm Internal Ø: 28 mm</p>	630798000*
 <p>Bayonet connector</p> <ul style="list-style-type: none"> Can be connected to Metabo tools with bayonet closure Bayonet connector for connection to all Ø 35mm Metabo suction hoses (remove connection sleeve from the suction hose beforehand) Suitable for: SXE 450 Turbotec; SXE 425 TURBOTEC; Of E 1229 Signal; KSE 55 Vario Plus; KS 66 Plus; KS 66; KSE 55 Vario Plus 	630898000*
 <p>Connecting sleeve Ø 58 mm</p> <ul style="list-style-type: none"> For joining two suction hoses with connector Ø 58 mm 	631365000
 <p>Y-piece</p> <p>With Ø 58 mm connector and two Ø 58 mm openings for use in the Metabo all-purpose vacuum cleaners and the special purpose vacuum cleaner</p>	630897000*









Suction tubes

	Diameter mm	Length m	Material	Sales unit	Order no.
 <p>NEW</p>	35	0,3	Plastic	1 Set	630168000*
	35	0,4	Plastic	2	630314000
	58	0,4	Plastic	2	630867000
	35	0,4	Chrome	2	631363000



















Nozzles

	Order no.
 <p>Suction nozzle</p> <ul style="list-style-type: none"> Ideal for use during installation after e.g. small drilling applications Standard equipment for ASA 1202 and AS 18 L PC <p>Width: 120 mm Connection-Ø, internal: 35 mm</p>	630320000*
 <p>Universal nozzle</p> <ul style="list-style-type: none"> The universal vacuum cleaner nozzle meets high demands Large 2K castor at the back No matter if carpet or hard floor, it glides particularly quietly and provides first-rate suction performance <p>Reversible Width: 300 mm Connection-Ø, internal: 35 mm</p>	630322000
 <p>Floor nozzle</p> <ul style="list-style-type: none"> Plastic floor nozzle with parking position, with bristles (not replaceable) and rollers Design according to BG Bau specifications, dimensions of suction opening: 28x70 mm <p>Width: 300 mm Connection-Ø, internal: 35 mm</p>	630169000*

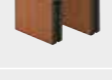
*Self-service packaging

	Order no.
 <p>Floor nozzle</p> <ul style="list-style-type: none"> ■ Universal robust all-purpose nozzle - also ideal as addition to the standard nozzle ■ Multifunctional - also suited for wet application to absorb liquids ■ With brush head and rubber head <p>Width: 370 mm Connection-Ø, internal: 35 mm</p>	630329000
 <p>Floor nozzle</p> <ul style="list-style-type: none"> ■ The all-purpose brush for dry use ■ Adjustable castors to adjust the ground clearance ■ Very robust thanks to aluminium die-cast housing, metal design <p>Width: 450 mm Connection-Ø, internal: 35 mm</p>	631940000
 <p>Floor nozzle</p> <ul style="list-style-type: none"> ■ Universal robust all-purpose nozzle - also ideal as addition to the standard nozzle ■ Easy care, thanks to generous internal dimensions ■ Multifunctional - also suited for wet application to absorb liquids ■ Excellent handling, thanks to low weight for low-fatigue working <p>Width: 360 mm Connection-Ø, internal: 58 mm</p>	630868000
 <p>Set of floor nozzles</p> <ul style="list-style-type: none"> ■ Set made up of: Nozzle body, floor insert and insert for wet vacuuming <p>Width: 370 mm Connection-Ø, internal: 35 mm</p>	630321000
 <p>Multi-purpose nozzle</p> <ul style="list-style-type: none"> ■ With 3 inserts for vacuuming carpets, flat surfaces and for vacuuming liquids <p>Width: 270 mm Connection-Ø, internal: 35 mm</p>	630328000
 <p>Universal brush</p> <ul style="list-style-type: none"> ■ With very soft bristles, which gently loosen the dirt from the surface ■ Suitable for all surfaces, ideal also for use in car cleaning and in the cellar/workshop ■ Easy use thanks to handle <p>Width: 40 mm Length: 120 mm Connection-Ø, internal: 35 mm</p>	630244000*
 <p>Upholstery brush</p> <ul style="list-style-type: none"> ■ Universal use also e.g. as suction brush, furniture brush or instrument panel brush in the car ■ Flexible, the angle of inclination can be changed by rotating the brush head ■ The bristles easily remove the dirt from the surface before it is vacuumed <p>Width: 40 mm Length: 60 mm Connection-Ø, internal: 35 mm</p>	630245000*
 <p>Crevice nozzle</p> <ul style="list-style-type: none"> ■ The crevice nozzle is a universal tool ■ Thanks to its narrow shape it is ideal to clean very small crevices ■ It can be used in connection with wet & dry tools ■ Standard equipment for AS 1200, ASA 1202, ASR 2025, ASR 2050, SHR 2050 M and AS 18 L PC <p>Length: 200 mm Connection-Ø, internal: 35 mm</p>	630323000*
 <p>Rubber nozzle</p> <ul style="list-style-type: none"> ■ Cone for connection to power tools, climbing from 28.0 - 38 mm outside diameter <p>Length: 200 mm Connection-Ø, internal: 35 mm</p>	630324000*

Which filter bags/filter cassettes fit which extraction unit?



Filter bags/filter cassettes		Order no.	AS 18 L PC	AS 18 L PC Compact	AS 18 HEPA PC Compact	AS 20 L AS 1200 ASA 1201	ASA 32 L ASA 1202	ASA 25 L PC ASA 30 L PC Inox	ASR 25 L SC ASR 25 M SC ASR 36-18 BL 25 M SC ASR 2025 ASA 2025	ASR 50 L SC ASR 2050 SHR 2050 M	ASR 50 M SC	ASR 35 L/M ACP	ASR 35 H ACP	
PE disposal bag	 25 l	630275000							■					17
	 30/50 l	630325000									■	■	■	18
	 25/30 l	630298000						■						19
Fleece filter bag	 20 l	631629000				■								20
	 25/35 l	630343000							■			■		21
	 32 l	631665000					■							22
	 45/50 l	630359000								■	■			23
	 25/30 l	630296000						■						24
Pleated filter	 6 l	630164000		■	■									25
	 7,5 l	630173000	■											26
	 Polyester	631753000				■	■							27
	 Polyester	630299000						■						28
	 Polyester HEPA	630175000	■											29
	 Polyester	630172000	■											30
	 Polyester	630212000			■									31
	 Polyester HEPA	630213000			■									32
Filter cassettes	 Cellulose	631933000							■	■	■	■		
	 Polyester	631934000							■	■	■	■		
	 Polyester nano-coated	631894000							■	■	■	■		
	 Polyester H/ HEPA	630326000											■	

*Self-service packaging

Filter bag





PE disposal bag

- 20 times the volume of paper filter bags
- No clogging with fine dust (especially quartz dust)
- Well suited for applications where large amounts of fine dust are generated (e.g. removal of plaster from surfaces, grinding and removal of screed etc.)
- Meet the requirements for M and H class vacuums
- Ideal when using machines for processing concrete and masonry, such as: renovation milling machines, renovation grinder, long-neck sanders, wall chasers etc.
- Clean, simple and fast removal and disposal



	Order no.
 <p>PE disposal bag - 25 l Suitable for: ASR 36-18 BL 25 M SC, ASR 25 M SC Sales unit: 5</p> <p>NEW</p>	630275000*
 <p>PE disposal bag - 25/30 l Suitable for: ASA 25 L PC, ASA 30 L PC Inox Sales unit: 5</p>	630298000*
 <p>PE disposal bag - 35/50 l Suitable for: ASR 35 L AutoClean, ASR 35 M AutoClean, ASR 50 M SC Sales unit: 5</p>	630325000*

Fleece filter bag

- Fleece filter bags are better and easy to open out than paper ones
- Well suited for applications where small amounts of fine dust are generated (e.g. grinding and removal of paint and lacquer coatings or short drilling jobs with small diameters)
- Ideal for use with wood processing machines, such as routers, planer thicknessers, small random orbital sanders and orbital sanders etc.
- Improved mechanical stability

	Order no.
 <p>Fleece filter bags - 6 l Suitable for: AS 18 HEPA PC Compact, AS 18 L PC Compact Sales unit: 5</p> <p>NEW</p>	630164000*
 <p>Fleece filter bag - 7.5 l Suitable for: AS 18 L PC Sales unit: 5</p>	630173000*
 <p>Fleece filter bag - 25/30 l Suitable for: ASA 25 L PC, ASA 30 L PC Inox Sales unit: 5</p>	630296000*
 <p>Fleece filter bags - 25/35 l Suitable for: ASR 35 L AutoClean, ASR 35 M AutoClean, ASR 25 L SC, ASR 25 M SC, ASR 2050, ASA 2025, ASR 35 L ACP, ASR 35 M ACP, ASR 36-18 BL 25 M SC Sales unit: 5</p>	630343000*







*Self-service packaging

	Order no.
 <p>Fleece filter bags - 45/50 l Suitable for: ASR 50 L SC, ASR 50 M SC Sales unit: 5</p>	630359000*
 <p>Fleece filter bag - 20 l Suitable for: AS 1200, ASA 1201, AS 20 L Sales unit: 5</p> <p>NEW</p>	631629000*
 <p>Fleece filter bags - 32 l Suitable for: ASA 1202, ASA 32 L Sales unit: 5</p> <p>NEW</p>	631665000*







Paper filter bag

	Order no.
 <p>Paper filter bag, 27 litres Double-layer Suitable for: ASA 9011 Sales unit: 5</p>	631348000*

Additional accessories for all-purpose vacuum cleaners

	Order no.
 <p>Paper pre-filter ■ Prevents the pleated filter from becoming clogged with dirt and dust Suitable for: ASA 9050, ASR 1250 Sales unit: 5</p>	631345000*
 <p>Polyester pre-filter ■ Prevents the pleated filter from becoming clogged with dirt and dust Suitable for: AS 1200, ASA 1201, ASA 1202, AS 20 L, ASA 32 L Sales unit: 1</p>	631967000*
 <p>Pleated filter ■ Corresponds to dust class L Suitable for: AS 18 L PC Compact Sales unit: 1</p>	630212000*
 <p>Pleated filter ■ HEPA filter with reduction efficiency >99.95% Suitable for: AS 18 HEPA PC Compact Sales unit: 1</p>	630213000*
 <p>Pleated filter ■ Corresponds to dust class L Suitable for: AS 18 L PC Sales unit: 1</p>	630172000*
 <p>Pleated filter ■ HEPA filter with reduction efficiency >99.95% Suitable for: AS 18 L PC Sales unit: 1</p>	630175000*
 <p>Pleated filter ■ Corresponds to dust class M Suitable for: ASA 25 L PC, ASA 30 L PC Inox Sales unit: 1</p>	630299000*

*Self-service packaging

	Order no.
 <p>Pleated filter</p> <ul style="list-style-type: none"> ■ Corresponds to dust class M <p>Suitable for: AS 20 L, AS 1200, ASA 1201, ASA 32 L, ASA 1202 Sales unit: 1</p>	631753000*
 <p>Paper filter cassettes</p> <ul style="list-style-type: none"> ■ Corresponds to dust class M <p>Suitable for: ASA 2025, ASR 2025, ASR 2050, SHR 2050 M, ASR 35 L AutoClean, ASR 35 M AutoClean Sales unit: 2</p>	631933000*
 <p>2 Polyester filter cassettes</p> <ul style="list-style-type: none"> ■ Corresponds to dust class: M ■ Also suitable for absorbing graphite/toner and vacuuming liquids <p>Suitable for: ASA 2025, ASR 2025, ASR 2050, SHR 2050 M, ASR 35 L AutoClean, ASR 35 M AutoClean Sales unit: 2</p>	631934000*
 <p>2 HEPA filter cassettes</p> <ul style="list-style-type: none"> ■ Corresponds to dust class H (HEPA 14) ■ HEPA = high efficiency particular air filter ■ Keeps back 99.995% of fine dusts larger than 0.3 µm <p>Suitable for: ASR 2025, ASR 2050, SHR 2050 M, ASR 35 L AutoClean, ASR 35 M AutoClean Sales unit: 2</p>	630326000*
 <p>2 Filter cassettes, polyester, nano-coated</p> <ul style="list-style-type: none"> ■ Suitable for fibrous fine dusts; e.g. when cutting and grinding Fermacell boards, gypsum plaster and MDF boards ■ Larger pleat distance for better, easier cleaning of the filter ■ Smooth filter material (surface nano-coated); therefore significantly higher volume flow for a longer time ■ Corresponds to dust class M <p>Suitable for: ASR 25 L SC , ASR 50 M SC, ASR 50 L SC, ASR 35 L AutoClean, ASR 35 L ACP, ASR 35 M AutoClean, ASR 35 M ACP Sales unit: 2</p>	631894000*
 <p>Carrying Handle</p> <ul style="list-style-type: none"> ■ Very light and easily mobile as a result ■ Including spring cotter <p>Suitable for: ASR 35 L AutoClean, ASR 35 M AutoClean Sales unit: 1</p>	630311000
 <p>Metadepot</p> <ul style="list-style-type: none"> ■ For practical storage of pipes, cables and accessories. ■ Provides the combination of Metabo all-purpose vacuum cleaners with the MetaLoc system <p>Suitable for: ASR 2025, ASR 2050, SHR 2050 M, ASR 25 L SC , ASR 50 L SC, ASR 50 M SC Sales unit: 1</p>	631937000

Extraction with start/stop automatic mechanism: now also possible for cordless tools



Previously, you had to switch your mains-powered vacuum cleaner separately on and off when using a cordless tool. With immediate effect, this is now taken over by the new start/stop set CordlessControl. **The vacuum cleaner is automatically switched on/off by detecting vibrations.**

Easy to retrofit





For all brands of wet vacuum cleaners

Possible for all standard suction hose diameters

For all brands of cordless tools





CordlessControl

	Order no.
 <p>Start/Stop set CordlessControl</p> <ul style="list-style-type: none"> ■ When starting upshutting down the cordless tool, the connected mains-powered vacuum cleaner starts/stops automatically ■ Compatible with standard cordless, mains-powered tools and vacuum cleaners available on the market ■ Manual starting of the vacuum cleaner is also possible with the remote button at the coupling bush of the hose ■ "Vibration detection" function at the transmitter permits automatic start-up/shut-down of the vacuum cleaner by detecting vibrations ■ If the vibrations are too low, the transmitter can be connected directly to the extracting tool using the multi tape ■ Multi tape to fix the transmitter to all standard hose diameters ■ Start/stop cordless control replaces the function of the integrated power socket for a mains-powered tool <p>Radio frequency: 2402 - 2445 Mhz Mains voltage: 220-240 V Power supply transmitter: CR2032 Signal strength: - 6 dBm Scope of delivery: receiver socket, transmitter, 3x multi tape, battery CR 2032</p>	Typ F: 630231000* Typ E: 630234000* Typ J: 630253000*
 <p>CordlessControl transmitter with 3x multi tape</p> <p>Radio frequency: 2402 - 2445 Mhz Power supply transmitter: CR2032 Signal strength: - 6 dBm Scope of delivery: transmitter, 3x multi tape, battery CR2032</p>	630256000*
 <p>Multi tape</p> <ul style="list-style-type: none"> ■ Replacement multi tape (3x) for Start/Stop Set CordlessControl ■ Scope of delivery: 3x multi tape 	630403000*
 <p>Remote-controlled socket CordlessControl</p> <ul style="list-style-type: none"> ■ Replacement socket for start/stop set CordlessControl <p>Mains voltage: 220-240 V Scope of delivery: 1x remote-controlled socket</p>	Typ F: 630413000* Typ E: 630414000* Typ J: 630406000*

*Self-service packaging

Auto switch-on devices

- Automatic power on/off of the chip and dust extraction unit after the wood processing machine has been switched on or off
- Time-delayed: in this way, even residual dust is extracted

	Order no.
 <p>Auto switch-on device ALV 1 2 Alternating current sockets (230 V) 200 VA - 2300 VA IP 44 340 g Mains voltage: 220-240 V Mains frequency: 50 - 60 Hz Dimensions: 158 x 116 x 60 mm Suitable for: SPA 1000, SPA 1100, SPA 1701 W, SPA 2001 W, SPA 1101, SPA 1702 W, SPA 2002 W, SPA 1200</p>	0913014626
 <p>Auto switch-on device ALV 10 2 Alternating current sockets (230 V) 2 Three-phase sockets (400 V) Mains connection with phase inverter Mains voltage: 220-240 V / 380-400 V 4 Screwing options M5 x 7.2 mm IP 44 Mains voltage: 230/400 V Mains frequency: 50 - 60 Hz Fuse protection: T 16 A Dimensions: 235 x 106 x 155 mm Suitable for: SPA 1000, SPA 1700 D, SPA 2000 D, SPA 1100, SPA 1701 W, SPA 2001 W, SPA 2001 D, SPA 1101, SPA 1702 W, SPA 2002 W, SPA 2002 D, SPA 1200</p>	0913014634

Filter cartridges

- Filters the finest dust particles

	Order no.
 <p>Filter cartridge Filter area 5.2 m² Ø 327 x 857 mm Corresponds to dust class M Suitable for: SPA 1000, SPA 1100, SPA 1101</p>	0913005058
<p>Filter cartridge Filter area 5.2 m² Ø 327 x 857 mm Corresponds to dust class M Suitable for: SPA 1700 D, SPA 1701 W, SPA 1702 W, SPA 1200</p>	0920016529
<p>Filter cartridge Assortment pack of pocket filters with mounted filter plate (as spare) Corresponds to dust class M Suitable for: SPA 2001 W, SPA 2001 D, SPA 2002 W, SPA 2002 D</p>	0913059441

Chip collection bags

	Order no.
 <p>Chip collection bag 480 x 806 mm, 120 µ , transparent Suitable for: SPA 1000, SPA 1100, SPA 1101 Sales unit: 10</p>	0913007123
<p>Chip collection bag 613 x 1180 mm, 120 µ , transparent Suitable for: SPA 1700 D, SPA 1701 W, SPA 1702 W, SPA 1200 Sales unit: 10</p>	0913017617
<p>Chip collection bag 785 x 1290 mm, 150 µ , transparent Suitable for: SPA 2000 D Sales unit: 10</p>	0913013581

	Order no.
<p>Chip collection bag 854 x 1320 mm, 200 µ , transparent Suitable for: SPA 2001 W, SPA 2001 D, SPA 2002 D, SPA 2002 W Sales unit: 10</p>	0913059433
<p>Dust bags Chip bags as replacement for the EOB 9228 Suitable for: AG 2416 Sales unit: 10</p>	630896000
<p>Dust bags Particularly tear-resistant and robust Suitable for: AG 2417 Sales unit: 5</p>	631756000

Suction hoses, Ø 100 mm



Length m	Diameter mm	Order no.
5	100	7854112915
10	100	7854115035
2,5	100	630895000





Hose connection sets, Ø 100 mm







- For the length extension of the standard hose of the chip and dust extraction units
- Including adapter and transition ring

	Order no.
<p>Hose connection set Length: 2.5 m Suitable for: SPA 1000, SPA 1100, SPA 1101, SPA 1700 D, SPA 1701 W, SPA 1702 W, SPA 1200</p>	0913010779
<p>Hose connection set Length: 2 m Low flammability with inserted earth cable Suitable for: SPA 2000 D, SPA 2001 W, SPA 2001 D, SPA 2002 D, SPA 2002 W</p>	0913013565











Suction adapter

	Order no.
 <p>Suction adapter KGS For connecting the crosscut and mitre saws to the Metabo all-purpose vacuum cleaner Suitable for: KGS 255, KGS 301, KGS 303, KGS 305, KGT 300</p>	0910059955*
 <p>Suction adapter Multi For the connection of crosscut and mitre saws and mobile table saws For KGS 303 only with chip and dust extraction unit order no. 0910057561 Suitable for: SPA 1000, SPA 1100, SPA 1101, SPA 1700 D, SPA 1701 W, SPA 1702 W, SPA 2000 D, SPA 2001 D, SPA 2001 W, SPA 2002 D, SPA 2002 W, SPA 1200</p>	0910058010*
 <p>Suction adapter For the connection of wet/dry vacuum cleaners to the wood processing machines Suitable for: SPA 1000, SPA 1100, SPA 1101, SPA 1700 D, SPA 1701 W, SPA 1702 W, SPA 2000 D, SPA 2001 D, SPA 2001 W, SPA 2002 D, SPA 2002 W, SPA 1200</p>	0910031260*
 <p>Universal adapter As a coupling for transition ring or extraction nozzle DH 330 As a hose connection for the cleaning nozzle Suitable for: SPA 1000, SPA 1100, SPA 1101, SPA 1700 D, SPA 1701 W, SPA 1702 W, SPA 2000 D, SPA 2001 D, SPA 2001 W, SPA 2002 D, SPA 2002 W, SPA 1200</p>	0913031288

*Self-service packaging

Diversion		Order no.
 Ø 93 mm	Diversion For connecting 2 hoses to the chip and dust extraction unit Suitable for: SPA 1000, SPA 1100, SPA 1101, SPA 1700 D, SPA 1701 W, SPA 1702 W, SPA 2000 D, SPA 2001 D, SPA 2001 W, SPA 2002 D, SPA 2002 W, SPA 1200	0913031296
Nozzles		Order no.
 Ø 99 mm	Cleaning nozzle For cleaning floors and machines Suitable for: SPA 1000, SPA 1100, SPA 1101, SPA 1700 D, SPA 1701 W, SPA 1702 W, SPA 2000 D, SPA 2001 D, SPA 2001 W, SPA 2002 D, SPA 2002 W, SPA 1200	0913031270
Transition rings		Order no.
 Ø 99 mm Ø 100 mm	Transition ring As a coupling for the universal adapter and for the diversion Supplied as standard with all chip and dust extraction units Suitable for: SPA 1000, SPA 1100, SPA 1101, SPA 1700 D, SPA 1701 W, SPA 1702 W, SPA 2000 D, SPA 2001 D, SPA 2001 W, SPA 2002 D, SPA 2002 W, SPA 1200	0913031300*
 Ø 58 mm Ø 100 mm	Reducing sleeve Required for connecting the dust extractor to the Magnum TK 1066 and TKU 225 machines	630841000*

Accessories for hot air guns

Nozzles		Order no.
	Wide jet nozzle, 50 mm ■ For drying and for removing paint Suitable for H 16-500, HE 20-600, HE 23-650 Control, H 1600, HE 2000, HE 2300 Control, HG 18 LTX 500	630001000*
	Wide jet nozzle, 75 mm ■ Stripping old paint from larger surfaces Suitable for H 16-500, HE 20-600, HE 23-650 Control, H 1600, HE 2000, HE 2300 Control, HG 18 LTX 500	630002000*
	Deflector nozzle, 75 mm ■ For removing old paint on window frames, for waxing and de-waxing skis Suitable for H 16-500, HE 20-600, HE 23-650 Control, H 1600, HE 2000, HE 2300 Control, HG 18 LTX 500	630003000*
	Wrap around nozzle ■ For warming plastic tubes etc. prior to bending and shaping; shrinking on shrink-fit plastic sleeves, (e.g. on cable ends) suitable for H 16-500, HE 20-600, HE 23-650 Control, H 1600, HE 2000, HE 2300 Control, HG 18 LTX 500	630004000*
	Reducing nozzle, 20 mm ■ For spot-heating e.g. soldering and welding Suitable for H 16-500, HE 20-600, HE 23-650 Control, H 1600, HE 2000, HE 2300 Control, HG 18 LTX 500	630022000*
	Reducing nozzle 9 mm ■ For attaching the slit nozzle 630006000 and the welding nozzle 630007000. Also suitable for spot-heating, (e.g. soldering and welding) ■ For hot air guns with electronics only Suitable for HE 20-600, HE 23-650 Control, HE 2000, HE 2300 Control, HG 18 LTX 500	630005000*
	Reducing nozzle, 14 mm ■ For spot-heating e.g. soldering and welding ■ Compatible with wide slit nozzle 630000000 (for welding of film) ■ For hot air guns with electronics only Suitable for H 16-500, HE 20-600, HE 23-650 Control, H 1600, HE 2000, HE 2300 Control, HG 18 LTX 500	630011000*
	Wide slit nozzle ■ For welding of film ■ The reducing nozzle 630011000 is required to fit the nozzle ■ For hot air guns with electronics only suitable for HE 20-600, HE 23-650 Control, HE 2000, HE 2300 Control, HG 18 LTX 500	630000000*
	Slit nozzle ■ For overlap-welding of PVC tarpaulins and sheeting ■ The reducing nozzle 630005000 is required to fit the nozzle ■ For hot air guns with electronics only Suitable for HE 20-600, HE 23-650 Control, HE 2000, HE 2300 Control, HG 18 LTX 500	630006000*
	Welding nozzle ■ For working with plastic welding wire (up to diameter 5 mm!) ■ The reducing nozzle 630005000 is required to fit the welding nozzle. ■ For hot air guns with electronics only Suitable for HE 20-600, HE 23-650 Control, HE 2000, HE 2300 Control, HG 18 LTX 500	630007000*

* Self-service packaging

Accessories for staplers

Staples type 4, 4 mm wide



- Narrow crown staples to fix panels and wood profiles

Width mm	Length mm	Stainless	Suitable for	Sales unit	Order no.
4	12		Ta E 2019	2.000	630901000*
4	18		Ta E 2019, Ta E 3030, Ta M 3034	2.000	630903000*
4	23		Ta E 3030, Ta M 3034	2.000	630904000*
4	26		Ta E 3030, Ta M 3034	2.000	630905000*
4	30		Ta E 3030, Ta M 3034	2.000	630906000*

Staples type 53, 10 mm wide



- Fine wire staples to fix material and fabric

Width mm	Length mm	Suitable for	Sales unit	Order no.
10	8	Ta E 2019	1.000	630570000*
10	10	Ta E 2019	1.000	630571000*
10	12	Ta E 2019	1.000	630572000*
10	14	Ta E 2019	1.000	630573000*
10	18	Ta E 2019	1.000	630574000*

Flat wire staples type 53 F, 10 mm wide



- Flat wire staples to fix films

Width mm	Length mm	Suitable for	Sales unit	Order no.
10	8	Ta E 2019	2.000	630576000*

Nails



- Nails to fix skirtings and other wood fixtures

Length mm	Suitable for	Sales unit	Order no.
19	Ta E 2019, Ta E 3030, Ta M 3034	1.000	630593000*
25	Ta E 3030, Ta M 3034	1.000	630907000*
30	Ta E 3030, Ta M 3034	1.000	630908000*

Accessories for glue guns

Hot-melt type glue sticks, light yellow



- For gluing wood, cardboard, leather, etc. (firm glue joints after just brief pressing time)
- Setting time measured for a 3 mm thick bead of glue on wood at 20 °C

Colour	Open time of adhesive Seconds	Weight kg	Order no.
Light yellow	approx. 25	0,5	630887000*
Light yellow	approx. 25	20	630891000

Hot-melt type glue sticks, transparent



- Also suitable for gluing plastics (e.g. polystyrene, polyester and polyamide), fabrics, etc. (strong, elastic glue joints)

Colour	Open time of adhesive Seconds	Weight kg	Order no.
Transparent	approx. 35	0,5	630886000*
Transparent	approx. 35	20	630889000

Additional nozzles



- Consisting of threaded bush and 2 nozzles (crevice nozzle and round nozzle) for screwing into the threaded bush

Order no.

630885000*

Accessory for cordless caulking guns

Cartridge tube



Cartridge tube

- Cartridge tube 400 ml incl. rack and push plate for standard foil bags and cartridges

Order no.

630148000*

Accessory for cordless blind rivet gun

Chuck jaws





Chuck jaws

- Especially hardened chuck jaws, therefore low-wear and long service life



Order no.

627355000*







Accessories for the cordless site light

Tripods		Order no.
	<p>Tripod for cordless site light</p> <ul style="list-style-type: none"> Telescopic legs with quick locking and additional central telescopic extension Stable support thanks to non-slip rubberised feet, tripod feet secured together with chains Easy to transport thanks to carry strap and bag <p>Working height: 85 cm – 173 cm Connecting thread: 5/8" Weight: 5 kg</p>	623729000
	<p>Construction tripod</p> <ul style="list-style-type: none"> Multi-purpose aluminium construction tripod Ideal for working on the cutting check line Telescopic legs with quick locking and anti-splay stop Geared column with metric gauge for fine adjustment of height Removable tripod head for convenient setup Good stability thanks to non-slip rubber feet Adapter for connecting different devices Easy to transport thanks to carry strap and bag <p>Working height: 74 cm – 192 cm Working height including extension piece: up to 265 cm Connecting thread: 1/4"+ 5/8" Weight: 5 kg</p>	628791000
Protective screen		Order no.
	<p>Protective screen, matt</p> <ul style="list-style-type: none"> Replacement protective screen for cordless site light Suitable for cordless site light with order no. 602111010 and 602122850 	623569000*

Accessories for measuring technology

		Order no.
	<p>Construction tripod</p> <ul style="list-style-type: none"> Multi-purpose aluminium construction tripod Ideal for working on the cutting check line Telescopic legs with quick locking and anti-splay stop Geared column with metric gauge for fine adjustment of height Removable tripod head for convenient setup Good stability thanks to non-slip rubber feet Adapter for connecting different devices Easy to transport thanks to carry strap and bag <p>Working height: 74 cm – 192 cm Working height including extension piece: up to 265 cm Connecting thread: 1/4" + 5/8" Weight: 5 kg</p>	628791000
	<p>Telescopic support</p> <ul style="list-style-type: none"> Variable positioning up to 290 cm Clamped at the touch of a button thanks to quick feed Rubberised boards permit use on slanted ceilings Ideal for laser measurement devices or site lights <p>Load capacity up to 60 kg Connecting thread: 1/4" + 5/8" Transport height: 145 cm Weight: 2.5 kg</p>	628790000

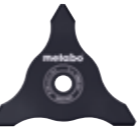
Accessories for cordless brush cutter



		Order no.
	<p>Back carry strap</p> <ul style="list-style-type: none"> For ergonomic and safe working also in continuous mode Padded in the back and shoulder area for ideal load distribution Fast attachment thanks to practical carabiner 	628428000*
	<p>Replacement spool with thread</p> <ul style="list-style-type: none"> For mowing and trimming applications Two-threaded system for fast work progress Easy readjustment of the line by means of short tapping of the spool head while working Metabo quick thread change: fast and without tools, without removing or opening the spool Suitable for the cordless brush cutters FSD and FSB 36-18 LTX BL 40 <p>Thread length: 4 m Thread diameter: 2 mm Thread type: M10 x 1.25 LH</p>	628429000*
	<p>Replacement thread Ø 2 mm, spiral-shaped</p> <ul style="list-style-type: none"> Spiral-shaped mowing thread for grass, light weeds and trimming applications Powerful and low-noise cuts with little wear thanks to impact-proof material with flexible core Suitable for normal thread heads <p>Thread length: 30 m Thread diameter: 2 mm</p>	628423000*
	<p>Replacement thread Ø 2 mm, wave-shaped</p> <ul style="list-style-type: none"> Wave-shaped mowing thread for grass, light weeds and trimming applications Energy-saving thread profile for powerful cuts with maximum runtime per battery charge Suitable for normal thread heads <p>Thread length: 30 m Thread diameter: 2 mm</p>	628430000*
	<p>Brush cutter</p> <ul style="list-style-type: none"> For thinning out and removal of dense undergrowth or matted grass For trimming thorny hedges <p>Diameter x thickness x bore: 255 x 2.3 x 25.4 mm</p>	628432000*
	<p>Grass blade</p> <ul style="list-style-type: none"> For large area applications in strong, dry grass or strong growth of weeds Also suitable for reed and thin bushes <p>Diameter x thickness x bore: 254 x 1.5 x 25.4 mm</p>	628433000*
	<p>Blade adapter</p> <ul style="list-style-type: none"> For installing grass or thicket blades on the cordless brush cutters 	628434000*

Accessories for cordless lawn mowers



		Order no.
	<p>Mower blade 46 cm</p> <ul style="list-style-type: none"> High-quality mower blade for mowing and mulching Large cutting width of 46 cm Suitable for the cordless lawn mower RM 36-18 LTX BL 46 	628435000*

*Self-service packaging

Accessories for hedge trimmers

	Order no.
 <p>Hedge trimmer maintenance oil spray</p> <ul style="list-style-type: none"> Based on natural oil, biodegradable <p>Pump-spray-can, with 0.3 litre capacity Sales unit: 1 Packing unit: 6</p>	630475000
 <p>Hedge trimmer maintenance oil 1 ltr</p> <ul style="list-style-type: none"> Based on natural oil, biodegradable <p>Sales unit: 1 Packing unit: 12</p>	630474000

Accessories for cordless shrub and grass shears

	Order no.
 <p>Grass blade</p> <ul style="list-style-type: none"> Grass blade for clean cutting of lawn edges Metabo quick system: tool-free quick change of the two blade attachments for fast working Practical cutting width of 11.5 cm <p>NEW</p>	628424000*
 <p>Shrub blade</p> <ul style="list-style-type: none"> Shrub blade for precise form cuts of shrubs and bushes Metabo quick system: tool-free quick change of the two blade attachments for fast working Practical cutting length of 20 cm <p>NEW</p>	628425000*
 <p>Telescopic handle</p> <ul style="list-style-type: none"> Stable telescopic handle for precise cutting of lawn edges whilst being gentle on the back Easy attachment without tools Overall length variable from 90 to 102 cm Working angle adjustable by 125° Suitable for PowerMaxx SGS 12 Q and SGS 18 LTX Q <p>NEW</p>	628426000*

Accessories for chain saws

	Order no.
 <p>Saw chain</p> <p>For Kt 1441; division: 3/8" ; drive links: 57</p>	631670000*

Accessories for cordless leaf blower

	Order no.
 <p>Shoulder strap</p> <ul style="list-style-type: none"> For powerful and safe working also in continuous mode Soft pad in the shoulder area Fast attachment thanks to practical carabiner <p>NEW</p>	628427000*

One battery, many solutions.

Cordless Alliance System (CAS) is an alliance of leading power tool brands. This permits now a number of professional applications also with cordless tools - from standard to special tasks.

Combine machines, battery packs and chargers of different brands with each other without any problems - CAS makes it possible.

www.cordless-alliance-system.com



100% compatibility with all CAS brands in the 18 V class!

LiHD. Cut the cord - keep the power.

The powerful cells of the Metabo LiHD battery packs supply enough power to tackle even the most demanding applications without cable. Thanks to the LiHD technology, Metabo is the only manufacturer worldwide to cover the performance spectrum up to 3,200 watt.

Maximum power that is available for an extremely long time, for any application.



ONE charger - ONE system.

Charging made extremely easy: one charger for all Metabo slide-on battery packs from 12 to 36 volt.

18 V



12 V

* Self-service packaging



LiHD battery packs



LiHD slide-on battery packs

- LiHD battery packs for ultimate performance and extremely long application with minimal temperature generation
- Ultra-M technology: Intelligent battery management for long-lasting battery packs with a 3 year guarantee
- Patented "AIR COOLED" charging technology
- Permanent Electronic Single Cell Protection (ESCP) when charging, for particularly long life.
- Processor-controlled charge and discharge management
- Capacity display for permanent control of the fill level
- Capacity display with almost no self-discharge



	Battery pack voltage V	Battery pack capacity Ah	Weight g	Order no.
	LiHD battery packs 12 V			
NEW	12	4	320	625349000*

	Battery pack voltage V	Battery pack capacity Ah	Weight g	Order no.
	LiHD battery packs 18 V			
	■ One battery, many solutions. 100% compatibility with all 18 V machines and chargers of the CAS brands: www.cordless-alliance-system.com			
	18	10	1.010	NEW 625549000*
	18	8	980	625369000*
	18	5,5	980	625368000*
	18	4	580	625367000*

	Battery pack voltage V	Battery pack capacity Ah	Weight g	Order no.
	LiHD battery packs DS 18 V			
	■ Battery pack with fall protection bar, easy and safe attachment with the safety connection for DS battery packs 628965000 (30cm) or 628966000 (60cm)			
	■ One battery, many solutions. 100% compatibility with all 18 V machines and chargers of the CAS brands: www.cordless-alliance-system.com			
	18	10	1.010	NEW 624991000*
	18	5,5	980	624990000*
	18	4	580	624989000*



	Battery pack voltage V	Battery pack capacity Ah	Weight g	Order no.
	LiHD battery packs 36 V			
	36	6,2	1.640	625344000

Li-ion battery packs



Li-ion slide-on battery packs "AIR COOLED" Plus

- Ultra-M technology: Intelligent battery management for long-lasting battery packs with a 3 year guarantee
- Patented "AIR COOLED" charging technology
- Permanent Electronic Single Cell Protection (ESCP) when charging, for particularly long life.
- Processor-controlled charge and discharge management
- Capacity display for permanent control of the fill level
- Capacity display with almost no self-discharge



	Battery pack voltage V	Battery pack capacity Ah	Weight g	Order no.
	Li-ion battery packs 12 V			
NEW	12	2	230	625406000*

	Battery pack voltage V	Battery pack capacity Ah	Weight g	Order no.
	Li-ion battery packs 14.4 V			
	14,4	2	330	625595000*

	Battery pack voltage V	Battery pack capacity Ah	Weight g	Order no.
	Li-ion battery packs 18 V			
	One battery, many solutions. 100% compatibility with all 18 V machines and chargers of the CAS brands: www.cordless-alliance-system.com			
	18	5,2	695	625592000* New from 7/21
	18	4	685	625591000* 625028000*
	18	2	430	625596000* 625027000*
				625026000*

	Battery pack voltage V	Battery pack capacity Ah	Weight g	Order no.
	Li-ion battery packs 36 V			
	36	5,2	1.400	625529000*
	36	1,5	690	625453000*

Li-ion battery packs 12 V





- Ultra-M technology: Intelligent battery management for long-lasting battery packs with a 3 year guarantee
- Permanent Electronic Single Cell Protection (ESCP) when charging, for particularly long life.
- No memory effect
- Capacity display with almost no self-discharge
- Excellent environmental properties



	Battery pack voltage V	Battery pack capacity Ah	Weight g	Order no.
	Li-ion battery packs 12 V			
NEW	12	4	380	625585000*
	12	2	185	625438000*

* Self-service packaging

Chargers, desktop chargers

	Order no.
 <p>NEW</p> <p>CAS CORDLESS ALLIANCE SYSTEM</p> <p>Double quick charger ASC 145 DUO</p> <ul style="list-style-type: none"> Double quick chargers: For charging all Li-Ion and LiHD slide-on battery packs (12 V - 36 V) Patented "AIR COOLED" charging technology: battery pack cooling during charging for significantly reduced charging times Very low stand-by input power Processor-controlled charging management for gentle charging and maximum number of charging cycles For charging of all CAS brands battery packs: www.cordless-alliance-system.com Two USB ports with 1.5 A charging current each <p>Battery voltage: 12 - 36 V Mains voltage: 230 - 240 V Mains frequency: 50 - 60 Hz Max. charging current: 8 A</p> <p>Output rating: 145 W Charging time for 18 V/4.0 Ah: 30 min Charging time for 18 V/8.0 Ah: 60 min Weight: 1,490 g</p>	627495000*
 <p>NEW</p> <p>CAS CORDLESS ALLIANCE SYSTEM</p> <p>Quick charger ASC 145</p> <ul style="list-style-type: none"> For charging all Li-Ion and LiHD slide-on battery packs (12 V - 36 V) Patented "AIR COOLED" charging technology: battery pack cooling during charging for significantly reduced charging times Very low stand-by input power Processor-controlled charging management for gentle charging and maximum number of charging cycles One charger for everything: To charge all battery packs of the CAS brands: www.cordless-alliance-system.com <p>Battery voltage: 12 - 36 V Mains voltage: 220-240 V Mains frequency: 50 - 60 Hz Max. charging current: 8 A</p> <p>Output rating: 145 W Charging time for 18 V/4.0 Ah: 30 min Charging time for 18 V/8.0 Ah: 60 min Weight: 551 g</p>	627378000*
 <p>NEW</p> <p>CAS CORDLESS ALLIANCE SYSTEM</p> <p>Charger ASC 55</p> <ul style="list-style-type: none"> For charging all Li-Ion and LiHD slide-on battery packs (12 V - 36 V) with adapted battery pack charging current Patented "AIR COOLED" charging technology: battery pack cooling during charging for significantly reduced charging times Very low stand-by input power Processor-controlled charging management for gentle charging and maximum number of charging cycles One charger for everything: To charge all battery packs of the CAS brands: www.cordless-alliance-system.com <p>Battery voltage: 12 - 36 V Mains voltage: 220-240 V Mains frequency: 50 - 60 Hz Max. charging current: 3 / 4 A</p> <p>Output rating: 55 W Charging time for 18 V/4.0 Ah: 80 min Charging time for 18 V/8.0 Ah: 160 min Weight: 582 g</p>	627044000*
 <p>NEW</p> <p>CAS CORDLESS ALLIANCE SYSTEM</p> <p>Desktop quick charger ASC 55 MULTI 8</p> <ul style="list-style-type: none"> Fast, parallel charging of up to eight Li-Ion and LiHD slide-on battery packs from 12 - 36 volts; no time loss when charging multiple batteries at once Patented "AIR COOLED" charging technology: battery pack cooling during charging for significantly reduced charging times Robust aluminium housing with hook for space-saving wall mounting. With carry handle for mobile use With a lead (680 watts) for 8 full-power charging stations with process-controlled charging management for each individual battery bay Space-saving and tidy solution, ideal for medium-sized and large industrial/trade companies Easy maintenance, requiring only annual BGVa3 test for lead cable, rather than 8 tests One charger for everything: To charge all battery packs of the CAS brands: www.cordless-alliance-system.com <p>Side on/off switch for the entire desktop charger</p> <p>Battery voltage: 12 - 36 V Mains voltage: 230 - 240 V Mains frequency: 50 - 60 Hz Max. charging current: 3 A</p> <p>Output rating: 55 W Charging time for 18 V/4.0 Ah: 80 min Charging time for 18 V/8.0 Ah: 160 min</p>	627093000
 <p>Charger LC 40</p> <ul style="list-style-type: none"> For charging Li-ion battery packs 10.8 V Charging time 2.0 Ah: 53 min; charging time 4.0 Ah: 105 min <p>Battery pack voltage: 10.8 V Mains voltage: 220-240 V Mains frequency: 50 - 60 Hz</p> <p>Max. charging current: 2.3 A Weight: 355 g</p>	627064000*









* Self-service packaging

	Order no.
 <p>NEW</p> <p>Charger LC 12</p> <ul style="list-style-type: none"> For charging Li-ion battery packs 10.8 - 12 V Charging time 2.0 Ah: 120 min; charging time 4.0 Ah: 240 min <p>Battery pack voltage: 10.8 - 12 V Mains voltage: 220-240 V Mains frequency: 50 - 60 Hz</p> <p>Max. charging current: 1 A Weight: 200 g</p>	627108000*

Adapter for battery packs

Adapter for slide-on battery packs 12 V		Order no.
 <p>PowerMaxx 12 V Adapter</p> <ul style="list-style-type: none"> The battery pack adapter is required to operate PowerMaxx machines for 10.8 or 12V push-in battery packs alternatively with a 12V slide-on battery pack. 		625225000*

Basic sets battery packs with charger

	Order no.
<p>12 V</p>  <p>Basic Set 12V 2 x 2.0 Ah</p> <ul style="list-style-type: none"> 2 x Li-Power Battery Pack 12 V/2.0 Ah Charger SC 30 Type of battery pack: Li-Ion Battery pack voltage: 12 V Battery pack capacity: 2.2 	685300000
<p>12 V</p> <p>LiHD TECHNOLOGY</p>  <p>Basic Set 12V 2 x LiHD 4.0 Ah</p> <ul style="list-style-type: none"> 2 x LiHD battery pack 12 V/4.0 Ah Charger ASC 55 Type of battery pack: LiHD Battery pack voltage: 12 V Battery pack capacity: 2.4 	685301000
<p>18 V</p> <p>CAS CORDLESS ALLIANCE SYSTEM</p>  <p>Basic Set 2 x 2.0 Ah</p> <ul style="list-style-type: none"> 2 x Li-Power battery pack 18 V/2.0 Ah Charger SC 30 	685161000
 <p>Basic Set 2 x 4.0 Ah</p> <ul style="list-style-type: none"> 2 x Li-Power battery pack 18 V/4.0 Ah Charger ASC 55 	685050000
 <p>Basic Set 3 x 4.0 Ah</p> <ul style="list-style-type: none"> 3 x Li-Power battery pack 18 V/4.0 Ah Charger ASC 55 	685049000
 <p>Basic Set 3 x 5.2 Ah</p> <ul style="list-style-type: none"> 3 x Li-Power battery pack 18 V/5.2 Ah Quick charger ASC 145 	685048000
 <p>Basic set 2 x 5.2 Ah</p> <ul style="list-style-type: none"> 2 x Li-Power battery pack 18 V/5.2 Ah Quick charger ASC 145 	685051000
 <p>Basic set 2 x 4.0 Ah + metaBOX</p> <ul style="list-style-type: none"> 2 x Li-Power battery pack 18 V/4.0 Ah Charger ASC 55 metaBOX 145 	685064000
 <p>Basic set 2 x 5.2 Ah + metaBOX</p> <ul style="list-style-type: none"> 2 x Li-Power battery pack 18 V/5.2 Ah Quick charger ASC 145 metaBOX 145 	685065000

18 V



	Order no.
Basic set 2 x LiHD 4.0 Ah 2 x LiHD battery pack 18 V/4.0 Ah Charger ASC 55	685163000
Basic set 3 x LiHD 4.0 Ah 3 x LiHD battery pack 18 V/4.0 Ah Charger ASC 55	685132000
Basic set LiHD 1 x 4.0 Ah + 1 x 5.5 Ah 1 x LiHD battery pack 18 V/4.0 Ah + 1 x LiHD battery pack 18 V/5.5 Ah Charger ASC 55	685160000
Basic set 2 x LiHD 5.5 Ah 2 x LiHD battery packs 18 V/5.5 Ah Quick charger ASC 145	685122000
Basic set 3 x LiHD 5.5 Ah 3 x LiHD battery pack 18 V/5.5 Ah Quick charger ASC 145	685074000
Basic set 2 x LiHD 4.0 Ah + metaBOX 2 x LiHD battery pack 18 V/4.0 Ah Quick charger ASC 145 metaBOX 145	685130000
Basic set 3 x LiHD 4.0 Ah + metaBOX 3 x LiHD battery pack 18 V/4.0 Ah Charger ASC 55 metaBOX 145	685133000
Basic set LiHD 1 x 4.0 Ah + 1 x 5.5 Ah + metaBOX 1 x LiHD battery pack 18 V/4.0 Ah + 1 x LiHD battery pack 18 V/5.5 Ah Charger ASC 55 metaBOX 145	685136000
Basic set 2 x LiHD 5.5 Ah + metaBOX 2 x LiHD battery packs 18 V/5.5 Ah Quick charger ASC 145 metaBOX 145	685077000
Basic Set 3 x LiHD 5.5 Ah + metaBOX 3 x LiHD Battery Pack 18 V/5.5 Ah Quick charger ASC 145 metaBOX 145	685069000
Basic set 4x LiHD 5.5Ah ASC 145 DUO + metaBOX Basic set 4x LiHD 5.5 Ah 1 x ASC 145 Duo metaBOX 145	685180000
Basic set 2 x LiHD 8.0 Ah + metaBOX 2 x LiHD battery pack 18 V/8.0 Ah Quick charger ASC 145 metaBOX 145	685131000
Basic set 4 x LiHD 8.0 Ah + 2 x ASC 145 Duo + metaBOX 4 x LiHD battery pack 18 V/8.0 Ah Quick charger ASC 145 Duo metaBOX 145	685135000
Basic set 2 x LiHD 10 Ah + metaBOX 2 x LiHD battery pack 18 V/10.0 Ah Quick charger ASC 145 metaBOX 215	NEW 685142000
Basic set 4 x LiHD 10 Ah + metaBOX 4 x LiHD battery pack 18 V/10.0 Ah Quick charger ASC 145 DUO metaBOX 215	NEW 685143000

metaBOX

The new transport and storage system.

The solution for:

Workshop



Transport



Construction site



Robust



- Maximum load 125 kg
- Protection against dirt and moisture IP43
- Stable and ergonomic handles

Can be stacked



- In all system widths
- With MetaLoc and other case solutions

Can be coupled

- Fast. With one handle. In all system widths.
- A box in the stack can easily be opened without having to decouple it



Mobile

metaBOX trolley

- Easy transport of metaBox and working material up to 100 kg



metaBOX adapter plate

- Suitable for Sortimo vehicle car equipment Globelyst and SR5













metaBOX system

metaBOX

- Intelligent transport and storage system for mobile working
- Extremely robust and break-proof due to the material (ABS) and design for maximum resilience
- Optimum protection of machine and accessories against dirt and moisture (IP43)
- Fast and easy stacking and coupling of the boxes in all system widths
- One box in the stack can easily be opened without having to decouple it
- A selection of two: Comfortable front handle for carrying the box near you and extra-wide cover handle to carry several stacked-up boxes
- Numerous tailor-made inserts (accessories) for individual order inside the box
- Clever accessories: Roller board for maximum mobility as well as an adapter plate to secure the boxes in the vehicle



NEW

	Order no.
 metaBOX 118 empty, without inserts Dimensions: 396 x 296 x 118 mm Weight: 1.3 kg	626882000
 metaBOX 145 empty, without inserts Dimensions: 396 x 296 x 145 mm Weight: 1.57 kg	626883000
 metaBOX empty 215, without inserts Dimensions: 396 x 296 x 215 mm Weight: 1.92 kg	626887000
 metaBOX 340 empty, without inserts Dimensions: 396 x 296 x 340 mm Weight: 2.51 kg	626888000
 metaBOX 145 L empty, without inserts Dimensions: 496 x 296 x 145 mm Weight: 1.85 kg	626884000
 metaBOX 165 L empty, without inserts Max. load cover: 125 kg Weight: 1.95 kg	626889000
 metaBOX 118, suitable for BS / SB, 12V Dimensions: 396 x 296 x 118 mm Weight: 1.56 kg	626885000
 metaBOX 145, suitable for BS L / BS LT / SB L / SB LT, 18V Dimensions: 396 x 296 x 145 mm Weight: 1.64 kg	626886000
 metaBOX 145 L, suitable for BS LTX / SB LTX, 18V Dimensions: 496 x 296 x 145 mm Weight: 1.99 kg	626891000
 metaBOX 145 L, suitable for SBE / KHE / UHE Dimensions: 496 x 296 x 145 mm Weight: 2 kg	626892000
 metaBOX 165 L, suitable for angle grinders up to disc Ø 125 mm Dimensions: 496 x 296 x 165 mm Weight: 2.29 kg	626890000

Storage solutions



NEW

metaBOX 118 organizer

- Intelligent transport and storage system for small parts and accessories
 - Maximum overview thanks to the twelve Sortimo insertion boxes in different sizes that can be positioned freely
 - Safe plug-in connection of each insertion box in the base of the organiser, which permits the use of individual boxes
 - With twelve labels for individual identification of the contents
- Set consisting of 4 of each insertion boxes 1x1 H63 (52 mm x 52 mm x 63 mm); 5x insertion boxes 1x2 H63 (104 mm x 52 mm x 63 mm); 2x insertion boxes 2x2 H63 (104 mm x 104 mm x 63 mm); 1x insertion boxes 2x3 H63 (157 mm x 104 mm x 63 mm)
Dimensions: 396 x 296 x 118 mm
Weight: 1.3 kg

Order no.

626897000

Transport accessories



NEW

metaBOX trolley

- Maximum mobility in the workshop and on the construction site
- Easy transport of metaBox and working material up to 100 kg
- High degree of flexibility thanks to 4 rubberised castors that can be turned by 360° and 2 lock brakes
- Comfortable coupling of the bottom metaBOX with the trolley thanks to foot operation
- Side handles for easy carrying
- Recesses for hanging in clamping straps to secure the load
- Suitable for metaBOX and metaBOX L

Order no.

626894000

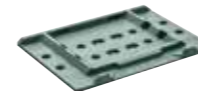

NEW

metaBOX adapter plate

- For the securing and orderly placement of boxes in the vehicle
- Suitable for Sortimo vehicle equipment Globelyst and SR5
- Easy removal of the metaBOX by lifting from the handle
- Suitable for metaBOX and metaBOX L
- Easy and fast fixing in the vehicle equipment with the supplied screws





Order no.

















626895000







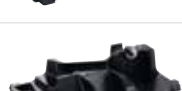









Inserts for machines and accessories

- Precisely customised insert for tools and accessories
- Material: PS (polystyrol)

NEW

	Order no.
 Machine insert for cordless angle grinder CC 18 LTX BL Suitable for metaBOX 165 L, empty Dimensions: 473 x 278 mm Weight: 0.27 kg	628875000
 Machine insert for cordless sabre saw SSE 12 BL/18 LTX/18 LTX BL Compact Suitable for metaBOX 145, empty Dimensions: 373 x 260 mm Weight: 0.24 kg	628876000
 Machine insert for cordless circular saw MKS 18 LTX 58 / KS 18 LTX 57 Suitable for metaBOX 340, empty Dimensions: 373 x 260 mm Weight: 0.3 kg	628877000
 Machine insert for cordless sabre saw SSE 18 LTX BL Suitable for metaBOX 145 L, empty Dimensions: 473 x 278 mm	628878000
 Machine insert for cordless multi-tool MT 18 LTX Compact / MT 18 LTX BL QSL Suitable for metaBOX 145 L, empty Dimensions: 473 x 278 mm Weight: 0.35 kg	628879000

	Order no.
 Machine insert for cordless rotary hammer KHA 18 LTX / SBE 18 LTX Suitable for metaBOX 165 L, empty Dimensions: 473 x 278 mm Weight: 0.26 kg	628880000
 Machine insert for cordless angle grinder WB 18 LTX BL150 Quick / 18 LTX BL 180 Suitable for metaBOX 165 L, empty Dimensions: 473 x 278 mm Weight: 0.32 kg	628881000
 Machine insert for cordless jigsaw STA 18 LTX 100 / STAB 18 LTX 100 Suitable for metaBOX 145 L, empty Dimensions: 473 x 278 mm Weight: 0.27 kg	628882000
 Machine insert for cordless rotary hammer KHA 18 LTX BL 24 Quick Suitable for metaBOX 165 L, empty Dimensions: 473 x 278 mm Weight: 0.32 kg	628883000
 Machine insert for cordless nibbler NP 18 LTX BL 5.0 Suitable for metaBOX 145 L, empty Dimensions: 473 x 278 mm Weight: 0.26 kg	628884000
 Machine insert for cordless combination sets with BS / SB / SSD Suitable for metaBOX 145, empty Dimensions: 373 x 260 mm Weight: 0.24 kg	628885000
 Machine insert for cordless combination sets BL with BS / SB / SSD / SSW Suitable for metaBOX 145 L, empty Dimensions: 473 x 278 mm Weight: 0.27 kg	628886000
 Machine inserts for cordless impact wrench SSW 18 LTX 600 Suitable for metaBOX 145 L, empty Dimensions: 473 x 278 mm Weight: 0.32 kg	628887000
 Machine insert for cordless jigsaw STA 18 LTX 140 Suitable for metaBOX 145 L, empty Dimensions: 473 x 278 mm Weight: 0.32 kg	628888000
 Machine insert for cordless combination sets with BS / SB / WS Suitable for metaBOX 165 L, empty Dimensions: 473 x 278 mm Weight: 0.27 kg	628889000
 Machine insert for cordless planer HO 18 LTX 20-82 Suitable for metaBOX 340, empty Dimensions: 373 x 260 mm Weight: 0.26 kg	628890000
 Machine insert for cordless sabre saw ASE 18 LTX Suitable for metaBOX 145 L, empty Dimensions: 473 x 278 mm Weight: 0.32 kg	628891000
 Machine insert for cordless combination sets 12V with BS / SB / SSE Suitable for metaBOX 145 L, empty Dimensions: 473 x 278 mm Weight: 0.27 kg	628893000
 Machine insert for cordless drill BE 18 LTX 6 Suitable for metaBOX 145, empty Dimensions: 373 x 260 mm Weight: 0.24 kg	628894000
 Machine insert for cordless die grinder GA 18 LTX Suitable for metaBOX 145 L, empty Dimensions: 473 x 278 mm Weight: 0.32 kg	628895000
 Machine insert for cordless angle grinder W 18 LTX 150 Quick Suitable for metaBOX 165 L, empty Dimensions: 473 x 278 mm Weight: 0.32 kg	628896000

	Order no.
 Machine insert for circular saw KS 66 FS Suitable for metaBOX 340, empty Dimensions: 373 x 260 mm Weight: 0.24 kg	628897000
 Machine insert for paint remover LF 724 S Suitable for metaBOX 145, empty Dimensions: 373 x 260 mm Weight: 0.24 kg	628898000
 Machine insert for jigsaw STE 140 / 140 Plus / STEB 140 Plus Suitable for metaBOX 145, empty Dimensions: 373 x 260 mm	628899000
 Machine insert for rotary hammer KHE 3250 / KHE 3251 Suitable for metaBOX 165 L, empty Dimensions: 473 x 278 mm	628901000
 Machine insert for multi-tool MT 400 Quick Suitable for metaBOX 145, empty Dimensions: 373 x 260 mm	628902000
 Machine insert for orbital sander SRE 4350 TurboTec / SRE 4351 TurboTec Suitable for metaBOX 165 L, empty Dimensions: 473 x 278 mm Weight: 0.27 kg	628903000
 Machine insert for angle grinder WF 18 LTX 125 / WF 18 LTX 125 Quick Suitable for metaBOX 165 L, empty Dimensions: 473 x 278 mm	628904000
 Machine insert for random orbital sander SXE 150-2.5 BL / SXE 150-5.0 BL Suitable for metaBOX 145, empty Dimensions: 373 x 260 mm Weight: 0.24 kg	628905000
 Machine insert for angle polisher PE 15-25 Suitable for metaBOX 165 L, empty Dimensions: 473 x 278 mm	628906000
 Machine insert for renovation grinder RSEV 17-125 Suitable for metaBOX 165 L, empty Dimensions: 473 x 278 mm Weight: 0.32 kg	628907000
 Machine insert for random orbital sander SXE 450 Turbo Tec Suitable for metaBOX 215, empty Dimensions: 373 x 260 mm Weight: 0.24 kg	628908000
 Machine insert for diamond cutter system T 13-125 CED Suitable for metaBOX 340, empty Dimensions: 373 x 260 mm Weight: 0.24 kg	628909000
 Machine insert for router OF E 1229 SIGNAL Suitable for metaBOX 340, empty Dimensions: 373 x 260 mm Weight: 0.24 kg	628910000
 Machine insert for cordless bevelling tool KFM 18 LTX 3 RF / KFM 9-3 RF Suitable for metaBOX 215, empty Dimensions: 373 x 260 mm	628911000
 Machine insert for multi-line laser MLL 3-20 Suitable for metaBOX 145, empty Dimensions: 373 x 260 mm Weight: 0.24 kg	628912000
 Machine insert for Metaloc grinding media set 150 Suitable for metaBOX 215, empty Dimensions: 373 x 260 mm Weight: 0.21 kg	628913000

17

18

19

20

21

22

23

24

25

26

27















28

29



30

31

32

	Order no.
 <p>Machine insert for planer HO 26-82 Suitable for metaBOX 215, empty Dimensions: 373 x 260 mm</p>	628914000
 <p>Machine insert for cordless hot air gun HG 18 LTX 500 Suitable for metaBOX 145 L, empty Dimensions: 473 x 278 mm Weight: 0.31 kg</p>	628915000
 <p>Machine insert for cordless angle grinder PowerMaxx CC 12 BL Suitable for metaBOX 145, empty Dimensions: 373 x 260 mm Weight: 0.2 kg</p>	628916000
 <p>Machine insert for cordless nibbler / cordless metal shears SCV 18 LTX BL 1.6 Suitable for metaBOX 145, empty Dimensions: 373 x 260 mm Weight: 0.2 kg</p>	628917000
 <p>Machine insert for cordless shrub and grass shears PowerMaxx SGS 12 Q Suitable for metaBOX 145, empty Dimensions: 373 x 260 x 10 mm</p>	628918000
 <p>Machine insert for cordless shrub and grass shears SGS 18 LTX Q Suitable for metaBOX 145 L, empty Dimensions: 473 x 278 mm</p>	628919000
 <p>Machine insert for cordless rotary hammer PowerMaxx BH 12 BL 16 Suitable for metaBOX 145, empty Dimensions: 373 x 260 mm</p>	628920000
 <p>Machine insert for cordless rotary hammer BH 18 LTX BL 16 Suitable for metaBOX 145 L, empty Dimensions: 473 x 278 mm Weight: 0.31 kg</p>	628921000
 <p>Battery pack insert for Li-Power and LiHD battery pack basic sets Suitable for metaBOX 145, empty Dimensions: 373 x 260 mm</p>	628922000
 <p>Machine insert for cordless plunge cut circular saw KT 18 LTX 66 BL Suitable for metaBOX 340, empty Dimensions: 373 x 260 mm</p>	628923000
 <p>Machine insert for hot air gun, mains powered Suitable for metaBOX 145, empty Dimensions: 373 x 260 mm</p>	628924000
 <p>Machine insert for 2,200 watt hot air gun HGS 22-630 Suitable for metaBOX 145, empty Dimensions: 373 x 260 mm</p>	628925000
 <p>Machine insert for cordless rotary hammer KHA 36-18 LTX 32 Suitable for metaBOX 165 L, empty Dimensions: 473 x 278 mm Weight: 0.36 kg</p>	628926000
 <p>Foam insert Inert can be cut individually for optimal and safe storage With foam partition that can be cut to size 16x16x25mm Optimised storage permits easy access to the contents 4-piece set consisting of: convoluted foam, self-adhesive for the cover (25 mm), 1x foam without perforation and 2x foam with perforation (16x16x25mm)</p>	
Dimensions: 396 x 296 mm	626898000
Dimensions: 496 x 296 mm	626899000



Accessories for MetaLoc cases

	Order no.
 <p>Metadepot</p> <ul style="list-style-type: none"> For practical storage of pipes, cables and accessories. Provides the combination of Metabo all-purpose vacuum cleaners with the MetaLoc system and metaBOX system Numerous possible uses, e.g. with individually configurable foam inserts (accessories) The MetaLoc stays in shape – even at extreme temperatures (-40° to +90°C) <p>suitable for: ASR 2025, ASR 2050, SHR 2050 M, ASR 25 L SC , ASR 50 L SC, ASR 50 M SC Sales unit: 1</p>	631937000
 <p>Trolley</p> <ul style="list-style-type: none"> For extra mobility for the AS 18 L PC and the MetaLocs Fast fixing of the cordless vacuum cleaners AS 18 L PC with metal clamps Secure connection of the MetaLocs by means of clamping mechanism Braked castors permit safe working on uneven surfaces 	630174000

Plastic carry case

	Order no.
 <p>Plastic carry case Plastic carry case suitable for all Metabo angle grinders with disc Ø 180 mm and 230 mm Dimensions: 175 x 730 x 315 mm</p>	625451000

Tool bags

	Order no.
 <p>Tool bag (small)</p> <ul style="list-style-type: none"> The robust and compact Metabo tool bag On the inside of the bag there are three bag compartments with hook and loop straps to take two battery packs and one charger On the outside there is a spacious pocket with zipper and two other small pockets on the left and right head with hook and loop closure for quick access Comfortable side pads and padded shoulder strap Three reflective Metabo logos for optimum visibility on the construction site Stable, integrated base plate with strips to protect the bag contents Material: water-repellent and tear-proof 600D polyester Dimensions (lxwxh): 460 mm x 260 mm x 280 mm 	657006000
 <p>Tool bag (large)</p> <ul style="list-style-type: none"> The large, practical Metabo tool bag On the inside of the bag there are five bag compartments with hook and loop straps to take three battery packs, one charger and accessories On the outside there are two spacious pockets with zipper and three other small pockets for quick access Comfortable side pads and padded shoulder strap Three reflective Metabo logos for optimum visibility on the construction site Stable, integrated base plate with strips to protect the bag contents Material: water-repellent and tear-proof 600D polyester Dimensions (lxwxh): 670 mm x 290 mm x 325 mm 	657007000

Well protected: The new tool safety equipment.







On the construction site, not only the worker must be secured, but also the tool. Even from low heights, the falling tools can cause significant damage.



The Metabo tool safety equipment guarantees safe working.

Certified in accordance with international safety standard ANSI/ISEA 121-2018





Tool safety equipment		Order no.
 NEW	Tool safety belt DC up to 5kg <ul style="list-style-type: none"> Robust securing strap with battery pack securing loop to avoid or dampen impacts when the secured tool falls No unintentional loosening of the secure connection thanks to carabiner with twist lock system High degree of free movement without twisting or jamming thanks to integrated swivel joint Clear marking of the maximum securing weight Max. securing weight: 5 kg	628969000*
 NEW	Tool safety belt: Quick Connect DS, up to 5kg <ul style="list-style-type: none"> Robust securing strap with battery pack securing loop to avoid or dampen impacts when the secured tool falls Quick connect: Ready for use in a matter of seconds thanks to carabiner with safe twist-lock system on both ends High degree of free movement without twisting or jamming thanks to integrated swivel joint Clear marking of the maximum securing weight Max. securing weight: 5 kg	628970000*
 NEW	Tool safety belt: DS, up to 20 kg <ul style="list-style-type: none"> Robust securing strap with battery pack securing loop to avoid or dampen impacts when the secured tool falls No unintentional loosening of the secure connection thanks to carabiner with twist lock system High degree of free movement without twisting or jamming thanks to integrated swivel joint Clear marking of the maximum securing weight Max. securing weight: 20 kg	628971000*
 NEW	Anchor strap up to 40 kg <ul style="list-style-type: none"> Safe anchorage and loadable extension for tool safety equipment Fast, easy fixture to the scaffolding or other suitable anchorage points Locking arms on both sides for optional fixing to the anchorage point using the tape 628964000 Clear marking of the maximum securing weight Max. securing weight: 40 kg	628968000*
 NEW	Safety connection for battery pack DS, 30 cm <ul style="list-style-type: none"> Robust safety connection for all Metabo LiHD battery pack DS variants No unintentional loosening of the secure connection thanks to carabiner with twist lock system Clear marking of the maximum securing weight Max. securing weight: 2.5 kg	628965000*

* Self-service packaging

 NEW	Safety connection for battery pack DS, 60 cm <ul style="list-style-type: none"> Robust safety connection for all Metabo LiHD battery pack DS variants No unintentional loosening of the secure connection thanks to carabiner with twist lock system Clear marking of the maximum securing weight Max. securing weight: 2.5 kg	Order no. 628966000*
 NEW	10 safety belts with D-ring up to 3 kg <ul style="list-style-type: none"> Tear-proof nylon belt with extra strong, all-round closed D-ring for maximum safety Easy and safe attachment of the safety belt on the tool using the safety tape (628964000) Clear marking of the maximum securing weight Max. securing weight: 3 kg	628963000*
 NEW	Safety tape, self-adhesive up to 5 kg <ul style="list-style-type: none"> Safety tape for easy and safe attachment of the safety belt with D-ring (628963000) on the tool Self-adhesive, flexible silicone tape for easy and fast creation of loadable connections High degree of connection safety thanks to integrated tear-proof glass fibre net If needed, the tape can be removed from the tool without leaving any residue Max. securing weight: 5 kg	628964000*

Safety goggles

		Sales unit / sales display	Order no.
	Protective goggles <ul style="list-style-type: none"> Perfect all-round protection, large field of vision thanks to specially shaped lens Excellent ventilation thanks to optimally designed side arms Special coating (outside scratch-proof, inside anti-fog) Lens colourless, UV 2 - 1.2 Use for light dust activities, mounting activities, grinding work, drilling and milling jobs 	1 piece / 5 pieces	623751000*
	Protective goggles <ul style="list-style-type: none"> Perfect all-round protection, large field of vision thanks to specially shaped lens Excellent ventilation thanks to optimally designed side arms Special coating (outside scratch-proof, inside anti-fog) Grey lens, UV 5 - 2.5, for perfect use when working outdoors Use for light dust activities, mounting activities, grinding work, drilling and milling jobs 	1 piece / 5 pieces	623752000

Working gloves M1

	<ul style="list-style-type: none"> Tailored protective glove Finish made from easy-grip, soft Amara leather on the palm, high degree of flexibility and grip Protection from mechanical stress Abrasion-proof, breathable Does not contain any substances known to cause allergies DIN EN 388 (2121X) 	Order no.
	Working gloves M1, size 9	623757000*
	Working gloves M1, size 10	623758000*

Working gloves M2

	<ul style="list-style-type: none"> Ideally shaped 5-finger knitted glove made from PA/Spandex, palm coated in black Nitrile/PU Breathable Excellent safe grip Does not contain any substances known to cause allergies DIN EN 420 	Order no.
	Working gloves M2, size 9	623759000*
	Working gloves M2, size 10	623760000*

Accessories for compressors

Oils



Compressor oil, 1 litre, for piston condenser Mineral

Order no.

0901004170

Compressed air preparation

Maintenance units



- Consisting of filter controller FR and lubricator L
- Wall mounting: Line installation and control panel installation possible

Connecting thread	Maximum inlet pressure bar	Order no.
1/4"	12	0901063869
1/2"	14	0901063850

Filter controller



- Wall mounting: Line installation and control panel installation possible

Connecting thread	Maximum inlet pressure bar	Order no.
1/4"	12	0901063877
1/2"	14	0901063885

Controller



- Wall mounting: Line installation and control panel installation possible

Connecting thread	Maximum inlet pressure bar	Order no.
1/4"	12	0901063834
1/2"	14	0901063826

Filter



- Wall mounting: Line installation and control panel installation possible

Connecting thread	Maximum inlet pressure bar	Order no.
1/4"	12	0901063818
1/2"	14	0901063800

Lubricator



- Wall mounting: Line installation and control panel installation possible

Connecting thread	Maximum inlet pressure bar	Order no.
1/4"	12	0901063796
1/2"	14	0901063788

Line lubricator



Connecting thread	Order no.
1/4"	0901054584*

Oils



Special oil 0.5 litres for compressed air tools Mineral

Order no.

0901008540

* Self-service packaging



Pipe system

Compressed air lines



Outer Ø mm	Internal Ø mm	Length m	Material	Version	Order no.
15	12	25	Plastic	Flexible (rolls)	7851194171
22	18	25	Plastic	Flexible (rolls)	7851194180

Distributors

	Order no.
 Wall disc Plastic	7876194001
 Diffuser can Brass thread Without locking screw	0901059691

Connections

Diameter mm	Connecting thread	Material	Order no.
22	3/4"	Plastic	7876193943
15	1/2"	Plastic	7876193951

■ with male thread

Plug connector

Diameter mm	Material	Order no.
T-plug connector		
15	Plastic	7876194010
22	Plastic	7876194028
Angle plug connector		
15	Plastic	7876194060
22	Plastic	7876194079
Straight plug connectors		
15	Plastic	7876194125
22	Plastic	7876194133

Pipe socket



Diameter mm	Connecting thread	Material	Order no.
15	1/2"	Plastic	7876193978
22	1/2"	Plastic	7876193986
22	3/4"	Plastic	7876193994

Air cocks



Diameter mm	Connecting thread	Order no.
15	1/2"	0901059489
22	3/4"	0901059500

Safety rings



Diameter mm	Material	Order no.
22	Plastic	7876194117

Tubular joints



Diameter mm	Material	Order no.
15	Plastic	7876693610
22	Plastic	7876693628

Pipe cutter

Order no.	
 Pipe cutter Maximum diameter: 28 mm	9109691680

Compressed air hoses

Compressed air hoses with fabric insert



- For all normal applications

Length m	Internal Ø mm	Outer Ø mm	Maximum pressure bar	Profile	Version	Order no.
5	6	11	20	Euro	With quick-action coupling and nipple	0901054908
5	6	11	20	ISO	With quick-action coupling and nipple	628779000
10	6	11	20	Euro	With quick-action coupling and nipple	0901054916
10	9	14	20	Euro	With quick-action coupling and nipple	0901054924
10	9	14	20	ISO	With quick-action coupling and nipple	628781000
50	9	14	20	-	Rolls	0901054932
50	12,5	18	12	-	Rolls	0901056161

Super Air compressed air hoses



- Very flexible hose, even at low temperatures
- Resistant against compressed air containing oil

Length m	Internal Ø mm	Outer Ø mm	Maximum pressure bar	Profile	Version	Order no.
10	6,3	11	20	Euro	With quick-action coupling and nipple	0901056048
10	6,3	11	20	ARO	With quick-action coupling and nipple	0901058903
10	10	15,5	20	Euro	With quick-action coupling and nipple	0901056056
10	10	15,5	20	ARO	With quick-action coupling and nipple	0901057290
10	10	15,5	20	ISO	With quick-action coupling and nipple	628783000
50	10	15,5	20	-	Rolls	0901057303

Spiral hoses, Rilsan



Length m	Internal Ø mm	Outer Ø mm	Maximum pressure bar	Profile	Version	Order no.
5	6	8	8	Euro	With quick-action coupling and nipple	0901054940
5	6	8	8	ARO	With quick-action coupling and nipple	0901056218
5	6	8	8	ISO	With quick-action coupling and nipple	628768000
7,5	6	8	8	Euro	With quick-action coupling and nipple	0901054959
7,5	6	8	8	ARO	With quick-action coupling and nipple	0901056226
7,5	6	8	8	ISO	With quick-action coupling and nipple	628769000
10	8	10	8	Euro	With quick-action coupling and nipple	0901054967

Spiral hose, polyurethane



- Highly elastic special hose for professional applications
- No permanent reduction of volume due to kinks
- Non-abrasive

Length m	Internal Ø mm	Outer Ø mm	Maximum pressure bar	Profile	Version	Order no.
6	8	12	8	Euro	With quick-action coupling and nipple	0901062145

Hose reels



- Hose recoiler SA 100**
- With 20 m compressed air hose with fabric insert
 - Quick connection coupling 1/4" Euro and plug-in nipple 1/4"
- Length: 20m
Internal Ø: 9 mm
External Ø: 15 mm
Maximum pressure: 15 bar
Weight: 4 kg

Order no.
0901054975



- Hose reel ST 200**
- With 30m highly flexible PU hose
 - Quick connection coupling 1/4" Universal and plug-in nipple 1/4" (Euro, ARO and ISO)
 - 360° rotating
- Length: 30m
Internal Ø: 8.5 mm
External Ø: 12.5 mm
Maximum pressure: 12 bar
Weight: 8 kg

0901054568



- Hose recoiler SA 250**
- With 8 m highly flexible PU hose
 - Quick connection coupling 1/4" Universal and plug-in nipple 1/4" (Euro, ARO and ISO)
 - Automatic function: lock and recoil simply by pulling the hose.
 - With wall and ceiling mounting brackets
 - Plastic sleeve
- Length: 8 m
Internal Ø: 8 mm
External Ø: 12 mm
Maximum pressure: 15 bar
Weight: 2.9 kg

628820000







- Hose recoiler SA 312**
- With 12 m highly flexible PU hose
 - Quick connection coupling 1/4" Universal and plug-in nipple 1/4" (Euro, ARO and ISO)
 - Automatic function: lock and recoil simply by pulling the hose.
 - With wall and ceiling mounting brackets
 - Metal housing
 - Length of connecting hose 1 m
- Length: 12 m
Internal Ø: 8 mm
External Ø: 12 mm
Maximum pressure: 12 bar
Weight: 8 kg

628824000

Brass parts

Compressed air distributor

	Version	Connecting size	Profile	Packaging	Sales unit	Order no.
	Female thread	3/8"	Euro	Self-service packaging	1	0901026645*
	Female thread	3/8"	Euro	Self-service packaging	1	0901026653*
	Female thread	3/8"	-	Self-service packaging	1	628759000*
	Female thread	3/8"	-	Self-service packaging	1	628760000*

Quick connection couplings Euro

 **Quick connection couplings Euro with male thread**
 ■ Brass coupling for plug-in nipple with Euro profile

Version	Connecting size	Packaging	Sales unit	Order no.
Male thread	1/4"	Self-service packaging	1	0901031517*
Male thread	3/8"	Self-service packaging	1	0901025894*
Male thread	1/2"	Self-service packaging	1	0901025908*
Male thread	1/4"	Loose	1	7802009083
Male thread	3/8"	Loose	1	7802009091
Male thread	1/2"	Loose	1	7802009105

 **Quick connection couplings Euro with female thread**
 ■ Brass coupling for plug-in nipple with Euro profile

Version	Connecting size	Packaging	Sales unit	Order no.
Female thread	1/4"	Self-service packaging	1	0901025916*
Female thread	3/8"	Self-service packaging	1	0901025924*
Female thread	1/2"	Self-service packaging	1	0901025932*
Female thread	1/4"	Loose	1	7801009055
Female thread	3/8"	Loose	1	7801009063
Female thread	1/2"	Loose	1	7801009071

 **Quick connection couplings Euro with nozzle**
 ■ Brass coupling for plug-in nipple with Euro profile

Version	Connecting size	Packaging	Sales unit	Order no.
with spout	6 mm	Self-service packaging	1	0901025940*
with spout	9 mm	Self-service packaging	1	0901026351*
with spout	13 mm	Self-service packaging	1	0901026360*
with spout	6 mm	Loose	1	7800009035
with spout	9 mm	Loose	1	7800009043
with spout	13 mm	Loose	1	7800009558

Quick connection couplings UNI

 **Quick connection couplings UNI with male thread**
 ■ Universal coupling for plug-in nipple with Euro, ARO or ISO profile

Version	Connecting size	Packaging	Sales unit	Order no.
Male thread	1/4"	Self-service packaging	1	628700000*
Male thread	3/8"	Self-service packaging	1	628701000*
Male thread	1/2"	Self-service packaging	1	628702000*

 **Quick connection couplings UNI with female thread**
 ■ Universal coupling for plug-in nipple with Euro, ARO or ISO profile

Version	Connecting size	Packaging	Sales unit	Order no.
Female thread	1/4"	Self-service packaging	1	628703000*
Female thread	3/8"	Self-service packaging	1	628704000*
Female thread	1/2"	Self-service packaging	1	628705000*

 **Quick connection couplings UNI with nozzle**
 ■ Universal coupling for plug-in nipple with Euro, ARO or ISO profile

Version	Connecting size	Packaging	Sales unit	Order no.
with spout	6 mm	Self-service packaging	1	628706000*
with spout	9 mm	Self-service packaging	1	628707000*
with spout	13 mm	Self-service packaging	1	628708000*

Plug-in nipple Euro

 **Plug-in nipple Euro with male thread**
 ■ For use with Euro and UNI couplings

Version	Connecting size	Packaging	Sales unit	Order no.
Male thread	1/4"	Self-service packaging	1	0901025983*
Male thread	3/8"	Self-service packaging	1	0901025991*
Male thread	1/2"	Self-service packaging	1	628736000*
Male thread	1/4"	Loose	1	7803009117
Male thread	3/8"	Loose	1	7803009133
Male thread	1/2"	Loose	1	628738000

*Self-service packaging



Plug-in nipple Euro with female thread
 ■ For use with Euro and UNI couplings

Version	Connecting size	Packaging	Sales unit	Order no.
Female thread	1/4"	Self-service packaging	1	0901026017*
Female thread	3/8"	Self-service packaging	1	0901026025*
Female thread	1/2"	Self-service packaging	1	628737000*
Female thread	1/4"	Loose	1	7803009125
Female thread	3/8"	Loose	1	7803009141
Female thread	1/2"	Loose	1	628739000



Plug-in nipple Euro with nozzle
 ■ For use with Euro and UNI couplings

Version	Connecting size	Packaging	Sales unit	Order no.
with spout	6 mm	Self-service packaging	1	0901025959*
with spout	6 mm	Self-service packaging	1	0901025967*
with spout	13 mm	Self-service packaging	1	0901025975*
with spout	6 mm	Loose	1	7804065606
with spout	9 mm	Loose	1	7804009161
with spout	13 mm	Loose	1	7804010372

Plug-in nipple ARO



Plug-in nipple ARO with male thread
 ■ For use with ARO and UNI couplings

Version	Connecting size	Packaging	Sales unit	Order no.
Male thread	1/4"	Self-service packaging	1	628730000*
Male thread	3/8"	Self-service packaging	1	628731000*
Male thread	1/2"	Self-service packaging	1	628734000*



Plug-in nipple ARO with female thread
 ■ For use with ARO and UNI couplings

Version	Connecting size	Packaging	Sales unit	Order no.
Female thread	1/4"	Self-service packaging	1	628732000*
Female thread	3/8"	Self-service packaging	1	628733000*
Female thread	1/2"	Self-service packaging	1	628735000*



Plug-in nipple ARO with nozzle
 ■ For use with ARO and UNI couplings

Version	Connecting size	Packaging	Sales unit	Order no.
with spout	6 mm	Self-service packaging	1	628720000*
with spout	9 mm	Self-service packaging	1	628721000*
with spout	13 mm	Self-service packaging	1	628722000*

Plug-in nipple ISO



Plug-in nipple ISO with male thread
 ■ For use with ISO and UNI couplings

Version	Connecting size	Packaging	Sales unit	Order no.
Male thread	1/4"	Self-service packaging	1	628747000*
Male thread	3/8"	Self-service packaging	1	628748000*
Male thread	1/2"	Self-service packaging	1	628749000*



Plug-in nipple ISO with female thread
 ■ For use with ISO and UNI couplings

Version	Connecting size	Packaging	Sales unit	Order no.
Female thread	1/4"	Self-service packaging	1	628754000*
Female thread	3/8"	Self-service packaging	1	628755000*
Female thread	1/2"	Self-service packaging	1	628756000*



Plug-in nipple ISO with nozzle
 ■ For use with ISO and UNI couplings

Version	Connecting size	Packaging	Sales unit	Order no.
with spout	6 mm	Self-service packaging	1	628740000*
with spout	9 mm	Self-service packaging	1	628741000*
with spout	13 mm	Self-service packaging	1	628746000*

Double nipple



Version	Connecting size	Packaging	Sales unit	Order no.
Male thread x male thread	1/4" x 1/4"	Self-service packaging	1	0901026130*
Male thread x male thread	3/8" x 3/8"	Self-service packaging	1	0901026149*
Male thread x male thread	1/2" x 1/2"	Self-service packaging	1	0901026157*
Male thread x male thread	1/4" x 1/4"	Loose	1	7806009185
Male thread x male thread	3/8" x 3/8"	Loose	1	7806034996
Male thread x male thread	1/2" x 1/2"	Loose	1	7806009207

Reducing double nipple



Version	Connecting size	Packaging	Sales unit	Order no.
Male thread x male thread	1/4" x 3/8"	Self-service packaging	1	0901026173*
Male thread x male thread	1/4" x 1/2"	Self-service packaging	1	0901026190*
Male thread x male thread	3/8" x 1/2"	Self-service packaging	1	0901026203*
Male thread x male thread	1/8" x 1/4"	Loose	1	7808009247

*Self-service packaging

Reducers



Version	Connecting size	Packaging	Sales unit	Order no.
Female thread x male thread	1/4" x 3/8"	Self-service packaging	1	0901026220*
Female thread x male thread	1/4" x 1/2"	Self-service packaging	1	0901026238*
Female thread x male thread	3/8" x 1/2"	Self-service packaging	1	0901026246*
Female thread x male thread	1/2" x 3/4"	Self-service packaging	1	0901026254*
Female thread x male thread	1/8" x 1/4"	Loose	1	7809009275
Female thread x male thread	1/4" x 3/8"	Loose	1	7809009283
Female thread x male thread	1/4" x 1/2"	Loose	1	7809035764
Female thread x male thread	3/8" x 1/2"	Loose	1	7809009291

Hose Nozzles



Hose nozzles with male thread
 ■ Brass hose nozzle

Version	Connecting size	Packaging	Sales unit	Order no.
Male thread x sleeve	1/4" x 6 mm	Self-service packaging	1	0901026041*
Male thread x sleeve	1/4" x 9 mm	Self-service packaging	1	0901026068*
Male thread x sleeve	3/8" x 6 mm	Self-service packaging	1	0901026050*
Male thread x sleeve	3/8" x 9 mm	Self-service packaging	1	0901026076*
Male thread x sleeve	1/4" x 6 mm	Loose	1	7805009343
Male thread x sleeve	3/8" x 6 mm	Loose	1	7805009351
Male thread x sleeve	1/4" x 9 mm	Loose	1	7805009440
Male thread x sleeve	3/8" x 9 mm	Loose	1	7805009483
Male thread x sleeve	1/4" x 13 mm	Loose	1	7805033767
Male thread x sleeve	1/2" x 13 mm	Loose	1	7805009300
Male thread x sleeve	3/8" x 13 mm	Loose	1	7805009319



Hose nozzles with female thread
 ■ Brass hose nozzle

Version	Connecting size	Packaging	Sales unit	Order no.
Female thread x sleeve	1/4" x 6 mm	Self-service packaging	1	0901026084*
Female thread x sleeve	1/4" x 9 mm	Self-service packaging	1	0901026092*
Female thread x sleeve	3/8" x 6 mm	Self-service packaging	1	0901026289*
Female thread x sleeve	3/8" x 9 mm	Self-service packaging	1	0901026106*
Female thread x sleeve	3/8" x 6 mm	Loose	1	7805009459
Female thread x sleeve	1/4" x 6 mm	Loose	1	7805009416
Female thread x sleeve	1/4" x 9 mm	Loose	1	7805009432
Female thread x sleeve	3/8" x 9 mm	Loose	1	7805009475

Hose connection sleeve



Version	Connecting size	Packaging	Sales unit	Order no.
Sleeve x sleeve	6 mm x 6 mm	Self-service packaging	1	0901026378*
Sleeve x sleeve	9 mm x 9 mm	Self-service packaging	1	0901026386*
Sleeve x sleeve	6 mm x 6 mm	Loose	1	7807009367
Sleeve x sleeve	9 mm x 9 mm	Loose	1	7807009375

Clamps

	From Ø mm	To Ø mm	Packaging	Sales unit	Order no.
Screw clamps					
					
	9,5	11,5	Self-service packaging	5	0901026777*
	12	20	Self-service packaging	5	0901026807*





	From Ø mm	To Ø mm	Packaging	Sales unit	Order no.
Hose clamps					
					
	11	13	Self-service packaging	5	0901054983*
	13	15	Self-service packaging	5	0901054991*

Fabric sealing tape

	Order no.
	0901026319*
Sealing tape for threads	
■ Seals without hemp or sealing paste	
■ For metal and plastic threaded joints	
Length on roll: 12 m	

Accessories for impact drivers and wrenches, ratchet screwdrivers

Socket wrench sets

	Order no.
 Socket wrench set 1/2" (10 pieces) Consisting of 10 socket wrenches (10, 11, 12, 13, 15, 17, 19, 21, 22, 24 mm)	628831000
 Socket wrench set 1/2" (3 pieces) Consisting of 3 socket wrenches (17, 19, 21 mm) For alloy wheel caps, long version	628833000
 Socket wrench extension 1/2" impact-proof Overall length 150 mm	628832000
 Socket wrench set 3/4" (8 pieces) Consisting of 8 socket wrenches (21, 22, 24, 26, 27, 28, 30, 32 mm)	628834000
 Socket wrench set 1" (8 pieces) Consisting of 8 socket wrenches (24, 27, 30, 32, 33, 34, 36, 38 mm) Deep version	628835000

Further accessories for impact drivers & wrenches



Magnetic wall bracket
Retention force 15 kg
Suitable for air tools, for 3/8", 1/2" and 3/4" air impact wrenches and accessories

628848000

Accessories for staplers and nailers

Staples



Type 90, back width 5.8 mm/wire thickness 1.05 x 1.27 mm
■ Treated with resin
■ Galvanized

Staple type	Width mm	Overall length mm	Sales unit	Suitable for	Order no.
Type 90	5,8	15	2.000	Kombi 32, Kombi 40/50, KG 90/25, KG 90/40	0901053790
Type 90	5,8	20	2.000	Kombi 32, Kombi 40/50, KG 90/25, KG 90/40	0901053804
Type 90	5,8	25	2.000	Kombi 32, Kombi 40/50, KG 90/25, KG 90/40	0901053812
Type 90	5,8	30	2.000	Kombi 32, Kombi 40/50, KG 90/40	0901053820
Type 90	5,8	35	2.000	Kombi 40/50, KG 90/40	0901053839
Type 90	5,8	40	2.000	Kombi 40/50, KG 90/40	0901053847



Type 80, back width 12.8 mm/wire thickness 0.65 x 0.95 mm
■ Treated with resin
■ Galvanized

Staple type	Width mm	Overall length mm	Sales unit	Suitable for	Order no.
Type 80	12,8	6	3.000	KG 80/16, DKG 80/16	0901053855
Type 80	12,8	8	3.000	KG 80/16, DKG 80/16	0901053863
Type 80	12,8	10	3.000	KG 80/16, DKG 80/16	0901053871
Type 80	12,8	12	3.000	KG 80/16, DKG 80/16	0901053880
Type 80	12,8	14	3.000	KG 80/16, DKG 80/16	0901053898
Type 80	12,8	16	3.000	KG 80/16, DKG 80/16	0901053901

Brad Nails



■ Galvanized
■ Wire thickness 0.9 x 1.2 mm

Nail type	Overall length mm	Sales unit	Suitable for	Order no.
Type SKN	16	1.000	Kombi 32, Kombi 40/50, SKN 50, DSN 50, DKNG 90/40	0901053715
Type SKN	20	1.000	Kombi 32, Kombi 40/50, SKN 50, DSN 50, DKNG 90/40	0901053723
Type SKN	25	1.000	Kombi 32, Kombi 40/50, SKN 50, DSN 50, DKNG 90/40	0901053731
Type SKN	30	1.000	Kombi 32, Kombi 40/50, SKN 50, DSN 50, DKNG 90/40	0901053740
Type SKN	35	1.000	Kombi 40/50, SKN 50, DSN 50, DKNG 90/40	0901053758
Type SKN	40	1.000	Kombi 40/50, SKN 50, DSN 50, DKNG 90/40	0901053766
Type SKN	45	1.000	Kombi 40/50, SKN 50, DSN 50, DKNG 90/40	0901053774
Type SKN	50	1.000	Kombi 40/50, SKN 50, DSN 50, DKNG 90/40	0901053782

Accessories for tyre inflation & pressure gauge



Adapter for bicycle valve
To inflate bicycle tyres with a tyre-inflator

Order no.
0901026262*



Adapter for ball hollow needle
To inflate balls with a tyre-inflator

0901031550*



Valve set, 3-piece
Consisting of bicycle valve adapter, ball adapter and adapter for air mattress

0901055769*



Lever connector with clip
Suitable for hose inside diameter 6 mm

7710672339



Connecting hose
(as spare); male thread: 1/4"

0901026661*



Connecting hose with lever connector
(as spare)

1001672319



Manometer Ø 80 mm (1-10 bar)
With protecting cap; calibrated; for RF 480

7823672327



Manometer tyre-inflator
(as spare); e.g. for RF 100

0901026815*

Accessories for paint spray guns



Nozzle kits for paint spray guns
■ Consisting of spray head, paint nozzle, colour needle and gasket. Nozzle kits for paint spray gun 600 HVLP/ LVLP without additional gasket.

Diameter mm	Suitable for	Order no.
1,2	FB 150, SB 200, FSP 600, FSP 1000 S	0901026858*
1,5	FB 150, SB 200, FSP 600, FSP 1000 S	0901026866*
2	FB 150, SB 200, FSP 600, FSP 1000 S	0901026882*
2,5	FB 150, SB 200, FSP 600, FSP 1000 S	0901026904*
1,3	FSP 600 HVLP	628807000*
1,5	FSP 600 HVLP	628808000*
1,8	FSP 600 HVLP	628809000*
2	FSP 600 HVLP	628810000*
1,3	FSP 600 LVLP	628811000*
1,5	FSP 600 LVLP	628812000*
1,8	FSP 600 LVLP	628813000*
2	FSP 600 LVLP	628814000*



Spare plastic gravity feed cup
suitable for: FSP 600 HVLP, FSP 600 LVLP

Order no.
628815000*









10 Spare filters FSP 600 HVLP / FSP 600 LVLP
■ Plastic paint sieve for flow bowl 6.28215 of the paint spray guns FSP 600 HVLP/ LVLP suitable for: FSP 600 HVLP, FSP 600 LVLP

628806000*

* Self-service packaging

Accessories for chipping hammers

	Order no.
 Stone chisel pointed Overall length: 173 mm; hexagonal shank bit SW 10	0901026521*
 Stone chisel flat 20 mm wide; overall length: 175 mm; hexagonal shank bit SW 10	0901026530*
 Stone chisel flat 50 mm wide; overall length: 180 mm; hexagonal shank bit SW 10	0901026548*
 Stone chisel flat 40 mm wide; overall length: 250 mm Hexagonal shank bit SW 10	0901026572*
 Spring for chipping hammer MHS 315 8 coils Suitable for MHS 315, DW 315	0901013047*
 Spring for chipping hammer MHS 450 10 coils Suitable for MHS 450, MHS 5050	0901026327*
 Needle scaler attachment Suitable for DMH 30 Set, DMH 290 Set, as well as all compressed air chipping hammers, universal	628822000

Accessories for large diameter saws

	Order no.
 Saw blades 14 teeth (10 pieces)	0901063087*
 Saw blades 24 teeth (10 pieces)	0901063095*
 Saw blades 32 teeth (10 pieces)	0901063109*



Accessories for die grinders

	Order no.
 Collet 8 mm for DG 700 / DG 700 L	628823000

Accessories for random orbital sander

	Order no.
 Spare sanding pad for ES 7700 / DSX 150	1319706247

Accessories for sand blasting guns

	Order no.
 Sand blasting abrasive <ul style="list-style-type: none"> ■ Grit 0.2 - 0.5 mm ■ Canister content 8 kg ■ Aluminium silicate glass melt 	0901064423
 Spare pipe for sand blasting gun	0901026408



General accessories for compressed air tools

	Order no.
 Special oil 0.5 litres for compressed air tools Mineral	0901008540

* Self-service packaging



Multi-adapter

- For connecting immersion pumps or domestic waterworks to discharge, suction or garden hoses

	Order no.
 Multi-adapter, 1" 1" Male x 1" nozzle x 3/4" Female x 3/4" nozzle	0903018410*
 Multi-adapter, 1 1/4" 1 1/4" Female x 1 1/2" nozzle x 1" Male x 1" nozzle Double nipple, 1 1/4" Male Thread	0903061677*
 Multi-adapter, 1 1/2" 1 1/2" Male x 2" nozzle x 1 1/4" Male x 1 1/2" nozzle	0903061685*





Angle connections with multi-adapter

- For connecting immersion pumps to quick-action couplings or discharge, suction or garden hoses

	Order no.
 Angle connection with multi-adapter 1 1/4" Angle connection: 1 1/4" male thread / 1 1/4" male thread Multi-adapter: 1 1/4" female thread, 1 1/4" nozzle, 1 1/4" male thread, 1" nozzle	0903064846*
 Angle connection with multi-adapter 1 1/2" Angle connection: 1 1/2" Male thread / 1 1/2" Male thread Multi-adapter: 1 1/2" female thread, 1 1/2" nozzle, 1 1/4" nozzle, 1" male thread	0903064854*

Angle connections





- For connecting immersion pumps to quick-action couplings or discharge, suction or garden hoses

	Order no.
 Angle connection, 1" 1" IG x 1" IG / 1 1/4" AG	0903019379*
 Angle connection 1 1/4" 1 1/4" AG x 1 1/4" AG / 1" IG	0903053143*
 Angle connection 1 1/2" stainless steel 1 1/2" IG / 1 1/2" AG	0903064838*
 Angle connection, 2" stainless steel 2" IG / 2" AG	628802000*



* Self-service packaging

Storz coupling

- For the connection of dirty water submersible pumps to discharge hoses with C-Storz coupling



	Order no.
 <p>Storz coupling, 1 1/2" C = 2" x 1 1/2" AG</p>	0903061375*
 <p>Storz coupling 1 1/2" with extension pipe 100 mm Consisting of: Storz coupling, C=2" x 1 1/2" female thread Pipe nipple, 1 1/2" Male Thread x 1 1/2" Male Thread - 100 mm Suitable for: DP 28-10 S Inox</p>	628801000
 <p>Storz coupling 1 1/2" with extension pipe 300 mm Consisting of: Storz coupling, C=2" x 1 1/2" female thread Pipe nipple, 1 1/2" Male Thread x 1 1/2" Male Thread - 300 mm Suitable for PS 17000 SN, PS 18000 SN</p>	0903019352
 <p>Storz coupling 2" C = 2" x 2" AG</p>	628800000*

Discharge set with fittings

	Order no.
 <p>Discharge set 7 m <ul style="list-style-type: none"> For the connection of all immersion pumps 1", 1 1/4" and 1 1/2" with multi-adaptor 1" Discharge hose, black, with incorporated rigid PVC coil, buckling-proof and non-abrasive Also suitable for suction devices (e.g. air, dust, woodchips) Consisting of: 1" Spiral hose Screwed hose connection 1 1/4" x 25 mm in brass Industrial stainless steel threaded hose clamp 20 - 32 mm Internal Ø: 25 mm Wall thickness: 2.5 mm Length: 7 m Operating pressure: 1.5 bar Bursting pressure: 5 bar Temperature resistance: -5 - 60 °C</p>	628821000
 <p>Discharge set: 15 m <ul style="list-style-type: none"> For connecting all immersion pumps with Storz couplings C=2" 2" Construction/industrial hose, high strength polyester thread, round woven, rubber-lined interior, corrosion-free, ozone-, decomposition- and mould-resistant Light alloy Storz couplings fixed in on both sides Couplings fixed in with special steel wire Consisting of: 2" Industrial hose Storz couplings C=2" Cam distance: 66 mm Internal Ø: 52 mm Wall thickness: 2.4 mm Length: 15 m Operating pressure: 10 bar Burst pressure: 30 bar Temperature resistance: 0° to 60°</p>	0903061294



Suction hoses

- For connection to the suction side of all garden pumps and domestic waterworks/ automatic domestic water systems with 1" female thread
- Suitable for drawing from wells, cisterns, ponds or streams
- 1" suction hose, transparent, with incorporated rigid PVC coil, buckling-proof and non-abrasive
- Check valve prevents water from flowing back for fast suction and pumping after interruption
- Strainer with shackle to attach a floating ball

	Order no.
 <p>Suction hose set 4m Consisting of: 1" Suction hose Hinge bolt clamp, galvanised steel Brass suction high pressure coupling, 1" nozzle Brass quick-action coupling, 1" male thread Brass hose nozzle/O-ring, 1" male thread Brass check valve, 1" female thread with strainer, special steel Internal Ø: 25 mm Wall thickness: 2.5 mm Bending radius: 110 mm Length: 4 m Operating pressure: 2.5 bar Bursting pressure: 7 bar Temperature resistance: -5 - 60 °C Water column (vacuum): 6 m</p>	628797000
 <p>Suction hose set 7m Consisting of: 1" Suction hose Hinge bolt clamp, galvanised steel Brass suction high pressure coupling, 1" nozzle Brass quick-action coupling, 1" male thread Brass hose nozzle/O-ring, 1" male thread Brass check valve, 1" female thread with strainer, special steel Internal Ø: 25 mm Wall thickness: 2.5 mm Bending radius: 110 mm Length: 7 m Operating pressure: 2.5 bar Bursting pressure: 7 bar Temperature resistance: -5 - 60 °C Water column (vacuum): 6 m</p>	628798000

Floating intake

- Suitable for drawing from cisterns, ponds or streams
- Prevents the suction of dirt particles
- Water intake in the cleanest area, just below the water surface



	Order no.
 <p>Floating ball For connection to standard and professional suction hose sets Floating ball PE / 2 eyelets, Ø 150 mm Special steel ring, VA</p>	0903061367
 <p>Floating intake For connection to 1" spiral suction hoses Consisting of: Floating ball PE / 2 eyelets, Ø 150 mm Special steel ring, VA Hose clamp, steel galvanised Brass hose nozzle/O-ring, 1" male thread Brass check valve, 1" with strainer, special steel</p>	0903061359

* Self-service packaging

Pump assembly set



Pump assembly set MSS suction connector

- All in one package with illustrated assembly instructions
- Filter to protect the pump and sprinkling systems from damage caused by sand and dirt particles, 28 bar burst pressure
- Return valve: prevents the water flowing back into wells or cisterns
- Ball valve (closed): prevents the water flowing back into wells or into the suction area during maintenance jobs, e.g. filter cleaning or pump disassembly
- Quick-action coupling as connection option for suction hose sets
- Seal strip: seals without hemp or sealing paste

	Order no.
 <p>Pump assembly set MSS 310 – HWA/ P</p> <ul style="list-style-type: none"> ■ For mounting to the suction connector of all garden pumps and domestic water / automatic domestic water systems with 1" female thread ■ Garden pumps and domestic water works automatic domestic water systems require a short filter due to their lower construction height <p>Manufactured length approx. 310 mm</p> <p>Consisting of: Filter for garden pumps, short, 1" brass female thread Washable filter insert, 80 my Brass double nipple, 1" Male Thread x 1" Male Thread Brass check valve, 1" female thread x 1" female thread Nickel-plated brass ball valve, 1" female thread x 1" female thread Brass quick-action coupling, 1" male thread Fabric sealing tape, 12 m roll Filter key for loosening the filter dome</p>	0903061260
 <p>Pump assembly set MSS 380 – HWW</p> <ul style="list-style-type: none"> ■ For mounting to the suction connector of all domestic water works with 1" female thread <p>Manufactured length approx. 380 mm</p> <p>Consisting of: Filter for domestic waterworks, long, 1" brass female thread Washable filter insert, 80 my Brass double nipple, 1" Male Thread x 1" Male Thread Brass check valve, 1" female thread x 1" female thread Nickel-plated brass ball valve, 1" female thread x 1" female thread Brass quick-action coupling, 1" male thread Zinc-plated pipe nipple, 1" Male Thread x 1" Male Thread x 100 mm Fabric sealing tape, 12 m roll Filter key for loosening the filter dome</p>	0903061278

Pump assembly set MSD discharge port

- All in one package with illustrated assembly instructions
- Ball drain cock with nozzle: connection option for a 3/4" garden hose
- Tap connector: alternative connection option of a system quick-action coupling
- Seal strip: seals without hemp or sealing paste

	Order no.
 <p>Pump assembly set MSD 200 – HWW/P</p> <ul style="list-style-type: none"> ■ For mounting on the discharge port of all garden pumps and domestic water works with 1" female thread ■ With protective cap for the easy filling of the pump body with water (e.g. watering can) <p>Manufactured length approx. 200 mm</p> <p>Consisting of: Zinc-plated pipe nipple, 1" Male Thread x 1" Male Thread x 100 mm Zinc-plated T-piece, 1" female thread x 3/4" female thread x 1" female thread Brass, nickel-plated ball drain cock, 3/4" female thread x 1" male thread x 3/4" nozzle Cock connector, 1" female thread Brass quick-action coupling, 1" male thread Quick-action coupling, brass protective cap Fabric sealing tape, 12 m roll</p>	0903061251
 <p>Pump assembly set MSD 1000 – HWA</p> <ul style="list-style-type: none"> ■ For mounting to the discharge port of all domestic waterworks with 1" Male Thread ■ Wall mounting prevents leverage force from the water tap to the automatic domestic system <p>Pressure hose for flexible connection, 8 bar operating pressure, 24 bar burst pressure Manufactured length approx. 1,000 mm</p> <p>Consisting of: Pressure hose, 1 m x 3/4" Steel galvanised chuck jaw clamps, 23-25 mm Brass angle hose connector 1" female thread x 3/4" nozzle Hose nozzle with brass O-ring 3/4" Male Thread x 3/4" nozzle Brass wall disc 3/4" female thread x 3/4" female thread Brass, nickel-plated ball drain cock, 3/4" female thread x 1" male thread x 3/4" nozzle Cock connector, 1" female thread Fabric sealing tape, 12 m roll</p>	0903061243

Check valves

- For connecting to the suction pipe of all garden pumps and domestic waterworks /automatic domestic water systems
- Ensures smooth operation and short restart times in case of repeated starts
- Prevents the pump from running dry when switched off







	Order no.
 <p>Brass check valve 1" Connecting thread: 1" male thread x 1" female thread</p>	628803000*
 <p>Brass check valve, 1 1/4" Connecting thread: 1 1/4" male thread / x 1 1/4" female thread</p>	628805000*

* Self-service packaging

17
18
19
20
21
22
23
24
25
26
27
28
29
30
31
32

Filters for garden pumps and domestic waterworks/automatic domestic water systems



- For connecting to the suction pipe of all garden pumps and domestic waterworks /automatic domestic water systems
- Garden pumps and domestic water works automatic domestic water systems require a short filter due to their lower construction height
- The filter protects the pump and sprinkling systems from damage by sand and dirt particles
- Housing and lid made from impact-resistant polypropylene
- Connections with brass female thread
- Temperature resistant from 0 to 60°C

	Order no.
 <p>Filter 1" short Height: 190 mm Diameter: 120 mm Water throughput: 6,200 l/hour Burst pressure: 28 bar Operating pressure: 8 bar</p>	0903016450
 <p>Filter 1" short, with washable filter insert ■ Delivery includes washable filter insert with nylon fabric 80 my, protects against ultra-fine sand and solid matter Height: 190 mm Diameter: 120 mm Water throughput: 6,200 l/hour Burst pressure: 28 bar Operating pressure: 8 bar</p>	0903050314
 <p>Filter 1 1/4" short, with washable filter insert ■ Delivery includes washable filter insert with nylon fabric 80 my, protects against ultra-fine sand and solid matter Height: 190 mm Diameter: 120 mm Water throughput: 6,200 l/hour Burst pressure: 28 bar Operating pressure: 8 bar</p>	628816000
 <p>Filter 1" long Height: 310 mm Diameter: 120 mm Water throughput: 6,400 l/hour Burst pressure: 28 bar Operating pressure: 8 bar</p>	0903009250
 <p>Filter 1" long, with washable filter insert ■ Delivery includes washable filter insert with nylon fabric 80 my, protects against ultra-fine sand and solid matter Height: 310 mm Diameter: 120 mm Water throughput: 6,400 l/hour Burst pressure: 28 bar Operating pressure: 8 bar</p>	0903050306
 <p>Filter 1 1/4" long, with washable filter insert ■ Delivery includes washable filter insert with nylon fabric 80 my, protects against ultra-fine sand and solid matter Height: 310 mm Diameter: 120 mm Water throughput: 6,400 l/hour Burst pressure: 28 bar Operating pressure: 8 bar</p>	628817000
 <p>Filter 1 1/2" long Height: 310 mm Diameter: 120 mm Water throughput: 13,800 l/hour Burst pressure: 28 bar Operating pressure: 8 bar</p>	0903014253

Filter inserts





One-way filter insert

- Insert with twisted thread, 20 my
- Protects pump and sprinkling systems against damage by very fine sand and solid matter



	Connecting thread	Version	Order no.
	1"	Short	0903028432*
	1"	Long	0903028351*

Washable filter insert

- Washable insert with nylon fabric, 80 my
- Protects pump and sprinkling systems against damage by sand and solid matter



	Connecting thread	Version	Order no.
	1"	Short	0903028440*
	1 1/4"	Short	628818000*
	1"	Long	0903028360*
	1 1/4" + 1 1/2"	Long	0903028416*
	1"	Long	628804000*

Filter accessories

	Order no.
 <p>Filter key ■ For the loosening of the filter dome Internal Ø, 120 mm</p>	0903058005*
 <p>Filter sealing set Suitable for 1" and 1 1/2" filters Consisting of: 1x Filter dome O-ring, Ø 88 x 3.5 mm 1x Filter insert flat seal, Ø 52 x 40 x 4 mm 2x Filter insert flat seal, Ø 52 x 27 x 4 mm</p>	0903061316*

* Self-service packaging

Dry-run protection



	Order no.
 <p>HM 3 - Electronic pressure switch with dry-run protection</p> <ul style="list-style-type: none"> Automatic control: switch on the pump for water discharge and switch off upon reaching the maximum pressure Dry-run protection: automatic deactivation of the motor when nothing is left to pump (leaky suction pipe, the water supply dries out) LED display to check the operating condition Membrane and spring to eliminate the impact of pressure surges Safety valve to prevent water leaking if the diaphragm is damaged Quick and easy assembly Ideal for converting a garden pump into an automatic domestic water system Also suitable for deep well pumps and submersible pressure pumps <p>Switch-on pressure approx. 1.5 bar Voltage: 115 V/ 230 V Frequency: 50 / 60 Hz Protection type: IP 65 Maximum amperage: 16(8) A-1.5 kW Maximum operating pressure 10 bar Maximum operating temperature 0° to 60° C Connection: Discharge port, 1" male thread Device connection, 1" male thread Brass adapter 1" female thread x 1" male thread</p>	628799000
 <p>Dry-run protection stop switch</p> <ul style="list-style-type: none"> Dry-run protection for domestic waterworks, automatic domestic water systems, garden pumps, submersible pumps and submersible pressure pumps Float switch with 10 metre cable length When drawing from cisterns, ponds or streams, the float switch switches the pumps on and off automatically depending on the water level Plug/socket combination 	0903028521

Armoured hose

	Order no.
 <p>Armoured hose</p> <ul style="list-style-type: none"> For connection to the suction/discharge side of all domestic waterworks /automatic domestic water systems with 1" male thread/female thread on permanently mounted pipes Absorbs running noises and guarantees high safety by means of double deep injection on the connection fittings Special steel jacket 1", interior latex core Rust-free fittings <p>Consisting of: Armoured hose, 1" male thread x 1" female thread Gasket Ø 30 x 23 x 3 mm</p> <p>Internal Ø: 25 mm Wall thickness: 4 mm Length 500 mm Operating pressure: 6 bar Bursting pressure: 18 bar Temperature resistance: 0° to 65°</p>	0903061340*

Garden showers

- Multi-functional for cleaning and irrigation
- Sturdy metal version with disc handle and locking device
- Brass connection - compatible with all commercial plug-in systems
- Infinitely adjustable water volume via a separate rotating knob
- Water jet can be adjusted from a hard full jet to fine atomised spray
- Soft plastic ring on sprinkler head for protection against damage
- Hand valve with locking device

	Order no.
 <p>Shower spray SB 2</p> <ul style="list-style-type: none"> Water jet infinitely adjustable from full hard jet to fine spray 	0903063122*
 <p>Garden shower GB 7</p> <ul style="list-style-type: none"> 7 Water jet shapes from full spray to fine atomised spray 	0903060778*
 <p>Spray lance GS 10</p> <ul style="list-style-type: none"> 10 Water jet formats ranging from full spray to fine atomised spray Long reach, e.g. saves you having to step over beds Ideal for watering hanging flower arrangements <p>Length: 920 mm</p>	0903063130*

Garden sprinklers

	Order no.
 <p>Surface sprinkler FR 9</p> <ul style="list-style-type: none"> Sturdy metal version for mobile and stationary use Removable dirt filter to protect the sprinkler from damage by sand and dirt particles Brass coupling plug, compatible with all commercial plug-in systems Multi-functional for watering surfaces or small front gardens 9 Sprinkler areas, from circle to rectangle to atomised spray Desired sprinkler area adjustable by turning the sprinkler disc <p>Sprinkler surfaces: Circle Ø = maximum 10 m / 80 m² Semi-circle r = maximum 8 m / 100 m² Square maximum 8 x 8 m / 64 m² Rectangle maximum 16 x 2 m / 32 m²</p> <p>Connection: Brass cap nut, 3/4" female thread Brass coupling plug 3/4" male thread</p>	0903063149

Sealing tape for threads





	Order no.
 <p>Sealing tape for threads</p> <ul style="list-style-type: none"> Seals without hemp or sealing paste For metal and plastic threaded joints <p>Length on roll: 12 m Width: 12 mm Thickness: 0.1 mm</p>	0901026319*

Bit boxes





- Different high-quality bit sets in a robust box with transparent cover for good overview
- Easy removal
- Bits in S2 quality steel with colour coding for quick finding



Sample sales display

			Sales unit / sales display	Order no.
NEW		S2 bits, L = 25 mm (30 piece): ⊕ PH1, PH2x2, PH3 ⊗ PZ1, PZ2x2, PZ3 ⊖ SL3, SL4, SL5, SL6 ○ H3, H4, H5, H6 ⊙ T10, T15, T20, T25, T27, T30, T40 ⊕ T10, T15, T20, T25, T27, T30, T40	1 x adapter 1 x magnetic quick-change bit holder 65 mm	1 piece / 12 pieces 626696000
		S2 bits, L = 25 mm (8 pieces): ⊕ PH1, PH2 ⊗ PZ1, PZ2 ⊖ SL5,5 ○ H4 ⊙ T20, T25 1 x magnetic bit holder		1 piece / 21 pieces 630419000
NEW		S 2 bits L= 25 mm (14 pieces): ⊕ PH1, PH2 ⊗ PZ1, PZ2 ⊖ SL4, SL6 ○ H3, H4, H5 ⊙ T10, T15, T20, T25, T30 1 x magnetic quick-change bit holder		1 piece / 24 pieces 626703000
NEW		S 2-bits L= 25 mm (18 pieces): ⊕ PH1, PH2, PH3 ⊗ PZ1, PZ2, PZ3 ⊖ SL4, SL5,5, SL6,5 ○ H3, H4, H5, H6 ⊙ T10, T15, T20, T25, T30	Socket wrench (6 pcs): 1/4", 6 mm, 7 mm, 8 mm, 10 mm, 13 mm 1 x extension 1 x ratchet	1 piece / 12 pieces 626701000
NEW		S 2-bits L= 25 mm (21 pieces): ⊕ PH1x1, PH2x2, PH3x1 ⊗ PZ1x1, PZ2x2, PZ3x1 ⊖ SL3x1, SL5x1 ○ H3x1, H4x1, H5x1, H6x1 ⊙ T10x1, T15x1, T20x2, T25x1, T30x1, T40x1	L = 50 mm (6 pieces): ⊕ PH2x1 ⊗ PZ2x1 ⊖ T20x1, T25x1 ○ SL4,5x1 ⊙ H4x1 1 x adapter 1 x magnetic quick-change bit holder	1 piece / 12 pieces 626710000

			Sales unit / sales display	Order no.
NEW		S 2-bits L= 25 mm (21 pieces): ⊕ PH1x1, PH2x2, PH3x1 ⊗ PZ1x1, PZ2x2, PZ3x1 ⊖ SL3x1, SL5x1 ○ H3x1, H4x1, H5x1, H6x1 ⊙ T10x1, T15x1, T20x2, T25x1, T30x1, T40x1	L = 50 mm (6 pieces): ⊕ PH2x1 ⊗ PZ2x1 ⊖ T20x1, T25x1 ○ SL4,5x1 ⊙ H4x1 1 x adapter 1 x magnetic quick-change bit holder 1 x Mini flash light	1 piece / 12 pieces 626721000
NEW		S2 bits, L = 25 mm (30 piece): ⊕ PH1, PH2x2, PH3 ⊗ PZ1, PZ2x2, PZ3 ⊖ SL3, SL4, SL5, SL6 ○ H3, H4, H5, H6 ⊙ T10, T15, T20, T25, T27, T30, T40 ⊕ T10, T15, T20, T25, T27, T30, T40	1 x adapter 1 x magnetic quick-change bit holder 65 mm	1 piece / 12 pieces 626700000
NEW		S2 bits, L = 25 mm ⊕ T10x3, T15x3, T20x6, ⊙ T25x6, T27x3, T30x6, T40x4 1 x Magnetic bit holder 65 mm		1 piece / 12 pieces 626709000
NEW		S2 bits, L = 25 mm (48 pieces): ⊕ PH1, PH2x3, PH3x3 ⊗ PZ1, PZ2x3, PZ3x3 ⊖ SL4x2, SL5x2, SL6x2 ○ H3, H4, H5 ⊙ T10x2, T15x2, T20x2, T25x2, T27x2, T30x2, T40x2, ⊕ T10, T15, T20, T25, T27, T30, T40	L = 70 mm (7 pieces): ⊕ PH2, PH3 ⊗ PZ1, PZ2 ⊖ SL6 ○ T20, T25 1 x magnetic quick-change bit holder	1 piece / 12 pieces 626702000
NEW		S2-Bits, L = 25 mm (60 pieces): ⊕ PH1x3, PH2x6, PH3x3 ⊗ PZ1x3, PZ2x6, PZ3x3 ⊖ SL4x3, SL6x3 ○ H4x3, H5x3, H6x3 ⊙ T10x3, T15x3, T20x3, T25x3, T27x3, T30x3, T40x3	L = 70 mm (9 pieces): ⊕ PH1, PH2, PH3 ⊗ PZ1, PZ2 ⊖ SL4, SL6 ○ T20, T25 1 x magnetic quick-change bit holder 1 x magnetic bit holder	1 piece / 6 pieces 626704000
		S2 bits, L = 25 mm (25 pieces): ⊗ PZ2		1 piece / 12 pieces 626711000



Bit box PH2, 25 pieces	Sales unit / sales display	Order no.
NEW  S2 bits, L = 25 mm (25 pieces): ⊕ PH2	1 piece / 12 pieces	626715000
Bit box T20, 25 pieces	Sales unit / sales display	Order no.
 S2 bits, L = 25 mm (25 pieces): ⊕ T20	1 piece / 12 pieces	626712000
Bit box T25, 25 pieces	Sales unit / sales display	Order no.
 S2 bits, L = 25 mm (25 pieces): ⊕ T25	1 piece / 12 pieces	626713000
Bit box T30, 25 pieces	Sales unit / sales display	Order no.
NEW  S2 bits, L = 25 mm (25 pieces): ⊕ T30	1 piece / 12 pieces	626716000
Bit box T40, 25 pieces	Sales unit / sales display	Order no.
NEW  S2 bits, L = 25 mm (25 pieces): ⊕ T40	1 piece / 12 pieces	626717000

Bit roll-up case

- Bits in S2 quality steel
- Bits with colour coding for fast finding
- Robust textile bag
- Ergonomic screwdriver handle



Sample sales display

Bit roll-up case, 7 pieces	Sales unit / sales display	Order no.
 S2 bits, L = 89 mm (6 pieces): ⊕ PH2 ⊕ PZ1, PZ2 ⊖ SL5,5 ⊖ T20, T25	1 x Screwdriver handle 1 piece / 12 pieces	626723000
Bit roll-up case, 30 pieces	Sales unit / sales display	Order no.
 S2 bits, L = 25 mm (16 pieces): ⊕ PH1, PH2x2, PH3 ⊕ PZ1, PZ2x2, PZ3 ⊖ SL3, SL5,5 ⊖ T15, T20 x 2, T25 x 2, T30 L = 50 mm (7 pieces): ⊕ PH2 ⊕ PZ1, PZ2 ⊖ SL3 ⊖ T20, T25 ⊖ H4	L = 89 mm (6 pieces): ⊕ PH2 ⊕ PZ1, PZ2 ⊖ SL5,5 ⊖ T20, T25 1 x Screwdriver handle	1 piece / 12 pieces 626726000

Masonry drill bit box

- Carbide masonry drill bit for drills and impact drills, milled version
- Suitable for drilling in bricks, masonry, natural stone etc.
- Robust box with transparent cover

Masonry drill bit box, 8 pieces	Sales unit / sales display	Order no.
NEW  ⌀ 3 mm, ⌀ 4 mm, ⌀ 5 mm, ⌀ 5,5 mm, ⌀ 6 mm, ⌀ 7 mm, ⌀ 8 mm, ⌀ 10 mm	1 piece / 12 pieces	626706000

Wood drill bit box

- Wood spiral drill bit made of high-grade chrome vanadium steel, hardened
- With centering point for use in hard and soft wood, plywood, chipboards, etc.
- Robust box with transparent cover

Wood drill bit box, 8 pieces	Sales unit / sales display	Order no.
NEW  ⌀ 3 mm, ⌀ 4 mm, ⌀ 5 mm, ⌀ 5,5 mm, ⌀ 6 mm, ⌀ 7 mm, ⌀ 8 mm, ⌀ 10 mm	1 piece / 12 pieces	626705000

Accessory sets

- Different high-quality accessory sets in a robust box with transparent cover for good overview
- Easy removal
- Bits in S2 quality steel with colour coding for quick finding



Sample sales display

Accessory set, 35 pieces	Sales unit / sales display	Order no.
<p>NEW</p>  <p>HSS-G metal drill bits (6 pieces): Ø 3 mm, Ø 4 mm, Ø 5 mm, Ø 6 mm, Ø 8 mm, Ø 10 mm Wood drill bits (6 pieces): Ø 3 mm, Ø 4 mm, Ø 5 mm, Ø 6 mm, Ø 8 mm, Ø 10 mm</p> <p>S2 bits, L = 25 mm (16 pieces): PH1, PH2x2, PH3 PZ1, PZ2x2, PZ3 SL3, SL5,5 T15, T20 x 2, T25 x 2, T30 L = 89 mm (6 pieces): PH2 PZ1, PZ2 SL5,5 T20, T25 1 x magnetic bit holder</p>	1 piece / 6 pieces	626725000

Accessory set, 55 pieces	Sales unit / sales display	Order no.
<p>NEW</p>  <p>HSS-TiN metal drill bits (14 pieces): Ø 1,5 mm x 2; Ø 2 mm x 2; Ø 2,5 mm; Ø 3 mm x 2; Ø 3,5 mm; Ø 4 mm; Ø 4,5 mm; Ø 5 mm; Ø 5,5 mm; Ø 6 mm; Ø 6,5 mm Carbide masonry drill bit (7 pieces): Ø 4 mm; Ø 5 mm; Ø 6 mm x 2; Ø 7 mm; Ø 8 mm; Ø 10 mm CV wood drill bit (5 pieces): Ø 4 mm, Ø 5 mm, Ø 6 mm, Ø 8 mm, Ø 10 mm Flat wood drill bit (2 pieces): Ø 16 mm; Ø 22 mm</p> <p>S 2-bits L= 25 mm (18 pieces): PH1, PH2 x 2, PH3 PZ1, PZ2 x 2, PZ3 SL4, SL6, SL7 H3, H4, H5, H6 T15, T20, T25 Socket wrench (4 pieces): 7 mm, 8 mm, 9 mm, 10 mm 1 x template 1 x wallpaper trimming knife 1 x magnetic bit holder 1 x countersink 1 x socket spanner adapter</p>	1 piece / 6 pieces	626707000

Accessory set, 86 pieces	Sales unit / sales display	Order no.
<p>NEW</p>  <p>HSS-TiN metal drill bit (14 pieces): Ø 1,5 mm x 2; Ø 2 mm x 2; Ø 2,5 mm; Ø 3 mm x 2; Ø 3,5 mm; Ø 4 mm; Ø 4,5 mm; Ø 5 mm; Ø 5,5 mm; Ø 6 mm; Ø 6,5 mm Carbide masonry drill bit (7 pieces): Ø 4 mm; Ø 5 mm; Ø 6 mm x 2; Ø 7 mm; Ø 8 mm; Ø 10 mm CV wood drill bit (5 pieces): Ø 4 mm, Ø 5 mm, Ø 6 mm, Ø 8 mm, Ø 10 mm Flat wood drill bit (4 pieces): Ø 12 mm, Ø 16 mm, Ø 19 mm, Ø 25 mm</p> <p>S2-Bits, L = 25 mm (32 pieces): PH0, PH1 x 2, PH2 x 2, PH3 x 2 PZ0, PZ1 x 2, PZ2 x 2, PZ3 x 2 SL3, SL4 x 2, SL6 x 2, SL7 H3, H4, H5 x 2, H6 T10, T15 x 2, T20 x 2, T25, T30 L = 50 mm (13 pieces): PH1, PH2x2, PH3 PZ1, PZ2x2, PZ3 T15, T20x2, T25, T30 Socket wrenches (8 pieces) 5 mm, 6 mm, 7 mm, 8 mm, 9 mm, 10 mm, 11 mm, 12 mm 1 x countersink (wood) 1 x magnetic bit holder 1 x Ø ruler</p>	1 piece / 6 pieces	626708000

Drill bit assortment

- Metal drill bit HSS-G, suitable for drilling in steel and cast steel, alloyed and non-alloyed, NF metals etc.
- Wood spiral drill bit made of high-grade chrome vanadium steel, hardened for use in hard and soft wood, plywood, chipboards, etc.
- Carbide masonry drill bit for drills and impact drills, milled version for drilling bricks, masonry, etc.



Sample sales display

Drill bit assortment, 13 pieces	Sales unit / sales display	Order no.
<p>NEW</p>  <p>Metal drill bit HSS-G (5 pieces): 1 x Ø 4 x 62 mm, 2 x Ø 5 x 75 mm, 1 x Ø 6 x 92 mm, 1 x Ø 8 x 117 mm</p> <p>Masonry drill bit (4 pieces): 1 x Ø 4 x 75 mm, 1 x Ø 5 x 85 mm, 1 x Ø 6 x 100 mm, 1 x Ø 8 x 120 mm</p> <p>Wood drill bit (4 pieces): 1 x Ø 4 x 74 mm, 1 x Ø 5 x 85 mm, 1 x Ø 6 x 92 mm, 1 x Ø 8 x 117 mm</p>	1 piece / 12 pieces	626728000

Drill bit assortment roll-up case, 20 pieces	Sales unit / sales display	Order no.
 <p>Metal drill bit HSS-G (8 pieces): 2 x Ø 3 x 62 mm, 2 x Ø 4 x 62 mm, 1 x Ø 5 x 75 mm, 1 x Ø 6 x 92 mm, 1 x Ø 8 x 117 mm, 1 x Ø 10 x 135 mm</p> <p>Masonry drill bit (6 pieces): 1 x Ø 3 x 60 mm, 1 x Ø 4 x 75 mm, 1 x Ø 5 x 85 mm, 1 x Ø 6 x 100 mm, 1 x Ø 8 x 120 mm, 1 x Ø 10 x 120 mm</p> <p>Wood drill bits (6 pieces): 1 x Ø 3 x 62 mm, 1 x Ø 4 x 74 mm, 1 x Ø 5 x 85 mm, 1 x Ø 6 x 92 mm, 1 x Ø 8 x 117 mm, 1 x Ø 10 x 133 mm</p>	1 piece / 9 pieces	626729000

SDS-plus drill/chisel bits

- For general chiselling and demolition work of masonry, concrete and loose stones.
- SDS-plus drill bit with high-quality carbide drill tip
- Good drilling output with good tool life
- For use in concrete, masonry, and natural stone



Sample sales display

SDS-plus chisel set, 2 pieces	Sales unit / sales display	Order no.
 <p>1 x pointed chisel, L = 200 mm 1 x flat chisel 20 x 200 mm</p>	1 piece / 6 pieces	630486000

SDS-plus drill bit / chisel set, "SP", 17 pieces	Sales unit	Order no.
<p>NEW</p>  <p>Ø 5, 6, 8, 10 L = 110 mm Ø 6, 8, 10, 12 L = 160 mm Ø 8, 10 L = 210 mm Ø 12, 14 L = 260 mm Pointed chisel, L = 140 mm, L = 250 mm Flat chisel 20x140mm, 20x250mm Scaling chisel 40x250mm</p>	1 piece	628414000

SDS-plus storage case, 4 pieces	Sales unit / sales display	Order no.
 <p>Ø 5, 6, 8, 10 mm Length: 160 cm</p>	1 piece / 10 pieces	625580000

SDS-plus classic drill bit / chiselling bit set, 10 pieces	Sales unit / sales display	Order no.
 <p>Ø 5, 5.5, 6, 7, 8 = 160 mm Ø 10, 12, 14 = 210 mm Length: 160mm, 210 mm Pointed chisel, L = 250 mm Flat chisel, Ø 20 x 250 mm</p>	1 piece / 10 pieces	630824000

SDS-max drill/chisel bits

- For general chiselling and demolition work of masonry, concrete and loose stones.
- SDS-max drill bit with high-quality carbide drill tip
- Good drilling output with good tool life
- For use in concrete, masonry, and natural stone



Sample sales display

SDS-max chisel set, 2 pieces	Sales unit / sales display	Order no.
 <p>1 x pointed chisel, L = 360 mm 1 x flat chisel 25 x 360 mm</p>	1 piece / 6 pieces	623309000



SDS-max drill bit / chisel set, 7 pieces	Sales unit	Order no.
 <p>NEW Ø 16, 20, 22, 25 L = 540 mm Pointed chisel L = 400m Flat chisel 25 x 400mm 2x</p>	1 piece	623106000



HSS drill bit storage case

- Metal drill bit, HSS
- Suitable for bores in steel, NF metals, cast steel
- Drill bit set in high-quality metal or plastic cassette





Sample sales display

HSS-R drill bit storage case	Diameter x bore	Version	Sales unit / sales display	Order no.
	1-10 x 0,5 mm	19 pieces	1 piece / 6 pieces	627151000
	1-13 x 0,5 mm	25 pieces	1 piece / 4 pieces	627152000
	1-10 x 0,5 mm	19 pieces NEW	1 piece / 6 pieces	627666000
	1-13 x 0,5 mm	25 pieces NEW	1 piece / 4 pieces	627667000

HSS-G drill bit storage case	Diameter x bore	Version	Sales unit / sales display	Order no.
	1-10 x 0,5 mm	19 pieces	1 piece / 6 pieces	627153000
	1-13 x 0,5 mm	25 pieces	1 piece / 4 pieces	627154000
	1-10 x 0,5 mm	19 pieces NEW	1 piece / 6 pieces	627668000
	1-13 x 0,5 mm	25 pieces NEW	1 piece / 4 pieces	627669000

HSS-TiN drill bit storage case	Diameter x bore	Version	Sales unit / sales display	Order no.
	1-10 x 0,5 mm	19 pieces	1 piece / 6 pieces	627156000
	1-10 x 0,5 mm	19 pieces NEW	1 piece / 6 pieces	627670000

HSS-CO drill bit storage case	Diameter x bore	Version	Sales unit / sales display	Order no.
	1-10 x 0,5 mm	19 pieces	1 piece / 6 pieces	627157000
	1-10 x 0,5 mm	19 pieces NEW	1 piece / 6 pieces	627671000
	1-13 x 0,5 mm	25 pieces NEW	1 piece / 4 pieces	627672000

Geared chuck with SDS-plus adapter

- For use on rotary hammers with SDS plus holder
- For clamping of straight shank drills, tools with straight shaft



Sample sales display

Geared chuck with SDS-plus adapter	Sales unit / sales display	Order no.
 <p>1.5 - 13 mm 1/2" - 20 UNF SDS-plus adapter with 1/2" - 20 UNF male thread Chuck keys</p>	1 piece / 6 pieces	626724000

Cutting discs Inox

- Universal disc for processing steels/stainless steels
- Good cutting performance with good tool life.
- Low material consumption, power-saving, low machine load.
- Low in iron, sulphur and chlorine (Fe + S + Cl ≤ 0.1 %)



Sample sales display

Cutting discs Inox, TF 41, in tin	Quality class	Diameter x thickness x bore	Version	Maximum speed	Sales unit / sales display	Order no.
	A 60 R	115 x 1 x 22,23 mm	Straight	13.200 /min	1 / 10 pieces	616358000
	A 60 R	125 x 1 x 22,23 mm	Straight	13.200 /min	1 / 10 pieces	616359000

Diamond cutting discs »SP« / SP-U

- Universal diamond cutting disc with segmented edge for aggressive, fast cutting with high cutting performance and good tool life
- Well suited for all construction/building materials such as concrete, exposed aggregate concrete, hard sandstone and clay tiles.
- Segment height 10 mm
- Delivery in counter display when ordering 10 pieces (except for blister packaging)



Sample sales display

Diameter x bore	Segment height	Maximum speed	Sales unit / sales display	Packaging	Order no.
115 x 22,23 mm	10 mm	13.300 /min	1 piece / 10 pieces	Blister	624295000
115 x 22,23 mm	10 mm	12.200 /min	1 piece / 10 pieces	Blister	624296000
230 x 22,23 mm	10 mm	6.600 /min	1 piece / 10 pieces	Blister	624298000
115 x 22,23 mm	10 mm	13.300 /min	1 piece / 10 pieces	Cardboard box	624306000
125 x 22,23 mm	10 mm	12.200 /min	1 piece / 10 pieces	Cardboard box	624307000
150 x 22,23 mm	10 mm	10.200 /min	1 piece / 10 pieces	Cardboard box	624308000
180 x 22,23 mm	10 mm	8.500 /min	1 piece / 10 pieces	Cardboard box	624309000
230 x 22,23 mm	10 mm	6.600 /min	1 piece / 10 pieces	Cardboard box	624310000



NEW

Diamond cutting discs »SP« / SP-UT

- Universal diamond cutting disc with closed edge for comfortable cutting with high cutting performance and good tool life
- Well suited for all construction/building materials such as concrete, exposed aggregate concrete, hard sandstone and clay tiles.
- Clean cutting edges without material chipping
- Segment height 10 mm



Sample sales display



NEW

Diameter x bore	Segment height	Maximum speed	Sales unit / sales display	Order no.
115 x 22,23 mm	10 mm	13.300 /min	1 piece / 10 pieces	628551000
125 x 22,23 mm	10 mm	12.200 /min	1 piece / 10 pieces	628552000
180 x 22,23 mm	10 mm	8.500 /min	1 piece / 10 pieces	628553000
230 x 22,23 mm	10 mm	6.600 /min	1 piece / 10 pieces	628554000

Diamond cutting discs »SP« / SP-T

- Standard diamond cutting disc with closed edge for cutting without chipped edges on workpieces with high-quality surfaces such as tiles, natural stone slabs
- High cutting output and good tool life
- Segment height 7 mm



Sample sales display

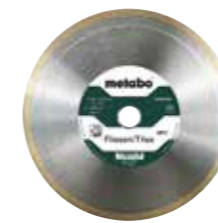

NEW

Diameter x bore	Segment height	Maximum speed	Sales unit / sales display	Order no.
115 x 22,23 mm	7 mm	13.300 /min	1 piece / 10 pieces	628555000
125 x 22,23 mm	7 mm	12.200 /min	1 piece / 10 pieces	628556000
230 x 22,23 mm	7 mm	6.600 /min	1 piece / 10 pieces	628557000

Flap disc »ZK«

- Quality class zirconia alumina
- Suitable for rough and intermediate grinding in all fields of metalworking including stainless steel, steel, cast iron, and sheet steel
- Most suitable for processing stainless steels
- Uniformly high grinding capacity and uniform grinding finish



Sample sales display

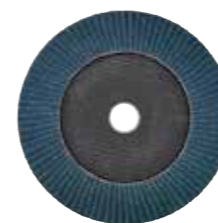

Diameter x bore	Grit	Version	Maximum speed	Sales unit / sales display	Order no.
115 x 22,23 mm	P 40	—	13.300 /min	1 piece / 10 pieces	623144000
115 x 22,23 mm	P 60	—	13.300 /min	1 piece / 10 pieces	623145000
115 x 22,23 mm	P 80	—	13.300 /min	1 piece / 10 pieces	623146000
115 x 22,23 mm	P 120	—	13.300 /min	1 piece / 10 pieces	623153000
125 x 22,23 mm	P 40	—	12.200 /min	1 piece / 10 pieces	623147000
125 x 22,23 mm	P 60	—	12.200 /min	1 piece / 10 pieces	623148000
125 x 22,23 mm	P 80	—	12.200 /min	1 piece / 10 pieces	623149000
125 x 22,23 mm	P 120	—	12.200 /min	1 piece / 10 pieces	623154000
178 x 22,23 mm	P 40	—	8.500 /min	1 piece / 10 pieces	623150000
178 x 22,23 mm	P 60	—	8.500 /min	1 piece / 10 pieces	623151000
178 x 22,23 mm	P 80	—	8.500 /min	1 piece / 10 pieces	623152000

Jigsaw blade assortment

- For wood, metal and plastics
- HCS saw blades/HSS saw blades



Sample sales display

Jigsaw blade assortment "SP", 10 pieces	Contents	Sales unit / sales display	Order no.
	1x 623646000 basic wood 51/ 2.0 mm, HCS, corresponds to T 119 BO 1x 623634000 clean wood 74/ 2.5 mm, HCS, corresponds to T 101 B 2x 623631000 basic wood 51/ 2.0 mm, HCS, corresponds to T 119 B 2x 623633000 fast wood 74/ 4.0 mm, HCS, corresponds to T 144 D 1x 623632000 basic wood 74/ 3.0 mm, HCS, corresponds to T 111 C 1x 623639000 expert aluminium 74/ 3.0 mm, HSS, corresponds to T 127 D 1x 623638000 basic metal 51/ 2.0 mm, HSS, corresponds to T 118 B 1x 623637000 basic metal 51/ 1.2 mm, HSS, corresponds to T118 A	1 piece / 10 pieces	623599000

Router bit assortment

- Carbide cutting edges guarantee a long service life
- Different router bit geometries permit cutting a variety of profiles in different materials



Sample sales display

Router assortment, 6 pieces	Contents	Sales unit / sales display	Order no.
	Straight bit (2 pieces): Ø 8 mm; Ø 12 mm Core box bit (1 piece): Ø 12.7 mm, R 6.3 mm Rounding-over bit with ball bearing (1 piece): Ø 21.8 mm, R 6.3 mm Multi-radius ogee bit with ball bearing (1 piece): Ø 25 mm, R 4.5 mm V straight bit (1 piece): Ø 12.7 mm, 14°	1 piece / 6 pieces	631040000

Router assortment, 15 pieces	Contents	Sales unit / sales display	Order no.
	Straight bits (4 pieces): Ø 6 mm; Ø 10 mm; Ø 12 mm; Ø 16 mm Core box bits (3 pieces): Ø 12.7 mm, R 6.3 mm; Ø 9.5 mm, R 4.8 mm; Ø 21.8 mm, R 6.3 mm Chamfer/bevelling tool (1 piece): Ø 31.5 mm, 45° V-straight bit (1 piece): Ø 12.7 mm, 90° Rounding-over bits (2 pieces): Ø 28.1 mm, R 9.5 mm; Ø 21.8 mm, R 6.3 mm Bevelling tool (1 piece): Ø 12.7 mm Dovetailing bit (1 piece): Ø 12.7 mm, 14° Multi-radius ogee bit (1 piece): Ø 25 mm, R 4.5 mm Rebating bit (1 piece): Ø 22.2 mm	1 piece / 6 pieces	631039000

Accessory modules: Well thought out in detail.

The high quality of the Metabo accessory program, plus an optimal presentation warrant a successful and lucrative accessory business.

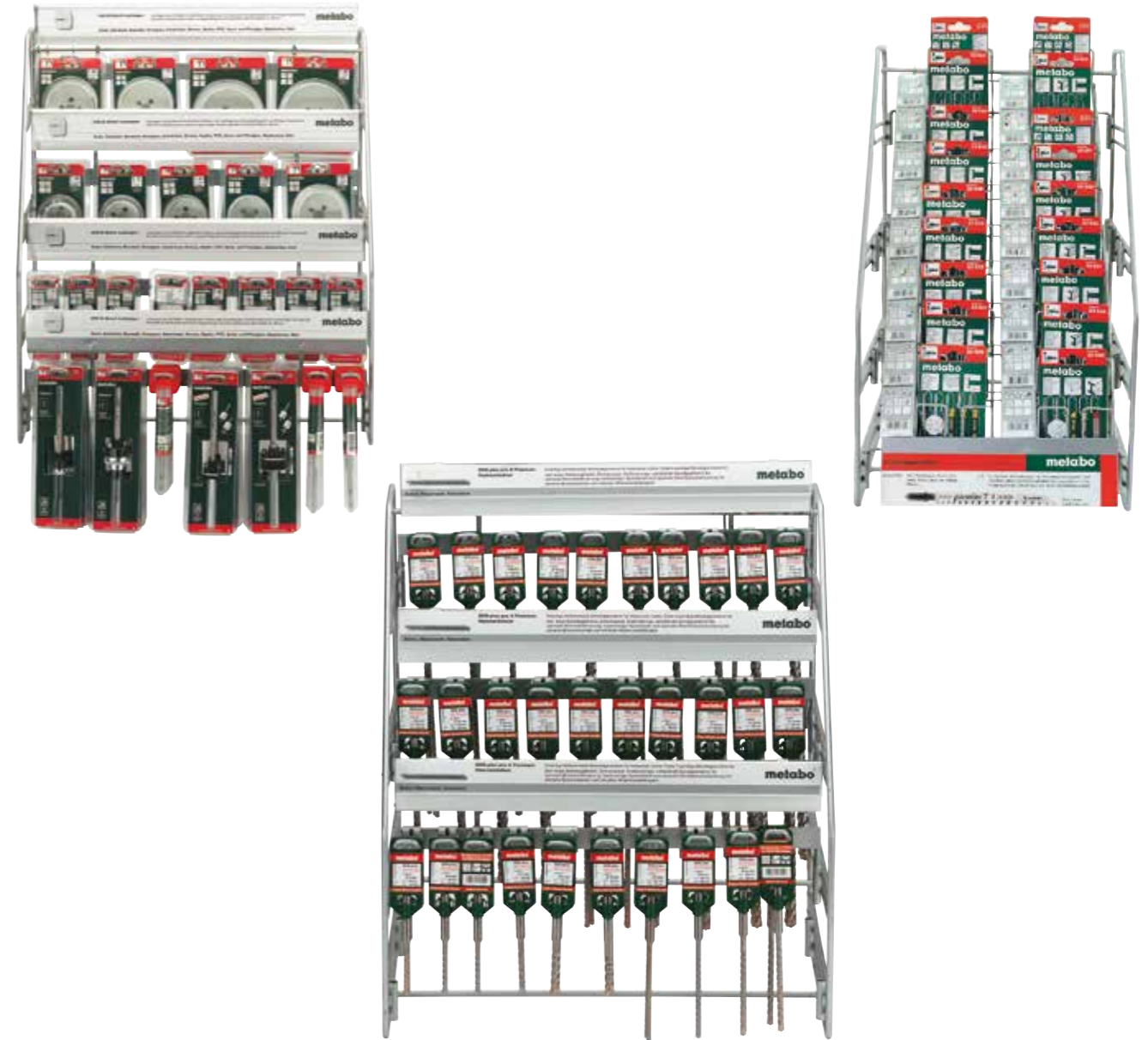

- Attractive sales modules for high-turnover product areas, e.g. drills, hole saws, jigsaw blades
- Lockable sales cabinets for drills
- Clear product information with colour system on the head bands
- Behind the hinged head band, clear article designation with EAN Code, Order No., dimensions and price range. Thus quick identification of product and reordering without problem.
- Flexible hook system and safe fit of the products
- Presentation option on any wall, in the Metabo accessory presentation system or counter display
- Always within the visual focus of the customer
- Self service vendor system

17
18
19
20
21
22
23
24
25
26
27
28
29
30
31
32

Drill bit modules, module size 49 x 60 x 36 cm

Metal drill bit, HSS-G
Standard components 144 pieces
Order no. 690073000

Metal drill bits, HSS-Co
Standard components 168 pieces
Order no. 690074000

Ø x GL mm	Units	Order no.
1,0 x 34	5	627950000
1,5 x 40	5	627951000
2,0 x 49	5	627952000
2,5 x 57	5	627953000
3,0 x 61	10	627954000
3,2 x 65	5	627955000
3,5 x 70	5	627957000
4,0 x 75	10	627958000
4,2 x 75	5	627960000
4,5 x 80	5	627961000
4,8 x 86	5	627962000
5,0 x 86	10	627963000
5,5 x 93	5	627966000
6,0 x 93	10	627967000
6,5 x 101	5	627968000
6,8 x 109	3	627969000
7,0 x 109	5	627970000
7,5 x 109	3	627971000
8,0 x 117	10	627973000
8,5 x 117	5	627975000
9,0 x 125	3	627976000
9,5 x 125	3	627977000
10,0 x 133	5	627978000
10,5 x 133	2	627980000
11,0 x 142	2	627981000
11,5 x 142	2	627982000
12,0 x 151	2	627983000
12,5 x 151	2	627984000
13,0 x 151	2	627985000

Ø x GL mm	Units	Order no.
1,0 x 34	10	627430000
1,5 x 40	5	627431000
2,0 x 49	10	627432000
2,5 x 57	5	627433000
3,0 x 61	10	627435000
3,2 x 65	10	627436000
3,3 x 65	10	627437000
3,5 x 70	5	627438000
4,0 x 75	10	627439000
4,2 x 75	5	627441000
4,5 x 80	5	627442000
4,8 x 86	5	627443000
5,0 x 86	10	627444000
5,5 x 93	5	627447000
6,0 x 93	10	627448000
6,5 x 101	5	627449000
7,0 x 109	5	627451000
7,5 x 109	3	627452000
8,0 x 117	10	627454000
8,5 x 117	5	627456000
9,0 x 125	3	627457000
9,5 x 125	3	627458000
10,0 x 133	5	627459000
10,2 x 133	2	627460000
10,5 x 133	2	627461000
11,0 x 142	2	627462000
11,5 x 142	2	627463000
12,0 x 151	2	627464000
12,5 x 151	2	627465000
13,0 x 151	2	627466000



Drill bit modules, module size 49 x 60 x 36 cm

Universal wood drill bits
Standard components 126 pieces
Order no. 690076000

Flat timber drill bits, wood drill bits, Forstner drill bits
Standard components 92 pieces
Order no. 690080000

Ø x GL mm	Units	Order no.
4,0 x 85	5	627680000
5,0 x 85	5	627681000
6,0 x 100	10	627683000
6,0 x 150	10	627684000
8,0 x 120	5	627688000
8,0 x 250	5	627689000
10,0 x 120	3	627691000
10,0 x 250	3	627692000
12,0 x 150	3	627693000
12,0 x 250	3	627694000
3,0 x 61	5	627986000
4,0 x 75	5	627987000
5,0 x 86	5	627988000
6,0 x 93	10	627989000
7,0 x 109	3	627990000
8,0 x 117	10	627991000
9,0 x 120	2	627992000
10,0 x 133	10	627993000
11,0 x 142	2	627994000
12,0 x 151	6	627995000
13,0 x 151	2	627996000
14,0 x 151	4	627997000
15,0 x 160	2	627998000
16,0 x 160	4	627999000
18,0 x 180	2	627339000
20,0 x 200	2	627340000

Ø x GL mm	Units	Order no.
10,0 x 160	3	627312000
12,0 x 160	3	627313000
14,0 x 160	3	627315000
16,0 x 160	3	627316000
18,0 x 160	3	627317000
20,0 x 160	3	627319000
25,0 x 160	3	627322000
26,0 x 160	3	627323000
30,0 x 160	3	627325000
36,0 x 160	3	627327000
3,0 x 61	5	627986000
4,0 x 75	5	627987000
5,0 x 86	5	627988000
6,0 x 93	5	627989000
8,0 x 117	5	627991000
10,0 x 133	5	627993000
12,0 x 151	3	627995000
14,0 x 151	3	627997000
16,0 x 160	3	627999000
18,0 x 180	3	627339000
10,0 x 90	2	627579000
12,0 x 90	2	627580000
14,0 x 90	2	627581000
15,0 x 90	2	627582000
20,0 x 90	2	627585000
25,0 x 90	2	627588000
26,0 x 90	2	627589000
30,0 x 90	2	627591000
35,0 x 90	2	627594000
36,0 x 90	2	627595000



Concrete drill bit »pro«
Standard components 93 pieces
Order no. 690083000

Concrete drill bit »classic«
Standard components 93 pieces
Order no. 690084000

SDS-Plus drill bit, pro 4
Standard components 120 pieces
Order no. 690086000

SDS Plus drill bit, pro 4 »PREMIUM«
Standard components 160 pieces
Order no. 690424000

Ø x GL mm	Units	Order no.
4,0 x 75	5	627224000
5,0 x 85	10	627225000
5,5 x 85	3	627226000
6,0 x 100	10	627227000
6,5 x 100	3	627228000
7,0 x 100	5	627229000
8,0 x 120	10	627230000
9,0 x 120	3	627389000
10,0 x 120	10	627391000
11,0 x 150	2	627392000
12,0 x 150	3	627393000
13,0 x 150	2	627394000
14,0 x 150	2	627395000
15,0 x 150	2	627396000
16,0 x 150	2	627399000
18,0 x 160	2	627409000
20,0 x 160	2	627410000
5,0 x 150	3	627421000
6,0 x 150	3	627423000
8,0 x 200	3	627426000
10,0 x 200	3	627427000
12,0 x 200	3	627428000
14,0 x 200	2	627429000

Ø x GL mm	Units	Order no.
4,0 x 75	5	627625000
5,0 x 85	10	627626000
5,5 x 85	3	627627000
6,0 x 100	10	627646000
6,5 x 100	3	627650000
7,0 x 100	5	627651000
8,0 x 120	10	627652000
9,0 x 120	3	627653000
10,0 x 120	10	627654000
11,0 x 150	2	627655000
12,0 x 150	3	627656000
13,0 x 150	2	627657000
14,0 x 150	2	627658000
15,0 x 150	2	627659000
16,0 x 150	2	627661000
18,0 x 160	2	627662000
20,0 x 160	2	627664000
5,0 x 150	3	627665000
6,0 x 150	3	627675000
8,0 x 200	3	627679000
10,0 x 200	3	627697000
12,0 x 200	3	627698000
14,0 x 200	2	627699000

Ø x GL mm	Units	Order no.
5,0 x 110	5	631820000
5,0 x 160	5	631821000
6,0 x 110	10	631824000
6,0 x 160	10	631825000
6,0 x 210	5	631826000
8,0 x 110	5	631832000
8,0 x 160	10	631833000
8,0 x 210	5	631834000
8,0 x 260	3	631835000
10,0 x 110	10	631837000
10,0 x 160	10	631838000
10,0 x 210	5	631839000
10,0 x 260	2	631840000
10,0 x 310	2	631841000
12,0 x 160	5	631844000
12,0 x 210	5	631845000
12,0 x 260	2	631846000
14,0 x 160	5	631849000
14,0 x 210	3	631850000
14,0 x 260	2	631851000
14,0 x 310	2	631852000
16,0 x 160	5	631854000
16,0 x 210	2	631855000
16,0 x 310	2	631856000

Ø x GL mm	Units	Order no.
5,0 x 110	5	626200000
5,0 x 160	5	626201000
5,5 x 110	3	626202000
5,5 x 160	3	626203000
6,0 x 110	8	626204000
6,0 x 160	8	626205000
6,0 x 210	8	626206000
6,0 x 260	8	626207000
6,0 x 310	3	626208000
6,5 x 160	3	626209000
6,5 x 210	3	626210000
6,5 x 260	3	626211000
7,0 x 110	3	626213000
7,0 x 160	3	626214000
8,0 x 110	8	626215000
8,0 x 160	8	626216000
8,0 x 210	8	626217000
8,0 x 260	8	626218000
10,0 x 110	8	626219000
10,0 x 160	8	626220000
10,0 x 210	8	626221000
10,0 x 260	8	626222000
10,0 x 310	5	626223000
12,0 x 160	5	626225000
12,0 x 210	5	626226000
12,0 x 260	3	626227000
12,0 x 310	3	626228000
14,0 x 160	3	626230000
14,0 x 210	3	626231000
14,0 x 310	3	626232000

Forstner drill bit
Standard components 45 pieces
Order no. 690081000

Auger Bits
Standard components 78 pieces
Order no. 690078000

Concrete »classic«, wood HSS-G drill bits
Standard components 134 pieces
Order no. 690085000

Flat timber drill bits, glass drill bits
Standard components 75 pieces
Order no. 690077000

Ø x GL mm	Units	Order no.
10,0 x 90	3	627579000
12,0 x 90	3	627580000
14,0 x 90	3	627581000
15,0 x 90	3	627582000
16,0 x 90	3	627583000
18,0 x 90	3	627584000
20,0 x 90	3	627585000
22,0 x 90	2	627586000
24,0 x 90	2	627587000
25,0 x 90	2	627588000
26,0 x 90	2	627589000
28,0 x 90	2	627590000
30,0 x 90	2	627591000
32,0 x 90	2	627592000
34,0 x 90	2	627593000
35,0 x 90	2	627594000
36,0 x 90	2	627595000
38,0 x 90	2	627596000
40,0 x 90	2	627597000

Ø x GL mm	Units	Order no.
8,0 x 230	3	627124000
10,0 x 230	5	627125000
12,0 x 230	5	627126000
14,0 x 230	5	627127000
16,0 x 230	5	627128000
18,0 x 230	2	627129000
20,0 x 230	2	627130000
22,0 x 230	2	627131000
24,0 x 230	2	627132000
26,0 x 230	2	627133000
28,0 x 230	2	627134000
30,0 x 230	2	627135000
32,0 x 230	2	627136000
8,0 x 460	3	627137000
10,0 x 460	5	627138000
12,0 x 460	5	627139000
14,0 x 460	5	627140000
16,0 x 460	5	627141000
18,0 x 460	2	627142000
20,0 x 460	2	627143000
22,0 x 460	2	627144000
24,0 x 460	2	627145000
26,0 x 460	2	627146000
28,0 x 460	2	627147000
30,0 x 460	2	627148000
32,0 x 460	2	627150000

Ø x GL mm	Units	Order no.
4,0 x 75	5	627625000
5,0 x 85	5	627626000
6,0 x 100	5	627646000
6,0 x 150		

Drill bit cabinets HSS-R



Drill bit cabinet, small

- In the smallest of spaces (37,5 x 23,5 x 20,5 cm) the most important and most powerful HSS drill bits, roll-milled version

Contents	Order no.
29 dimensions with a total of 490 bits: Ø 1.0–13.0 mm, 0.5 mm ascending, in addition Ø 3.2 mm, 4.2 mm, 4.8 mm, 6.8 mm	690103000



Drill bit cabinet, large

- The most important and most powerful HSS bits, roll-milled version

Contents	Order no.
90 dimensions with a total of 865 drill-bits: Ø 1.0–9.0 mm, 0.1 mm ascending Ø 9.00–13.0 mm, 0.5 mm ascending, additional 10.2 mm	690106000

Drill bit cabinets HSS-G

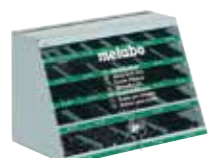

Drill bit cabinet, small

- In the smallest of spaces (37,5 x 23,5 x 20,5 cm) the most important and most powerful HSS drill bits, ground version

Contents	Order no.
29 dimensions with total 410 bits: Ø 1.0 - 13.0 mm: 0.5 mm ascending in addition Ø 3.2 mm, 4.2 mm, 4.8 mm, 6.8 mm	690104000

Hole saw module



HSS Bi-metal hole saws
Standard components 58 pieces
Order no. 690425000

Designation	Ø mm	Pieces	Order no.
	19	2	625163000
	20	2	625164000
	25	2	625168000
	29	2	625170000
	32	2	625172000
	35	2	625174000
	38	2	625176000
	40	2	625177000
	44	2	625180000
	51	2	625184000
	57	2	625188000
	60	2	625190000
	64	2	625191000
	68	2	625194000
	76	2	625197000
	83	2	625199000
	95	2	625203000
Pilot drill, (6,35 mm)		8	625220000
adapter SW9 (14-30 mm)		8	625215000
adapter SW11 (32-152 mm)		8	625216000

Jigsaw blade module



Small jigsaw blade module
Standard components 180 pieces
Order no. 690101000

Corresponding Bosch type	Useable length mm	Tooth pitch mm	Units	Order no.
T 119 BO	50	1,2	10	623646000
T 119 B	50	2	10	623631000
T 111 C	75	3	10	623632000
T 144 D	75	4	10	623633000
T 244 D	75	4	10	623649000
T 101 D	75	4	10	623635000
T 101 B	75	2,5	10	623634000
T 301 CD	85	3	10	623654000
T 234 X	90	progr.	10	623675000
Assortment			10	623645000
T 118 G	50	0,7	10	623636000
T 118 A	50	1,2	10	623637000
T 118 B	50	2	10	623638000
T 127 D	75	3	10	623639000
T 118 AF	50	1,2	10	623971000
T 318 A	100	1,2	10	623629000
T 123 X	75	progr.	10	623676000
T 345 XF	105	progr.	10	623677000

Jigsaw blade module



Large jigsaw blade module
Standard components 270 pieces
Order no. 690105000

Corresponding Bosch type	Useable length mm	Tooth pitch mm	Units	Order no.
T 119 BO	50	1,2	10	623646000
T 119 B	50	2	10	623631000
T 111 C	75	3	10	623632000
T 144 D	75	4	10	623633000
T 244 D	75	4	10	623649000
T 144 DP	75	4	10	623694000
T 101 D	75	4	10	623635000
T 101 BR	75	2,5	10	623650000
T 101 B	75	2,5	10	623634000
T 101 AO	50	1,35	10	623651000
T 301 CLF	105	3	10	623977000
T 301 CD	85	3	10	623654000
T 234 X	90	progr.	10	623675000
Assortment			10	623645000
T 118 G	50	0,7	10	623636000
T 118 A	50	1,2	10	623637000
T 218 A	50	1,2	10	623647000
T 118 B	50	2	10	623638000
T 127 D	75	3	10	623639000
T 101 A	75	2	10	623640000
T 118 AF	50	1,2	10	623971000
T 118 EF	50	1,5	10	623972000
T 118 BF	50	2	10	623973000
T 127 DF	75	3	10	623974000
T 318 A	100	1,2	10	623629000
T 123 X	75	progr.	10	623676000
T 345 XF	105	progr.	10	623677000

Order No.	Page	Order No.	Page	Order No.	Page	Order No.	Page	Order No.	Page	Order No.	Page	Order No.	Page	Order No.	Page	Order No.	Page	Order No.	Page	Order No.	Page	Order No.	Page
600890000	140	616230000	16	616560000	20	623036000	105	623238000	99	623331000	98	623479000	60	623596000	180	623696000	174	623950000	176	624058000	207	624304000	36
612001000	140	616270000	15	616561000	20	623038000	105	623239000	99	623333000	98	623480000	60	623597000	180	623697000	175	623960000	172	624059000	207	624306000	35
612003000	140	616271000	15	616563000	20	623106000	294	623240000	99	623334000	98	623481000	60	623599000	298	623698000	178	623961000	173	624060000	209	624307000	35
616100000	15	616273000	15	616572000	20	623107000	78	623241000	99	623337000	98	623482000	60	623600000	178	623703000	173	623962000	173	624061000	207	624308000	35
616101000	15	616274000	15	616573000	20	623112000	24	623242000	99	623338000	98	623483000	60	623603000	172	623704000	173	623964000	172	624063000	78	624309000	35
616102000	15	616275000	20	616604000	21	623114000	24	623243000	99	623339000	98	623484000	60	623604000	176	623710000	31	623965000	175	624064000	206	624310000	35
616103000	15	616277000	20	616610000	21	623115000	24	623245000	99	623340000	98	623485000	60	623605000	172	623711000	31	623968000	178	624066000	209	624346000	27
616104000	15	616279000	20	616622000	21	623116000	97	623249000	99	623341000	98	623486000	60	623606000	172	623712000	172	623969000	173	624081000	210	624347000	27
616105000	15	616285000	17	616654000	21	623117000	97	623252000	99	623342000	98	623487000	60	623607000	172	623715000	31	623970000	176	624082000	210	624356000	25
616107000	15	616286000	17	616660000	21	623118000	97	623253000	99	623344000	98	623488000	60	623608000	173	623719000	31	623971000	176	624083000	210	624358000	25
616109000	15	616290000	21	616672000	21	623119000	97	623255000	99	623345000	98	623494000	60	623609000	173	623729000	246	623973000	176	624084000	210	624359000	25
616111000	15	616291000	21	616680000	20	623120000	97	623256000	99	623347000	98	623495000	59	623617000	174	623740000	78	623974000	178	624085000	210	624391000	14
616115000	15	616292000	21	616725000	20	623121000	97	623257000	99	623349000	98	623496000	59	623618000	175	623741000	78	623975000	174	624086000	210	624392000	24
616119000	15	616299000	15	616726000	20	623122000	97	623259000	140	623350000	98	623499000	61	623620000	176	623742000	78	623976000	174	624087000	210	624393000	24
616121000	14	616300000	14	616727000	14	623123000	97	623262000	52	623351000	104	623501000	62	623621000	175	623751000	263	623977000	174	624088000	210	624394000	24
616123000	14	616302000	14	616728000	18	623124000	97	623263000	99	623352000	104	623503000	62	623622000	178	623752000	263	623978000	176	624092000	77	624395000	24
616126000	17	616303000	18	616729000	21	623125000	97	623264000	99	623353000	104	623505000	62	623623000	175	623757000	263	623979000	176	624101000	28	624396000	24
616127000	14	616310000	14	616730000	20	623128000	97	623265000	78	623354000	104	623506000	62	623624000	172	623758000	263	623980000	174	624102000	28	624397000	24
616135000	18	616312000	18	616731000	21	623129000	97	623268000	99	623355000	104	623507000	61	623629000	175	623759000	263	623998000	173	624103000	28	624398000	24
616136000	18	616313000	14	616732000	14	623130000	97	623271000	108	623356000	104	623508000	61	623631000	172	623760000	263	623999000	174	624104000	28	624475000	25
616137000	18	616327000	19	616733000	18	623131000	97	623272000	77	623357000	104	623509000	61	623632000	172	623767000	109	624001000	208	624105000	28	624477000	25
616143000	18	616328000	19	616735000	21	623132000	97	623273000	77	623358000	104	623510000	61	623633000	172	623768000	109	624002000	208	624106000	28	624478000	25
616147000	18	616338000	19	616737000	15	623140000	52	623275000	29	623359000	104	623511000	62	623634000	173	623770000	108	624003000	208	624122000	28	624480000	212
616163000	15	616339000	19	616738000	15	623144000	297	623276000	52	623365000	104	623512000	59	623635000	173	623796000	31	624004000	208	624123000	28	624481000	212
616167000	15	616343000	19	616739000	21	623145000	297	623278000	29	623366000	104	623513000	60	623636000	175	623796700	31	624005000	208	624124000	28	624482000	212
616170000	22	616346000	19	616741000	15	623146000	297	623279000	29	623367000	104	623514000	60	623637000	175	623801000	31	624006000	208	624135000	28	624483000	212
616171000	22	616347000	16	616742000	14	623147000	297	623280000	29	623368000	104	623519000	59	623638000	175	623803000	31	624007000	208	624136000	28	624484000	212
616177000	22	616358000	296	616744000	15	623148000	297	623281000	29	623369000	104	623520000	61	623639000	178	623804000	31	624008000	208	624137000	28	624485000	212
616180000	16	616359000	296	616745000	20	623149000	297	623282000	29	623370000	105	623521000	132	623640000	176	623805000	31	624019000	208	624138000	28	624486000	212
616181000	16	616420000	14	616747000	21	623150000	297	623283000	29	623371000	108	623522000	61	623641000	178	623823000	97	624020000	208	624139000	28	624490000	213
616182000	16	616429000	20	616748000	21	623151000	297	623284000	29	623375000	105	623524000	61	623645000	178	623824000	98	624021000	208	624141000	28	624491000	213
616183000	16	616442000	14	616749000	21	623152000	297	623287000	77	623376000	105	623525000	61	623646000	172	623825000	98	624022000	208	624142000	28	624492000	213
616184000	16	616444000	14	616751000	17	623153000	297	623288000	77	623377000	105	623526000	60	623647000	175	623826000	98	624023000	208	624143000	28	624493000	213
616185000	16	616446000	14	616752000	17	623154000	297	623289000	77	623378000	105	623527000	60	623648000	178	623827000	98	624024000	208	624145000	28	624495000	213
616186000	16	616447000	14	616753000	17	623175000	24	623290000	30	623379000	105	623528000	60	623649000	172	623828000	98	624025000	208	624160000	28	624496000	213
616187000	16	616448000	14	616760000	21	623176000	24	623291000	30	623380000	105	623529000	63	623650000	173	623829000	98	624026000	208	624218000	28	624497000	213
616188000	15	616450000	14	616763000	21	623177000	24	623292000	30	623381000	105	623530000	63	623651000	172	623830000	98	624027000	208	624219000	28	624729000	214
616189000	15	616452000	14	616770000	14	623178000	24	623298000	57	623382000	105	623531000	138	623652000	177	623831000	98	624028000	210	624220000	28	624737000	214
616191000	15	616454000	14	616792000	21	623193000	98	623299000	106	623383000	104	623536000	63	623654000	173	623834000	173	624029000	210	624221000	28	624738000	214
616192000	15	616456000	14	616795000	21	623194000	98	623300000	27	623384000	104	623537000	63	623657000	177	623835000	173	624030000	210	624223000	28	624739000	207
616195000	18	616457000	14	616796000	21	623195000	24	623309000	294	623385000	104	623538000	63	623658000	177	623836000	175	624031000	210	624224000	28	624740000	206
616196000	18	616460000	20	622971000	28	623196000	24	623310000	97	623386000	104	623539000	63	623662000	177	623837000	176	624032000	210	624226000	28	624826000	213
616202000	19	616462000	20	622972000	28	623197000	24	623311000	97	623387000	104	623541000	63	623663000	177	623862000	81	624033000	210	624227000	28	624827000	213
616203000	19	616464000	20	622973000	28	623198000	24	623312000	97	623391000	106	623542000	59	623664000	180	623867000	81	624034000	210	624228000	28	624828000	213
616204000	19	616465000	20	622974000	28	623211000	98	623313000	97	623392000	106	623545000	165	623665000	181	623905000	179	624035000	210	624239000	24	624830000	213
616208000	16	616468000	20	622975000	28	623212000	98	623314000	97	623393000	106	623546000	165	623669000	181	623906000	179	624036000	210	624241000	24	624831000	213
616209000	16	616477000																					

Order No.	Page	Order No.	Page	Order No.	Page	Order No.	Page	Order No.	Page	Order No.	Page	Order No.	Page	Order No.	Page	Order No.	Page	Order No.	Page	Order No.	Page	Order No.	Page
624947000	195	625126000	134	625214000	137	625599000	218	625792000	212	626174000	91	626236000	95	626323000	65	626420000	195	626539000	144	626632000	30	626715000	290
624958000	196	625128000	134	625215000	137	625600000	217	625793000	212	626175000	91	626237000	94	626344000	66	626421000	196	626540000	144	626633000	30	626716000	290
624959000	196	625129000	134	625216000	137	625601000	218	625795000	213	626176000	91	626238000	95	626345000	66	626427000	198	626541000	144	626640000	223	626717000	290
624964000	77	625130000	134	625217000	137	625602000	218	625881000	214	626177000	91	626239000	95	626346000	66	626428000	198	626556000	188	626641000	223	626721000	289
624965000	77	625149000	92	625218000	137	625603000	216	625882000	214	626178000	91	626240000	94	626347000	66	626429000	198	626557000	188	626642000	223	626723000	291
624967000	77	625150000	125	625220000	137	625604000	216	625883000	214	626179000	91	626241000	94	626348000	66	626452000	30	626559000	189	626643000	223	626724000	296
624968000	77	625156000	92	625224000	106	625605000	216	625885000	214	626180000	91	626243000	91	626349000	66	626453000	30	626560000	189	626644000	223	626725000	292
624970000	220	625157000	92	625225000	253	625606000	216	625886000	214	626181000	91	626244000	91	626350000	66	626454000	30	626563000	192	626645000	223	626726000	291
624971000	220	625158000	91	625229000	92	625607000	216	625887000	214	626182000	91	626245000	95	626351000	66	626455000	30	626565000	191	626646000	223	626728000	293
624972000	220	625159000	138	625230000	93	625608000	216	625888000	214	626183000	91	626246000	95	626352000	66	626456000	30	626566000	186	626647000	223	626729000	293
624980000	195	625160000	136	625231000	93	625609000	216	625891000	214	626184000	91	626247000	95	626353000	66	626457000	30	626567000	186	626648000	223	626730000	50
624981000	195	625161000	136	625232000	93	625610000	216	625892000	214	626185000	91	626248000	95	626354000	66	626460000	25	626568000	186	626649000	223	626731000	51
624982000	195	625162000	136	625233000	93	625611000	217	625893000	214	626186000	91	626249000	95	626355000	66	626461000	25	626569000	186	626650000	223	626732000	51
624983000	195	625163000	136	625234000	93	625612000	217	625894000	214	626187000	91	626268000	95	626360000	66	626462000	25	626571000	145	626651000	223	626733000	51
624984000	195	625164000	136	625235000	93	625613000	217	625895000	214	626188000	91	626269000	95	626361000	66	626463000	25	626572000	145	626652000	223	626734000	147
624985000	195	625165000	136	625236000	93	625614000	217	625896000	214	626189000	91	626270000	95	626362000	66	626464000	25	626573000	145	626653000	223	626735000	147
624986000	195	625166000	136	625237000	93	625615000	217	625897000	214	626190000	91	626271000	95	626363000	66	626482000	26	626574000	145	626654000	223	626736000	147
624987000	195	625167000	136	625238000	93	625616000	217	625898000	214	626191000	91	626272000	95	626368000	26	626483000	26	626575000	145	626655000	223	626737000	147
624988000	195	625168000	136	625239000	93	625617000	217	625928000	221	626192000	91	626273000	95	626369000	26	626488000	25	626576000	145	626656000	223	626738000	147
624989000	250	625169000	136	625240000	93	625618000	217	625929000	221	626193000	91	626274000	95	626370000	26	626489000	25	626577000	145	626657000	224	626739000	147
624990000	250	625170000	136	625241000	93	625619000	212	625930000	221	626194000	91	626275000	95	626371000	27	626490000	25	626578000	145	626658000	224	626741000	147
624991000	250	625171000	136	625242000	93	625620000	212	625931000	221	626195000	91	626276000	95	626372000	27	626491000	25	626579000	145	626659000	223	626742000	147
624992000	220	625172000	136	625243000	93	625621000	212	625932000	221	626196000	91	626277000	95	626373000	27	626492000	25	626580000	145	626660000	223	626743000	147
624994000	220	625173000	136	625244000	93	625622000	212	625933000	221	626197000	91	626278000	95	626374000	27	626500000	144	626581000	145	626661000	224	626744000	147
624995000	220	625174000	136	625245000	93	625623000	212	625940000	221	626198000	91	626279000	64	626375000	27	626501000	144	626582000	145	626662000	224	626745000	147
624996000	220	625175000	136	625246000	93	625624000	212	625941000	221	626199000	91	626280000	64	626376000	67	626502000	144	626583000	145	626663000	224	626752000	51
625006000	121	625176000	136	625247000	93	625625000	212	625942000	221	626200000	94	626281000	64	626377000	67	626503000	144	626584000	145	626664000	224	626755000	211
625007000	121	625177000	136	625248000	93	625641000	214	625944000	221	626201000	94	626282000	64	626378000	67	626504000	144	626585000	145	626665000	224	626756000	209
625009000	121	625178000	136	625249000	92	625643000	214	626117000	94	626202000	94	626283000	64	626379000	67	626505000	144	626586000	145	626666000	224	626770000	31
625011000	121	625179000	136	625250000	92	625644000	214	626118000	94	626203000	94	626284000	64	626380000	67	626506000	144	626587000	145	626667000	209	626771000	31
625013000	121	625180000	137	625251000	92	625645000	214	626119000	95	626204000	94	626285000	64	626381000	67	626507000	144	626588000	145	626668000	209	626778000	32
625015000	121	625181000	137	625253000	92	625646000	214	626120000	95	626205000	94	626286000	64	626382000	67	626508000	144	626589000	145	626669000	209	626790000	141
625017000	121	625182000	137	625254000	92	625657000	214	626121000	95	626206000	94	626289000	65	626383000	66	626509000	144	626590000	145	626670000	209	626815000	32
625019000	121	625184000	137	625255000	92	625658000	206	626122000	95	626207000	94	626291000	65	626384000	66	626510000	144	626591000	145	626678000	209	626816000	32
625020000	132	625185000	137	625256000	91	625681000	195	626123000	95	626208000	94	626292000	65	626386000	66	626511000	144	626592000	145	626679000	209	626848000	208
625021000	132	625186000	137	625257000	91	625682000	195	626124000	95	626209000	94	626293000	65	626387000	66	626512000	144	626593000	145	626680000	209	626849000	208
625022000	132	625187000	137	625258000	91	625683000	195	626125000	95	626210000	94	626294000	65	626388000	66	626513000	144	626594000	145	626681000	209	626850000	208
625023000	132	625188000	137	625259000	92	625685000	195	626126000	95	626211000	94	626295000	65	626390000	66	626514000	144	626595000	145	626682000	209	626851000	208
625024000	132	625189000	137	625344000	250	625686000	195	626127000	95	626212000	94	626296000	65	626391000	67	626515000	144	626596000	145	626683000	211	626852000	208
625025000	132	625190000	137	625349000	250	625687000	195	626128000	95	626213000	94	626297000	65	626392000	67	626516000	144	626597000	145	626684000	211	626853000	208
625026000	251	625191000	137	625367000	250	625688000	195	626148000	78	626214000	94	626298000	65	626394000	67	626517000	144	626598000	145	626685000	211	626854000	208
625027000	251	625192000	137	625368000	250	625726000	210	626150000	29	626215000	94	626299000	65	626395000	58	626518000	144	626599000	145	626686000	211	626855000	208
625028000	251	625193000	137	625369000	250	625727000	210	626151000	29	626216000	94	626300000	64	626398000	67	626519000	144	626600000	146	626687000	211	626856000	208
625031000	123	625194000	137	625406000	251	625728000	210	626152000	29	626217000	94	626301000	64	626399000	78	626520000	144	626602000	146	626688000	211	626857000	210
625033000	123	625195000	137	625419000	148	625730000	210	626153000	29	626218000	94	626302000	64	626400000	58	626521000	144	626603000	146	626689000	211	626858000	210
625038000	123	625196000	137	625434000	138	625731000	210	626154000	29	626219000	94	626303000	64	626401000	58	62652200							

Order No.	Page	Order No.	Page	Order No.	Page	Order No.	Page	Order No.	Page	Order No.	Page	Order No.	Page	Order No.	Page	Order No.	Page	Order No.	Page	Order No.	Page	Order No.	Page
626884000	256	627007000	135	627156000	295	627328000	135	627451000	124	627591000	134	627699000	127	627761000	120	627948000	122	628016000	157	628105000	158	628282000	162
626885000	256	627008000	135	627157000	295	627329000	135	627452000	124	627592000	134	627700000	119	627762000	120	627949000	122	628017000	157	628108000	158	628283000	160
626886000	256	627009000	135	627158000	120	627330000	125	627454000	124	627593000	134	627701000	119	627763000	120	627950000	122	628018000	157	628109000	158	628284000	156
626887000	256	627010000	135	627159000	121	627331000	125	627456000	124	627594000	134	627702000	119	627764000	120	627951000	122	628020000	157	628110000	158	628285000	162
626888000	256	627012000	135	627160000	120	627332000	125	627457000	124	627595000	134	627703000	119	627765000	120	627952000	122	628023000	157	628205000	38	628286000	162
626889000	256	627013000	135	627161000	120	627333000	125	627458000	124	627596000	134	627704000	119	627766000	120	627953000	122	628024000	157	628206000	39	628287000	164
626890000	256	627037000	136	627162000	120	627334000	125	627459000	124	627597000	134	627705000	119	627767000	120	627954000	122	628025000	157	628207000	107	628288000	163
626891000	256	627038000	136	627164000	120	627335000	125	627460000	124	627598000	134	627706000	119	627768000	120	627955000	122	628026000	160	628208000	39	628289000	164
626892000	256	627039000	136	627171000	125	627336000	125	627461000	124	627599000	134	627707000	119	627769000	120	627957000	122	628027000	160	628209000	38	628290000	158
626894000	257	627040000	106	627173000	125	627337000	125	627462000	124	627601000	139	627708000	119	627770000	120	627958000	122	628028000	168	628214000	87	628291000	158
626895000	257	627041000	106	627179000	135	627338000	125	627463000	124	627608000	139	627709000	119	627771000	120	627960000	122	628029000	167	628215000	88	628292000	156
626897000	257	627042000	106	627180000	128	627339000	132	627464000	124	627609000	75	627710000	119	627772000	120	627961000	122	628030000	155	628216000	51	628293000	161
626898000	260	627043000	106	627181000	128	627340000	132	627465000	124	627621000	139	627711000	119	627773000	120	627962000	122	628031000	158	628218000	88	628294000	155
626899000	260	627044000	252	627182000	128	627343000	117	627466000	124	627623000	127	627712000	119	627774000	120	627963000	122	628034000	158	628219000	88	628295000	155
626902000	101	627064000	252	627185000	129	627347000	134	627467000	127	627625000	127	627713000	119	627775000	120	627966000	122	628035000	159	628220000	157	628296000	163
626903000	101	627077000	117	627190000	135	627354000	76	627468000	127	627626000	127	627714000	119	627776000	120	627967000	122	628037000	159	628221000	159	628297000	164
626904000	101	627088000	136	627191000	125	627355000	245	627469000	127	627627000	127	627715000	119	627777000	120	627968000	122	628040000	159	628222000	159	628298000	37
626905000	101	627093000	252	627192000	127	627360000	52	627470000	127	627640000	139	627716000	119	627778000	120	627969000	122	628041000	159	628223000	161	628299000	37
626911000	101	627096000	122	627193000	127	627361000	52	627471000	127	627641000	198	627717000	119	627779000	120	627970000	122	628042000	159	628224000	159	628300000	40
626912000	101	627097000	122	627200000	132	627362000	52	627473000	127	627642000	198	627718000	119	627780000	120	627971000	122	628043000	159	628225000	159	628301000	40
626913000	101	627098000	123	627202000	132	627378000	252	627474000	127	627643000	198	627719000	119	627785000	120	627972000	121	628044000	159	628226000	162	628302000	40
626914000	101	627100000	140	627203000	116	627389000	128	627476000	127	627644000	198	627720000	119	627790000	120	627973000	122	628045000	159	628227000	159	628303000	40
626915000	101	627107000	76	627224000	128	627391000	128	627478000	127	627646000	127	627721000	119	627792000	120	627974000	121	628046000	159	628228000	159	628304000	40
626916000	101	627108000	253	627225000	128	627392000	128	627480000	127	627650000	127	627722000	119	627795000	120	627975000	122	628048000	159	628229000	159	628305000	40
626917000	101	627111000	133	627226000	128	627393000	128	627487000	127	627651000	127	627723000	119	627800000	120	627976000	122	628049000	159	628230000	157	628306000	40
626918000	101	627112000	123	627227000	128	627394000	128	627490000	127	627652000	127	627724000	119	627805000	120	627977000	122	628051000	159	628241000	190	628307000	40
626919000	101	627115000	133	627228000	128	627395000	128	627491000	127	627653000	127	627725000	119	627810000	120	627978000	122	628053000	159	628242000	190	628308000	40
626920000	101	627116000	133	627229000	128	627396000	128	627492000	127	627654000	127	627726000	119	627815000	120	627979000	123	628056000	159	628244000	190	628309000	40
626921000	101	627119000	124	627230000	128	627399000	128	627493000	127	627655000	127	627727000	119	627820000	120	627980000	122	628057000	159	628245000	190	628310000	40
626922000	101	627120000	124	627232000	116	627401000	125	627495000	252	627656000	127	627728000	119	627852000	121	627981000	122	628058000	159	628246000	188	628311000	40
626923000	101	627121000	124	627234000	117	627402000	125	627514000	123	627657000	127	627729000	119	627857000	121	627982000	122	628059000	159	628247000	188	628312000	40
626924000	101	627122000	124	627235000	116	627403000	125	627515000	123	627658000	127	627730000	119	627862000	121	627983000	122	628060000	160	628248000	188	628313000	40
626925000	101	627124000	133	627237000	117	627404000	125	627516000	123	627659000	127	627731000	119	627867000	121	627984000	122	628061000	160	628250000	189	628314000	40
626926000	101	627125000	133	627238000	117	627405000	125	627517000	123	627661000	128	627732000	119	627872000	121	627985000	122	628062000	160	628251000	185	628315000	40
626943000	196	627126000	133	627240000	116	627409000	128	627518000	123	627662000	128	627733000	119	627874000	121	627986000	132	628063000	161	628252000	185	628316000	40
626944000	196	627127000	133	627241000	117	627410000	128	627519000	123	627664000	128	627734000	119	627875000	121	627987000	132	628064000	160	628253000	185	628317000	41
626945000	193	627128000	133	627242000	117	627421000	128	627522000	133	627665000	127	627735000	119	627877000	121	627988000	132	628065000	156	628254000	185	628318000	40
626946000	193	627129000	133	627243000	129	627423000	128	627523000	133	627666000	295	627736000	119	627882000	121	627989000	132	628066000	162	628255000	187	628319000	41
626947000	194	627130000	133	627244000	129	627426000	128	627524000	133	627667000	295	627737000	119	627883000	121	627990000	132	628070000	161	628256000	187	628320000	41
626948000	194	627131000	133	627245000	129	627427000	128	627525000	133	627668000	295	627738000	119	627884000	121	627991000	132	628071000	156	628257000	187	628321000	41
626949000	194	627132000	133	627246000	129	627428000	128	627526000	133	627669000	295	627739000	119	627887000	121	627992000	132	628072000	158	628258000	187	628322000	41
626950000	193	627133000	133	627247000	129	627429000	128	627527000	133	627670000	295	627740000	119	627890000	121	627993000	132	628073000	161	628259000	189	628325000	160
626951000	193	627134000	133	627256000	116	627430000	124	627528000	133	627671000	295	627741000	119	627892000	121	627994000	132	628075000	161	628260000	186	628326000	160
626952000	193	627135000	133	627259000	116	627431000	124	627534000	129	627672000	295	627742000	119	627893000	121	627995000	132	628076000	161	628261000	186	628327000	41
626953000	193	627136000	133	627261000	117	627432000	124	627535000	129	627675000	127	627743000	119	627894000	121	627996000	132	628077000	161	628262000	186	628328000	41
62																							

Order No.	Page	Order No.	Page	Order No.	Page	Order No.	Page	Order No.	Page	Order No.	Page	Order No.	Page	Order No.	Page	Order No.	Page	Order No.	Page	Order No.	Page	Order No.	Page
628346000	70	628409000	104	628538000	149	628653000	160	628791000	246	628895000	258	629060000	81	630194000	75	630390000	50	630705000	53	630992000	103	631230000	208
628347000	70	628410000	104	628539000	149	628654000	156	628797000	281	628896000	258	629061000	81	630195000	75	630401000	49	630706000	53	631001000	221	631231000	208
628348000	70	628411000	104	628540000	147	628655000	162	628798000	281	628897000	259	629062000	81	630201000	82	630403000	239	630709000	53	631002000	221	631232000	209
628349000	70	628412000	103	628541000	150	628656000	160	628799000	286	628898000	259	629063000	81	630202000	83	630412000	49	630714000	76	631003000	221	631233000	211
628350000	70	628413000	104	628542000	150	628657000	160	628800000	280	628899000	259	629064000	81	630203000	83	630413000	239	630715000	76	631004000	221	631235000	218
628351000	70	628414000	293	628543000	150	628658000	162	628801000	280	628900000	200	629065000	81	630212000	237	630419000	288	630719000	53	631005000	221	631236000	208
628352000	70	628423000	247	628544000	150	628659000	160	628802000	279	628901000	259	629066000	81	630213000	237	630442000	151	630725000	22	631006000	221	631248000	226
628353000	70	628424000	248	628551000	35	628660000	155	628803000	283	628902000	259	629067000	81	630231000	239	630463000	151	630726000	22	631007000	221	631249000	181
628354000	70	628425000	248	628552000	35	628661000	162	628804000	285	628903000	259	629068000	81	630239000	82	630467000	203	630727000	22	631008000	221	631281000	108
628355000	70	628426000	248	628553000	35	628662000	160	628805000	283	628904000	259	629069000	81	630241000	82	630468000	203	630777000	80	631019000	167	631285000	108
628356000	70	628427000	248	628554000	35	628663000	162	628806000	277	628905000	259	629088000	80	630243000	83	630474000	248	630778000	80	631020000	167	631286000	217
628357000	70	628428000	247	628555000	36	628664000	160	628807000	277	628906000	259	629089000	80	630244000	234	630475000	248	630779000	80	631031000	166	631287000	218
628358000	70	628429000	247	628556000	36	628665000	156	628808000	277	628907000	259	629090000	80	630245000	234	630477000	93	630784000	80	631034000	221	631288000	217
628359000	70	628430000	247	628557000	36	628666000	162	628809000	277	628908000	259	629091000	80	630247000	83	630478000	103	630785000	80	631039000	298	631289000	217
628360000	70	628432000	247	628558000	35	628667000	162	628810000	277	628909000	259	629092000	80	630256000	239	630484000	103	630788000	80	631040000	298	631317000	199
628361000	70	628433000	247	628559000	35	628668000	163	628811000	277	628910000	259	629093000	80	630259000	206	630486000	293	630789000	80	631041000	82	631327000	199
628362000	70	628434000	247	628560000	35	628669000	163	628812000	277	628911000	259	629094000	80	630260000	207	630488000	104	630792000	53	631042000	82	631333000	199
628363000	70	628435000	247	628561000	35	628675000	160	628813000	277	628912000	259	629095000	80	630261000	206	630489000	104	630796000	85	631052000	141	631337000	231
628364000	70	628442000	164	628562000	35	628676000	160	628814000	277	628913000	259	629096000	80	630262000	206	630519000	92	630798000	233	631074000	141	631340000	180
628365000	71	628443000	164	628563000	35	628677000	157	628815000	277	628914000	260	629097000	81	630263000	207	630526000	92	630800000	53	631078000	139	631341840	108
628366000	71	628444000	155	628564000	35	628678000	157	628816000	284	628915000	260	629098000	81	630264000	206	630527000	92	630802000	53	631080000	185	631341890	108
628367000	71	628445000	155	628570000	36	628679000	160	628817000	284	628916000	260	629099000	81	630272000	228	630528000	92	630814000	50	631093000	185	631343000	108
628368000	71	628446000	164	628571000	36	628680000	160	628818000	285	628917000	260	629102000	80	630275000	236	630531000	93	630820000	225	631094000	188	631345000	237
628369000	71	628447000	164	628572000	36	628700000	271	628820000	269	628918000	260	629103000	80	630282000	228	630532000	93	630821000	75	631095000	185	631348000	237
628370000	71	628448000	164	628573000	36	628701000	271	628821000	280	628919000	260	629104000	80	630296000	236	630533000	93	630824000	294	631096000	185	631360000	78
628371000	71	628492000	156	628574000	36	628702000	271	628822000	278	628920000	260	629105000	80	630298000	236	630536000	93	630829000	108	631097000	188	631362000	231
628372000	70	628493000	156	628575000	36	628703000	271	628823000	278	628921000	260	629106000	80	630299000	237	630537000	93	630832000	53	631098000	188	631363000	233
628373000	70	628494000	159	628576000	36	628704000	271	628824000	269	628922000	260	629175300	22	630311000	238	630538000	93	630833000	75	631110000	74	631364000	232
628374000	70	628495000	161	628577000	36	628705000	271	628828000	150	628923000	260	629178000	103	630312000	232	630539000	93	630835000	53	631111000	74	631365000	233
628375000	71	628500000	148	628578000	37	628706000	271	628829000	150	628924000	260	629179000	103	630314000	233	630540000	93	630841000	242	631112000	74	631369000	218
628376000	71	628501000	148	628579000	37	628707000	271	628831000	151	628925000	260	629180000	105	630316000	232	630541000	93	630850000	198	631114000	221	631370000	232
628377000	71	628502000	148	628580000	37	628708000	271	628832000	150	628926000	260	629181000	105	630317000	232	630542000	93	630851000	198	631120000	190	631387000	103
628378000	71	628503000	149	628600000	215	628720000	272	628833000	151	628926000	260	630000000	243	630320000	233	630545000	203	630852000	198	631122000	190	631388000	103
628379000	74	628504000	149	628602000	215	628721000	272	628834000	151	628963000	263	630001000	243	630321000	234	630548000	93	630853000	198	631125000	188	631407000	188
628380000	74	628506000	149	628603000	215	628722000	272	628835000	151	628965000	262	630002000	243	630322000	233	630549000	93	630854000	198	631129000	185	631420000	103
628381000	74	628507000	149	628604000	215	628730000	272	628837000	150	628966000	263	630003000	243	630323000	234	630550000	141	630855000	198	631130000	185	631421000	103
628382000	74	628508000	149	628605000	215	628731000	272	628838000	150	628968000	262	630004000	243	630324000	234	630551000	141	630858000	198	631137000	191	631422000	103
628383000	74	628509000	149	628606000	215	628732000	272	628843000	150	628969000	262	630005000	243	630325000	236	630552000	141	630859000	41	631139000	190	631424000	103
628384000	74	628510000	149	628607000	215	628733000	272	628845000	150	628970000	262	630006000	243	630326000	238	630554000	141	630867000	233	631141000	190	631425000	103
628385000	74	628511000	149	628608000	215	628734000	272	628847000	150	628971000	262	630007000	243	630327000	52	630570000	244	630868000	234	631144000	192	631449000	103
628386000	74	628512000	149	628609000	215	628735000	272	628848000	276	629003000	200	630011000	243	630328000	234	630571000	244	630885000	245	631146000	191	631454000	185
628387000	74	628513000	148	628610000	215	628736000	271	628849000	149	629004000	202	630022000	243	630329000	234	630572000	244	630886000	245	631150000	206	631456000	103
628388000	74	628514000	148	628611000	215	628737000	272	628850000	149	629005000	202	630105000	225	630343000	236	630573000	244	630887000	245	631156000	206	631458000	190
628389000	74	628515000	148	628612000	215	628738000	271	628875000	257	629006000	202	630106000	225	630344000	85	630574000	244	630889000	245	631190000	221	631470000	190
628391000	74	628516000	148	628613000	215	628739000	272	628876000	257	629007000	202	630118000	225	630351000	49	630576000	244	630891000	245	631191000	221	631472000	190
628392000	74	628517000	148	628615000	215	628740000	273	628877000	257	629008000													

Order No.	Page	Order No.	Page	Order No.	Page	Order No.	Page	Order No.	Page	Order No.	Page	Order No.	Page	Order No.	Page	Order No.	Page	Order No.	Page
631586000	208	631825000	92	631934000	238	635202000	213	636617000	111	0901025967	272	0901053855	276	0903061243	283	0911030748	203	7809009283	274
631587000	208	631826000	92	631937000	238	635203000	213	636619000	111	0901025975	272	0901053863	276	0903061251	283	0911030845	203	7809009291	274
631588000	208	631827000	92	631938000	168	635204000	214	636620000	111	0901025983	271	0901053871	276	0903061260	282	0911050390	203	7809035764	274
631589000	208	631828000	92	631939000	181	635205000	216	636621000	111	0901025991	271	0901053880	276	0903061278	282	0911053179	203	7823672327	277
631595000	109	631829000	92	631940000	234	635206000	216	636624000	111	0901026017	272	0901053898	276	0903061294	280	0911060167	203	7851194171	266
631596000	208	631830000	92	631943000	107	635207000	216	636625000	111	0901026025	272	0901053901	276	0903061316	285	0911062119	203	7851194180	266
631597000	208	631831000	92	631945000	75	635208000	216	642395000	114	0901026041	274	0901054568	269	0903061340	286	0911063549	203	7854112915	241
631599000	228	631832000	92	631946000	75	635209000	216	642396000	114	0901026050	274	0901054584	265	0903061359	281	0913005058	240	7854115035	241
631618000	151	631833000	92	631947000	75	635210000	216	657006000	261	0901026068	274	0901054908	268	0903061367	281	0913007123	240	7876193943	266
631629000	237	631834000	92	631948000	75	635211000	216	657007000	261	0901026076	274	0901054916	268	0903061375	280	0913010779	241	7876193951	266
631660000	228	631835000	92	631949000	225	635212000	216	685048000	253	0901026084	274	0901054924	268	0903061677	279	0913013565	241	7876193978	267
631665000	237	631836000	92	631967000	237	635213000	216	685049000	253	0901026092	274	0901054932	268	0903061685	279	0913013581	240	7876193986	267
631670000	248	631837000	92	631968000	107	635214000	216	685050000	253	0901026106	274	0901054940	268	0903063122	287	0913014626	240	7876193994	267
631690000	93	631838000	92	631980000	218	635215000	216	685051000	253	0901026130	273	0901054959	268	0903063130	287	0913014634	240	7876194001	266
631703000	95	631839000	92	631981000	218	635216000	216	685064000	253	0901026149	273	0901054967	268	0903063149	287	0913017617	240	7876194010	266
631704000	95	631840000	92	631984000	189	635217000	216	685065000	253	0901026157	273	0901054975	269	0903064838	279	0913031270	242	7876194028	266
631705000	95	631841000	92	631986000	189	635218000	216	685069000	254	0901026173	273	0901054983	275	0903064846	279	0913031288	241	7876194060	266
631706000	95	631842000	92	631987000	189	635219000	217	685074000	254	0901026190	273	0901054991	275	0903064854	279	0913031296	242	7876194079	266
631707000	95	631843000	92	631989000	187	635252000	113	685077000	254	0901026203	273	0901055769	277	0909000416	198	0913031300	242	7876194117	267
631708000	95	631844000	92	631991000	186	635253000	113	685122000	254	0901026220	274	0901056048	268	0909000424	198	0913059433	241	7876194125	266
631709000	95	631845000	92	631992000	186	635254000	113	685130000	254	0901026238	274	0901056056	268	0909029171	198	0913059441	240	7876194133	266
631710000	95	631846000	92	631993000	186	635255000	113	685131000	254	0901026246	274	0901056161	268	0909029180	198	0920016529	240	7876693610	267
631711000	95	631847000	92	635000000	49	635302000	113	685132000	254	0901026254	274	0901056218	268	0909029210	198	0920054030	203	7876693628	267
631712000	95	631848000	92	635008000	113	635304000	113	685133000	254	0901026262	277	0901056226	268	0909029228	198	0920054048	203	9109691680	267
631713000	95	631849000	92	635019000	113	636215000	111	685135000	254	0901026289	274	0901057290	268	0909029244	198	1001672319	277		
631715000	93	631850000	92	635033000	113	636216000	111	685136000	254	0901026319	275	0901057303	268	0909029252	198	1319706247	278		
631720000	228	631851000	92	635036000	113	636217000	111	685142000	254	0901026327	278	0901058903	268	0909029260	198	4313062258	204		
631751000	231	631852000	92	635049000	113	636219000	113	685143000	254	0901026351	271	0901059489	267	0909029279	198	7710672339	277		
631752000	231	631853000	92	635050000	113	636225000	111	685160000	254	0901026360	271	0901059500	267	0909030528	199	7800009035	271		
631753000	238	631854000	92	635054000	113	636226000	111	685161000	253	0901026378	275	0901059691	266	0909030536	199	7800009043	271		
631756000	241	631855000	92	635056000	113	636227000	111	685163000	254	0901026386	275	0901062145	268	0909030544	199	7800009558	271		
631780000	91	631856000	92	635058000	113	636241000	111	685180000	254	0901026408	278	0901063087	278	0909030552	199	7801009055	270		
631785000	92	631864000	91	635072000	113	636242000	111	685300000	253	0901026521	278	0901063095	278	0909031249	199	7801009063	270		
631788000	92	631866000	92	635104000	114	636243000	111	685301000	253	0901026530	278	0901063109	278	0909040817	198	7801009071	270		
631789000	92	631868000	92	635105000	114	636321000	112	690073000	300	0901026548	278	0901063788	265	0909040825	198	7802009083	270		
631793000	92	631876000	92	635114000	114	636322000	112	690074000	300	0901026572	278	0901063796	265	0909040841	198	7802009091	270		
631794000	92	631879000	92	635115000	114	636323000	112	690076000	301	0901026645	270	0901063800	265	0909052939	198	7802009105	270		
631797000	92	631894000	238	635116000	114	636333000	112	690077000	301	0901026653	270	0901063818	265	0909057175	198	7803009117	271		
631800000	109	631907000	192	635125000	114	636341000	112	690078000	301	0901026661	277	0901063826	264	0909057183	198	7803009125	272		
631801000	92	631909000	187	635126000	114	636342000	112	690080000	301	0901026777	275	0901063834	264	0909057191	198	7803009133	271		
631802000	92	631910000	190	635128000	114	636343000	112	690081000	301	0901026807	275	0901063850	264	0909060257	198	7803009141	272		
631803000	92	631911000	187	635132000	114	636351000	112	690083000	300	0901026815	277	0901063869	264	0909060265	198	7804009161	272		
631804000	93	631912000	189	635133000	114	636353000	112	690084000	300	0901026858	277	0901063877	264	0909060273	198	7804010372	272		
631805000	93	631913000	190	635143000	114	636356000	112	690085000	301	0901026866	277	0901063885	264	0909060281	198	7804065606	272		
631806000	93	631914000	187	635144000	114	636361000	112	690086000	300	0901026882	277	0901064423	278	0909060303	199	7805009300	274		
631807000	93	631915000	189	635146000	114	636362000	112	690101000	303	0901026904	277	0903009250	284	0909060338	199	7805009319	274		
631808000	93	631916000	192	635165000	114	636363000	112	690103000	302	0901031517	270	0903014253	284	0909060346	199	7805009343	274		
631809000	93	631917000	192	635167000	114	636364000	112	690104000	302	0901031550	277	0903016450	284	0909060354	199	7805009351	274		
631810000	93	631918000	192	635168000	114	636515000	113	690105000	303	0901053715	276	0903018410	279	0910008749	200	7805009416	274		
631811000	93	631920000	107	635169000	114	636517000	113	690106000	302	0901053723	276	0903019352	280	0910031260	241	7805009432	274		
631812000	93	631921000	107	635190000	212	636518000	112	690424000	300	0901053731	276	0903019379	279	0910053353	204	7805009440	274		
631814000	93	631922000	107	635191000	212	636519000	112	690425000	303	0901053740	276	0903028351	285	0910058010	241	7805009459	274		
631815000	93	631923000	107	635192000	212	636520000	112	0901004170	264	0901053758	276	0903028360	285	0910058967	200	7805009475	274		
631816000	93	631924000	107	635193000	212	636601000	111	0901008540	265	0901053766	276	0903028416	285	0910059955	241	7805009483	274		
631817000	191	631925000	189	635194000	212	636602000	111	0901013047	278	0901053774	276	0903028432	285	0911001071	204				

Metabo - always close by.

With 2,000 employees, 25 subsidiary sales companies and 100 importers on all continents, we have a global presence on site - and always there whenever and wherever you need us.



Germany

Metabowerke GmbH
Metabo-Allee 1
72622 Nürtingen
Tel.: +49 (0)7022 72-0

United Kingdom

Metabo (UK) Ltd
25 Majestic Road,
Nursling Industrial Estate
Southampton SO16 0YT
Tel.: +44 (0) 2380 732000

Australia

Metabo Pty. Ltd.
10 Dalmore Drive
Scoresby, Victoria 3179
Tel.: +61 3 9765 0199
Fax: +61 3 9765 0189

Middle East

Metabo (Branch)
Office No. 423, Block 4EA
Dubai Airport Freezone
Tel.: +971 4 7017325

Metabo Power Tools SA (Pty) Ltd

165 Vanderbijl Street
Meadowdale
Germiston 1401
Johannesburg
Gauteng
South Africa
Tel.: +27 87 808 2200
Fax: +27 11 453 4163

China

Metabo Powertools (China) Co. Ltd.
Bldg. 7, 3585 San Lu Road
Pujiang Industrial Park
Min Hang District
Shanghai 201114
Tel.: (+86) 21 - 24 16 2688
Fax: (+86) 21 - 64 29 2999

As of 05 / 2021

www.metabo.com

metabo®

PROFESSIONAL POWER TOOL SOLUTIONS